

organizer 2025



Architectural design

**FLORIM**

# MADE IN FLORIM

## La ricerca della bellezza fa parte del patrimonio genetico dell'essere umano

In Florim questo istinto per la creatività si fonde con la passione e incontra la più moderna tecnologia produttiva per dar vita ad un nuovo tipo di prodotto. Un progetto morale non solo bello ma anche a basso impatto ambientale e pensato per far star bene le persone nel loro spazio. Abbiamo una lunga storia da raccontare e una gran voglia di guardare avanti in un futuro fatto di **bellezza, innovazione e sostenibilità**.

## *The pursuit of beauty is part of the human genetic heritage*

*At Florim, this instinct for creativity merges with passion and meets the most advanced production technology to create a new kind of product. A moral project that is not only beautiful but also environmentally friendly, designed to enhance well-being in personal spaces with a low environmental impact. We have a long story to tell and a strong desire to look forward to a future built on **beauty, innovation, and sustainability**.*

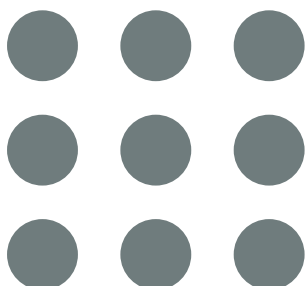



# ALTAGAMMA

## La bellezza e lo stile italiani nel mondo

Vocazione estetica, heritage culturale e forte identità sono alcuni degli elementi condivisi da Florim e Altagamma, la Fondazione che dal 1992 riunisce le **imprese ambasciatrici dello stile italiano nel mondo**. Una comunione di vedute che ha permesso a Florim di essere accolta nel 2022 come nuovo membro. La Fondazione racchiude l'élite delle aziende italiane votate all'**alto di gamma**: il segmento di mercato in costante crescita in tutto il mondo e nel quale il Made in Italy gioca un ruolo da protagonista. Altagamma riunisce i marchi più prestigiosi nei settori moda, design, gioielleria, alimentare, ospitalità, motori e nautica.

## *Italian beauty and style around the world*

*Aesthetic vocation, cultural heritage, and a strong identity are key elements shared by Florim and Altagamma, the foundation that since 1992 has brought together **companies that represent Italian style worldwide**. This shared vision led to Florim's induction as a new member in 2022. The Foundation includes the elite of Italian companies dedicated to the **high-end segment** - a market that continues to grow globally, where Made in Italy plays a leading role. Altagamma brings together the most prestigious brands in fashion, design, jewelry, food, hospitality, automotive, and yachting.*

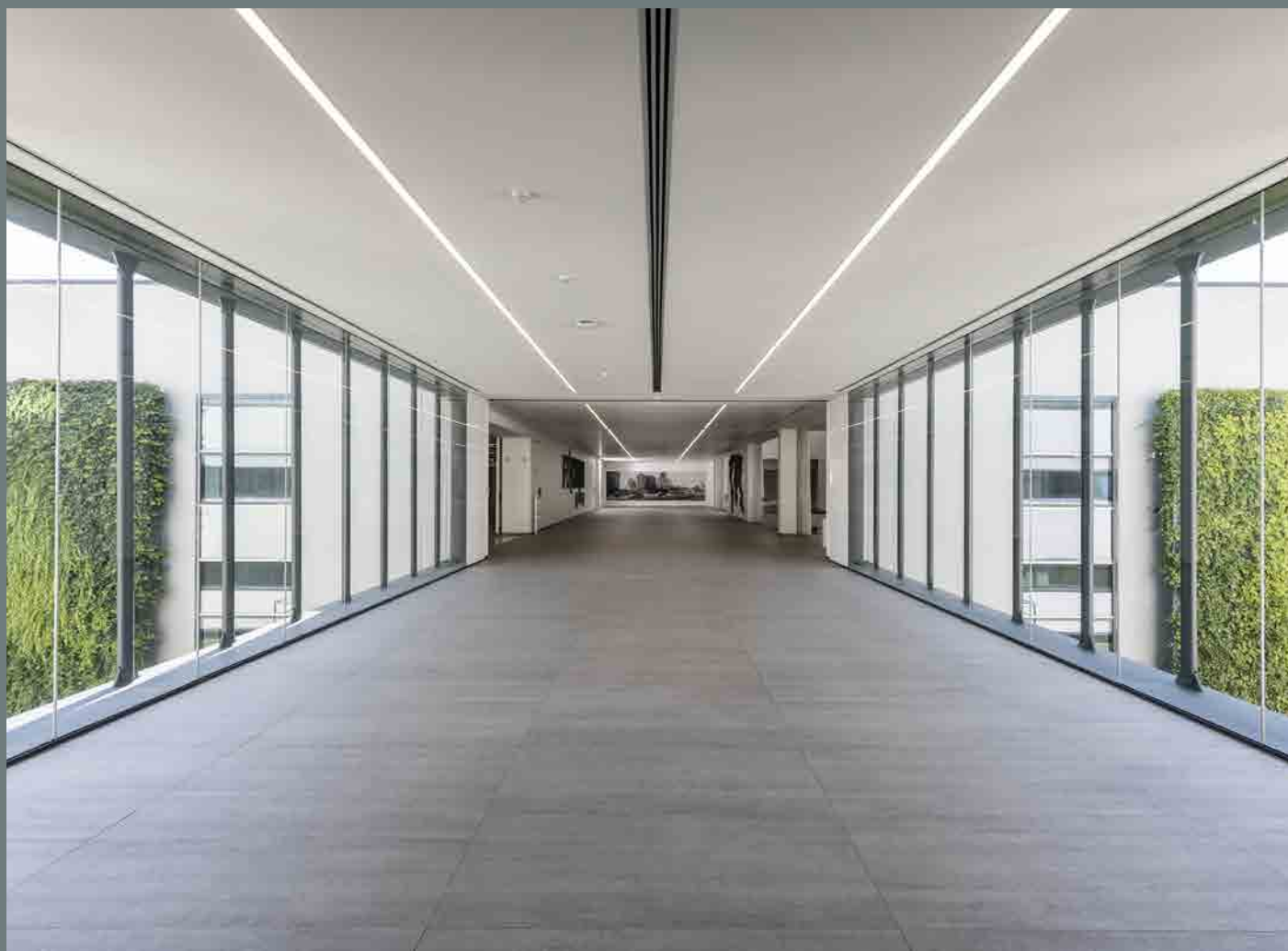

# I cinque elementi della nostra sostenibilità

## Acqua, aria, terra e fuoco

Consideriamo i quattro elementi naturali come risorse uniche e preziose perché dal loro equilibrio dipende la sopravvivenza degli ecosistemi.

Il nostro compito è quello di proteggerli attraverso azioni quotidiane che, sommate, fanno la differenza.

**Ci piace pensare alla persona come "quinto elemento"**, tassello determinante per cambiare lo stato di crisi del nostro pianeta attraverso gesti consapevoli e scelte responsabili. In Florim, le nostre persone sono ambasciatrici di un modo di fare attento e consapevole. Sono il nostro DNA, rappresentano una cultura aziendale fondata sul rispetto e la valorizzazione, che si estende a tutte le persone del territorio.

Un impegno verso le persone e l'ambiente che Florim ha preso molto seriamente, è scritto nel nostro statuto.

Certified



Corporation

Siamo **Società Benefit** e certificati **B Corp** dal 2020.

## ACQUA / *water*



**100%**  
riciclo delle acque  
reflue di produzione  
*100% recycling  
of greenware waste*

In Florim **tutte le acque reflue del ciclo produttivo sono riutilizzate al 100%**. Nei nostri stabilimenti sono presenti delle **vasche di raccolta dell'acqua piovana** che recuperano l'acqua proveniente dalle precipitazioni. Per ottimizzare l'utilizzo delle risorse idriche abbiamo introdotto delle innovative **linee di squadratura a secco** che eliminano l'acqua utilizzata per la rettifica del materiale.

*At Florim, **all wastewater from the production cycle is 100% reused.** Our facilities are equipped with **rainwater collection tanks** that capture water from precipitation. To optimize water resource usage, we have introduced innovative **dry squaring lines** that eliminate the need for water in the material rectification process.*

## ARIA / *air*



**100%**  
autoproduzione dell'energia  
elettrica necessaria  
*100% self-production of the  
required electrical energy*

Ci stiamo impegnando a ridurre al massimo le emissioni generate dal nostro processo e dal nostro prodotto. Possiamo contare su **127.000 mq di superfici ricoperte da impianti fotovoltaici** in grado di generare una potenza di picco di 12,3 MWp e due impianti di cogenerazione che ci permettono di autoprodotte fino al 100% dell'energia elettrica necessaria alle sedi italiane. Quando la luce del sole non basta, **acquistiamo energia elettrica** proveniente **esclusivamente da fonti rinnovabili certificate**.

*We are committed to minimizing emissions generated by our processes and products. We have **127,000 square meters of surfaces covered with photovoltaic** systems capable of generating a peak power of 12.3 MWp, along with two cogeneration plants that allow us to self-produce up to 100% of the electricity needed for our Italian facilities. When sunlight is not enough, **we purchase electricity exclusively from certified renewable sources.***





# The five elements of our sustainability

## Water, air, earth, and fire

**We conceive the four natural elements as unique and precious resources because the survival of ecosystems depends on their balance.**

*Our role is to protect them through daily actions that, when combined, make a difference.*

**We like to think of people as the "fifth element",** a crucial piece in changing the current crisis of our planet through conscious actions and responsible choices. At Florim, our people are ambassadors of a mindful and attentive way of working. They are our DNA, embodying a corporate culture rooted in respect and appreciation, extending to everyone in our community.

*This commitment to people and the environment is one that Florim takes very seriously—it's written into our bylaws.*

*We are a **Benefit Corporation** and have been certified as a **B Corp** since 2020.*

## TERRA / earth



Il nostro prodotto accoglie **oltre il 90% di materie prime di origine naturale** di altissima qualità. Ricicliamo il 100% degli scarti crudi di produzione e monitoriamo attentamente la catena di fornitura delle materie prime. I prodotti Florim accolgono **fino al 60% di materie prime riciclate**, la percentuale varia in base agli spessori e alle collezioni.

*Our products are made with **over 90% high-quality natural raw materials**. We recycle 100% of raw production waste and closely monitor our raw material supply chain. Florim products **contain up to 60% recycled raw materials**, with the percentage varying depending on thickness and collections.*

## FUOCO / fire



Il fuoco è l'elemento che cambia la materia e rende il prodotto ceramico **resistente** all'umidità, all'usura, agli agenti chimici e atmosferici. Il nostro gres viene cotto a circa 1200 gradi, questo lo rende un **materiale che dura nel tempo, sicuro e igienico**. Una qualità testimoniata da **numerose certificazioni di prodotto e processo**.

*Fire is the element that transforms matter, making ceramic products **resistant** to moisture, wear, and chemical and atmospheric agents. Our porcelain stoneware is fired at around 1200 degrees, **making it a durable, safe, and hygienic material**. This quality is backed by **numerous product and process certifications**.*

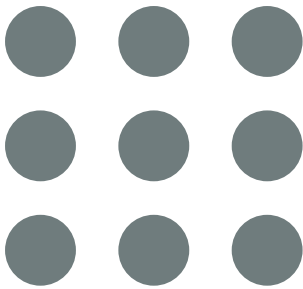

# CARBONZERO

## Le superfici Carbon Neutral di Florim

In linea con la nostra strategia che sposa un **paradigma di business a beneficio del pianeta**, dal 2023 promuoviamo CarbonZero: il progetto di superfici Carbon Neutral che compensano le emissioni di CO<sub>2</sub> generate dalla loro produzione e dal loro ciclo di vita.

### *Florim's Carbon Neutral surfaces*

*Aligned with our strategy of embracing a **business paradigm that benefits the planet**, in 2023 we launched CarbonZero: an initiative dedicated to Carbon Neutral surfaces that fully offset the CO<sub>2</sub> emissions produced throughout their manufacturing and lifecycle.*



**Scopri di più:**  
Find out more:





## Misuriamo

Abbiamo calcolato l'impatto ambientale delle nostre superfici **lungo il ciclo di vita del prodotto\*** perché vogliamo ridurre tutte le emissioni di CO<sub>2</sub>, anche quelle che avvengono al di fuori dell'azienda.

## We measure

*We have calculated the environmental impact of our surfaces **along the product life cycle** (\*) because we aim to reduce all CO<sub>2</sub> emissions, including those that occur outside.*

## Riduciamo

Per contenere le emissioni della nostra attività, **abbiamo ridotto l'uso di risorse naturali** e investito per rendere il processo produttivo **più sostenibile**: fino al 100% in termini di acqua, energia elettrica e recupero degli scarti crudi.

## We reduce

*To contain the emissions from our activity, **we have reduced the use of natural resources** and invested in making the production process **more sustainable**: up to 100% in terms of water, electricity, and raw waste recovery.*

## Compensiamo

**Promuoviamo un impatto positivo**: le collezioni CarbonZero **compensano tutta la CO<sub>2</sub> emessa durante il loro ciclo di vita**, supportando progetti certificati che producono energia pulita nei paesi in via di sviluppo. Il progetto CarbonZero unisce alla consueta bellezza e al design dei prodotti Florim l'impatto positivo dato dalla compensazione di CO<sub>2</sub>\*\*.

## We offset

***We promote a positive impact**: CarbonZero collections **offset all the CO<sub>2</sub> emitted during their life cycle**, supporting certified projects that produce clean energy in developing countries. The CarbonZero project combines beauty and design with the positive impact given by CO<sub>2</sub> offsetting (\*\*).*

(\*) dato certificato EPD – numero di registrazione EPDITALY0462

(\*\*) la compensazione avviene attraverso l'acquisto di crediti di carbonio CER (Certified Emission Reductions) sul registro CDM (Clean Development Mechanism) dell'UNFCCC (United Nations Framework for Climate Change). per il calcolo è stato utilizzato il valore di 19,05 kg di CO<sub>2</sub>-eq / m<sup>2</sup> con densità media di 21,97 kg/m<sup>2</sup> – dato calcolato partendo dal valore di GWP total (EPD Florim che considera l'intero ciclo di vita del prodotto) integrando le attività di manutenzione e pulizia ipotizzando una durata di 60 anni. Florim si impegna annualmente nel monitoraggio, riduzione e compensazione delle emissioni di gas ad effetto serra delle collezioni CarbonZero.

(\*) EPD certified data – registration number EPDITALY0462

(\*\*) Offsetting is achieved through the purchase of CER (Certified Emission Reductions) carbon credits on the CDM (Clean Development Mechanism) registry of the UNFCCC (United Nations Framework for Climate Change). For the calculation, a value of 19.05 kg of CO<sub>2</sub>-eq / m<sup>2</sup> with an average density of 21.97 kg/m<sup>2</sup> was used – this data was calculated starting from the total GWP value (EPD Florim that considers the entire life cycle of the product) integrating maintenance and cleaning activities assuming a lifespan of 60 years. Florim commits annually to monitoring, reducing, and offsetting the greenhouse gas emissions of the CarbonZero Collections.



---

# Architectural design

Materiale tecnico seguendo le tendenze dell'architettura, per applicazioni quali pavimentazioni industriali e realizzazioni pubbliche a medio e ad alto traffico, come aeroporti, centri commerciali, ristoranti, uffici, negozi, ma anche applicazioni residenziali con un mirato contenuto estetico.

Technical material in line with architectural trends, for applications such as industrial flooring and public buildings with medium to high footfall, such as airports, shopping centres, restaurants, offices, shops, as well as residential applications featuring a targeted aesthetic content.

Matériau technique suivant les tendances de l'architecture, pour des applications en tant que sols industriels et des réalisations publiques à trafic moyen et intense, comme les aéroports, les centres commerciaux, les restaurants, les bureaux, les magasins, mais aussi pour des applications résidentielles au contenu esthétique ciblé.

Technisches Material im Einklang mit den architektonischen Trends für Anwendungen wie Industrieböden und mittelhoch bis stark frequentierte öffentliche Bereiche wie Flughäfen, Einkaufszentren, Restaurants, Büros und Läden, aber auch für Wohngebäude mit wertiger Optik.

Material técnico que sigue las tendencias de la arquitectura, creado para pavimentos industriales y ambientes públicos de mediano y alto tránsito —como aeropuertos, centros comerciales, restaurantes, oficinas y tiendas—, pero también para aplicaciones residenciales con un refinado contenido estético.



## performance



## appeal



## project



## ecobuilding

---

# Indice



## **gres fine porcellanato**

fine porcelain stoneware / grès cérame fin  
feinsteinzeug-kollektionen / gres porcelánico fino

|                |               |
|----------------|---------------|
| <b>14/25</b>   | Biotech       |
| <b>26/33</b>   | B&W_Marble    |
| <b>34/43</b>   | Buildtech/2.0 |
| <b>50/59</b>   | Coretech      |
| <b>60/83</b>   | Earthtech     |
| <b>84/91</b>   | Flowtech      |
| <b>92/105</b>  | Industrial    |
| <b>106/121</b> | Plimatech     |
| <b>122/131</b> | Rawtech       |
| <b>132/141</b> | Stontech/4.0  |
| <b>142/151</b> | Walks/1.0     |

## **gres porcellanato decorato**

decorated porcelain tiles  
grès cérame décoré  
verziertes feinsteinzeug  
gres porcelánico decorado

|              |  |               |
|--------------|--|---------------|
| <b>44/49</b> |  | Buildtech/2.0 |
|--------------|--|---------------|



---

# La simbologia

SYMBOL/SYMBOLS/SYMBOL/SIMBOLOGIA

**DIN 16165 ANNEX B:** Scivolosità a piedi calzati: il materiale ceramico viene posto su un piano e oliato. Successivamente il piano viene progressivamente inclinato, mentre un operatore con scarpa di gomma cammina lungo il piano fino a quando non inizia a scivolare; la misura dell'angolo che si forma tra il piano inclinato e il suolo all'inizio dello scivolamento determina la classificazione del materiale. / Shod foot slipperiness: the ceramic material is placed on a surface and oiled. Subsequently, the surface is progressively tilted, while an operator with rubber shoes walks along the surface until he starts to slip; the measurement of the angle that is formed between the inclined surface and the ground when the slipping starts determines the classification of the material. / Glissance pieds chaussés : le matériau céramique est mis sur un plan et huilé. Le plan est ensuite incliné progressivement, tandis qu'un opérateur avec des chaussures en caoutchouc marche le long du plan jusqu'à ce qu'il ne commence à glisser ; la mesure de l'angle qui se forme entre le plan incliné et le sol au début du glissement donne la classification du matériau. / Rutschsicherheit auf Schuhen: Das Keramikmaterial wird auf einer Fläche angebracht und mit einem Gleitmittel bestrichen. Daraufhin wird die Fläche nach und nach geneigt, während eine Prüfperson mit Gummischuhen die Fläche entlangläuft, bis sie ins Rutschen gerät. Die Größe des Winkels, der zwischen der geneigten Fläche und dem Boden zu Beginn der Rutschbewegung entsteht, bestimmt die Klassifizierung des Materials. / Deslizamiento con pies descalzos: el material cerámico se coloca sobre un plano y se aceita. Seguidamente el plano se inclina progresivamente, mientras que un operador con calzado de goma camina a lo largo del plano hasta que empieza a resbalar; la medida del ángulo que se forma entre la superficie inclinada y el suelo al principio del deslizamiento determina la clasificación del material.

**DIN 16165 ANNEX A:** Scivolosità a piedi nudi: il materiale ceramico viene posto su un piano e bagnato. Successivamente il piano viene progressivamente inclinato, mentre un operatore con piede nudo cammina lungo il piano fino a quando non inizia a scivolare; la misura dell'angolo che si forma tra il piano inclinato e il suolo all'inizio dello scivolamento determina la classificazione del materiale. / Barefoot slipperiness: the ceramic material is placed on a surface and made wet. Subsequently, the surface is progressively tilted, while an operator with bare feet walks along the surface until he starts to slip; the measurement of the angle that is formed between the inclined plane and the ground when slipping starts determines the classification of the material. / Glissance pieds nus : le matériau céramique est mis sur un plan et mouillé. Le plan est ensuite incliné progressivement, tandis qu'un opérateur pieds nus marche le long du plan jusqu'à ce qu'il ne commence à glisser ; la mesure de l'angle qui se forme entre le plan incliné et le sol au début du glissement donne la classification du matériau. / Rutschsicherheit barfuß: Das Keramikmaterial wird auf einer Fläche angebracht und befeuchtet. Daraufhin wird die Fläche nach und nach geneigt, während eine Prüfperson barfuß die Fläche entlangläuft, bis sie ins Rutschen gerät. Die Größe des Winkels, der zwischen der geneigten Fläche und dem Boden zu Beginn der Rutschbewegung entsteht, bestimmt die Klassifizierung des Materials. / Deslizamiento con pies descalzos: el material cerámico se pone sobre un plano y se moja. Seguidamente el plano se inclina progresivamente, mientras que un operador con los pies descalzos camina a lo largo del plano hasta que empieza a resbalar; la medida del ángulo que se forma entre la superficie inclinada y el suelo al principio del deslizamiento determina la clasificación del material.

**DCOF:** Coefficiente di attrito dinamico: viene misurata la forza necessaria per mantenere in movimento un elemento (BOT 3000) rivestito in gomma dalla superficie della piastrella in condizioni di superficie bagnata; il rapporto tra la forza necessaria e il peso dell'elemento scivolante indica il Coefficiente di attrito dinamico. / Dynamic coefficient of friction: the force required to maintain the movement of an element (BOT 3000) coated with rubber on the surface of the tile in wet surface conditions is measured; the relationship between the force required and the weight of the slipping element indicates the dynamic coefficient of friction. / Coefficient de frottement dynamique : la force nécessaire pour maintenir en mouvement un élément (BOT 3000) revêtu en caoutchouc sur la surface du carreau en conditions de surface mouillée est mesurée ; la relation entre la force nécessaire et le poids de l'élément glissant indique le coefficient de frottement dynamique. / Dynamischer Reibungskoeffizient: Gemessen wird die Kraft, die erforderlich ist, um ein Element mit Gummiverkleidung (BOT 3000) durch die Fliese bei nasser Oberfläche in Bewegung zu halten. Das Verhältnis zwischen der erforderlichen Kraft und dem Gewicht des gleitenden Elements gibt den dynamischen Reibungskoeffizienten wieder. / Coeficiente de fricción cinética: se mide la fuerza necesaria para mantener en movimiento un elemento (BOT 3000) revestido de goma por la superficie de la baldosa bajo condiciones de superficie mojada; la relación entre la fuerza necesaria y el peso del elemento que resbala indica el Coeficiente de fricción dinámica.

---

## SQUADRATO / SQUARED / EQUARRI / REKTIFIZIERT / ESCUADRADO

Piastrelle o lastre ceramiche portate a dimensioni predefinite, ognuno esattamente uguale all'altra (monocalibro) con sistema di mole abrasive. Ceramic tiles or slabs made to a pre-defined size, each one exactly the same as the others (single size), using a system of abrasive grinders. / Carreaux ou dalles céramiques mises aux dimensions prédéfinies, parfaitement identiques l'une à l'autre (mono-calibre) grâce à un système de disques abrasifs. / Fliesen oder Keramikplatten mit festgelegten Formaten. Alle Fliesen sind aufgrund der Verwendung des Schleifscheiben-Systems hundertprozentig identisch (Monokaliber). / Baldosas o piezas de cerámica que se realizan con dimensiones predefinidas, cada pieza es exactamente igual a la otra (mono dimensión) con sistema de discos abrasivos.



# Grado di variazione cromatica

DEGREE OF COLOUR CHANGE/DEGRE DE VARIATION CHROMATIQUE/GRAD DER FARBABWEICHUNG/GRADO DE VARIACIÓN CROMÁTICA

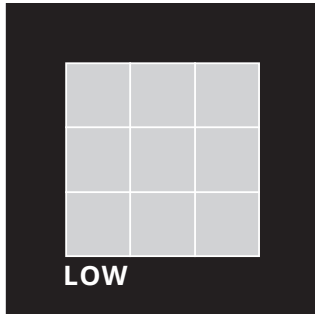

## v1

### PRODOTTO MONOCROMATICO.

The least amount of shade and texture variation.

Attainable in naturally fired clay products.

Produit monochromatique.

Eifarbiges produkt.

Producto monocromático.



## v2

### PRODOTTO CON LEGGERA VARIAZIONE CROMATICA.

Light to moderate shade and texture variation within each carton.

Produit à légère variation chromatique.

Produkt mit leichter farbnuance.

Producto con una pequeña variación cromática.



## v3

### PRODOTTO CON MARCATA VARIAZIONE CROMATICA.

High shade texture variation within each carton.

Produit à variation chromatique accentuée.

Produkt mit ausgeprägter farbnuance.

Producto con evidente variación cromática.

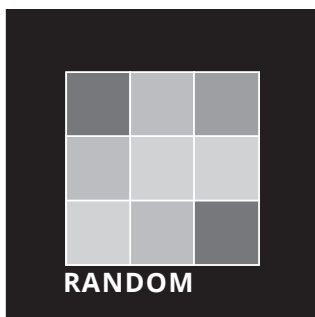

## v4

### PRODOTTO CON FORTE VARIAZIONE CROMATICA.

Very high shade and texture variation within each carton.

Produit à forte variation chromatique.

Produkt mit starker farbnuance.

Producto con fuerte variación cromática.

# Superfici Florim

SURFACES/SURFACES/OBERFLÄCHEN/SUPERFICIES

## Finitura MATT/OPACA

La superficie Naturale si caratterizza per un effetto tipicamente Matt/opaco. Può essere liscia o leggermente strutturata. Questo effetto si ottiene tramite la pressatura del materiale senza ulteriori lavorazioni dopo la cottura. Le varianti di questa superficie includono **Naturale, Matte e Sablé**.

## Finitura STRUTTURATA

Caratterizzata da una evidente struttura superficiale può essere divisa in due categorie: La superficie Strutturata è concepita per ottenere precise caratteristiche estetiche, con profondità variabili e un effetto estetico tridimensionale. Questo tipo di superficie nasce dalla pressatura con un tampone non liscio e non subisce lavorazioni successive alla cottura. Tra le varianti troviamo **Strutturato, Cannetté e Bocciardato**.

La superficie Grip è finalizzata a raggiungere precise caratteristiche di sicurezza antiscivolo, adattandosi alla destinazione d'uso. Questa superficie viene ottenuta tramite la pressatura con un tampone sagomato, senza ulteriori lavorazioni dopo la cottura. Le varianti includono **Grip, Comfort e R + PTV**.

## Finitura SEMI GLOSSY/LUCIDA

Caratterizzata da un effetto superficiale semi-lucido, Può essere liscia o leggermente strutturata ed è divisa in due categorie: La superficie Spazzolata presenta un effetto morbido, leggermente satinato e non riflettente, risultando più opaca rispetto alla superficie Lappata. Questa superficie viene realizzata attraverso una lavorazione meccanica di intensità intermedia dopo la cottura, a partire da una superficie pressata. Le varianti possibili sono **Spazzolato, Soft e Matte Silk**.

La superficie Lappata si distingue per essere un po' più lucida rispetto alla superficie Spazzolata, mantenendo comunque un effetto morbido, lievemente satinato e non riflettente. Si ottiene tramite una lavorazione meccanica di intensità intermedia dopo la cottura, utilizzando un tampone liscio o ondulato. Tra le varianti troviamo **Lappato, Smooth/Satin, Patiné/Adouci e Matte Leather**.

## Finitura GLOSSY/LUCIDA

La superficie Glossy è caratterizzata da un effetto lucido e riflettente. Può essere liscia o leggermente strutturata. Questo risultato si ottiene mediante spazzolata e lucidatura meccanica con abrasione decrescente dopo la cottura, utilizzando esclusivamente un tampone liscio. Le varianti disponibili per questa superficie includono **Glossy, High Glossy e Glossy Bright**.

### MATT/OPAQUE Finish

The Natural surface is characterized by a typically matt/opaque effect. It can be smooth or slightly textured. This effect is achieved by pressing the material without further processing after firing. Variations of this surface include **Natural, Matte, and Sablé**.

### TEXTURED Finish

Characterized by a pronounced surface texture, it can be divided into two categories: The Textured surface is designed to achieve specific aesthetic characteristics, with varying depths and a three-dimensional visual effect. This surface type is created by pressing with a non-smooth mold and does not undergo further processing after firing. Variants include **Textured, Ribbed, and Bush-Hammered**.

The Grip surface is intended to achieve specific anti-slip safety characteristics, suitable for its intended use. This surface is obtained by pressing with a shaped mold, without further processing after firing. Variants include **Grip, Comfort, and R + PTV**.

### SEMI-GLOSSY Finish

Characterized by a semi-glossy surface effect, it can be smooth or slightly textured and is divided into two categories: The Brushed surface has a soft, slightly satin, and non-reflective effect, making it less glossy compared to the Polished surface. This finish is achieved through an intermediate mechanical process after firing, starting from a pressed surface. Possible variants include **Brushed, Soft, and Matte Silk**.

The Lappato surface stands out as slightly glossier than the Brushed surface while maintaining a soft, slightly satin, and non-reflective effect. It is achieved through medium-intensity mechanical processing after firing, using a smooth or wavy mold. Variants include **Lappato, Smooth/Satin, Patiné/Adouci and Matte Leather**.

### GLOSSY Finish

The Glossy surface is characterized by a shiny and reflective effect. It can be smooth or slightly textured. This result is obtained through brushing and mechanical polishing with decreasing abrasion after firing, using exclusively a smooth pad. Available variants for this surface include **Glossy, High Glossy, and Glossy Bright**.

## Finitura MATT/OPAQUE

La surface Naturelle se caractérise par un effet typiquement mat/opaque. Elle peut être lisse ou légèrement structurée. Cet effet est obtenu par pressage du matériau sans autres traitements après cuisson. Les variantes de cette surface incluent **Naturelle, Mat et Sablé**.

## Finition STRUCTURÉE

Caractérisée par une texture de surface évidente, elle peut être divisée en deux catégories : La surface Structurée est conçue pour obtenir des caractéristiques esthétiques spécifiques, avec des profondeurs variables et un effet visuel tridimensionnel. Ce type de surface est créé par pressage avec un tampon non lisse et ne subit pas de traitements supplémentaires après cuisson. Les variantes incluent **Structuré, Canneté et Bouchardé**.

La surface Grip est conçue pour atteindre des caractéristiques de sécurité antidérapante spécifiques, adaptée à son usage. Cette surface est obtenue par pressage avec un tampon façonné, sans traitement supplémentaire après cuisson. Les variantes incluent **Grip, Comfort et R + PTV**.

## Finition SEMI-GLOSSY

Caractérisée par un effet de surface semi-brillant, elle peut être lisse ou légèrement texturée et est divisée en deux catégories : La surface Brossée présente un effet doux, légèrement satiné et non réfléchissant, ce qui la rend moins brillante que la surface Polie. Cette finition est réalisée grâce à un processus mécanique intermédiaire après la cuisson, à partir d'une surface pressée. Les variantes possibles incluent **Brossé, Soft et Matte Silk**.

La surface Lappato se distingue par un effet légèrement plus brillant que la surface Brossée, tout en maintenant un rendu doux, légèrement satiné et non réfléchissant. Elle est obtenue par un traitement mécanique d'intensité moyenne après cuisson, en utilisant un tampon lisse ou ondulé. Les variantes incluent Lappato, **Lisse/Satiné, Patiné/Adouci et Cuir Mat**.

## Finition GLOSSY

La surface Brillante se caractérise par un effet brillant et réfléchissant. Elle peut être lisse ou légèrement texturée. Ce résultat est obtenu grâce au brossage et au polissage mécanique avec une abrasion décroissante après la cuisson, en utilisant exclusivement un tampon lisse. Les variantes disponibles pour cette surface incluent **Brillant, High Glossy et Glossy Bright**.

## MATT/OPAQUE Finish

Die Natur-Oberfläche zeichnet sich durch eine typische Matt/undurchsichtige Optik aus. Sie kann glatt oder leicht strukturiert sein. Dieser Effekt wird durch das Pressen des Materials ohne weitere Bearbeitung nach dem Brennen erzielt.

Varianten dieser Oberfläche umfassen **Natur, Matt** und **Sablé**.

## STRUKTURIERTE Oberfläche

Gekennzeichnet durch eine ausgeprägte Oberflächenstruktur, kann sie in zwei Kategorien unterteilt werden:

Die strukturierte Oberfläche ist so konzipiert, dass sie spezifische ästhetische Eigenschaften mit variierender Tiefe und einem dreidimensionalen ästhetischen Effekt erzielt. Dieser Oberflächentyp entsteht durch das Pressen mit einem nicht glatten Stempel und wird nach dem Brennen nicht weiter bearbeitet.

Varianten sind **Strukturiert, Gerippt** und **Bushammer**.

Die Grip-Oberfläche ist darauf ausgelegt, spezifische rutschfeste Sicherheitseigenschaften zu erzielen, die auf den Verwendungszweck abgestimmt sind. Diese Oberfläche wird durch Pressen mit einem geformten Stempel erreicht, ohne weitere Bearbeitung nach dem Brennen.

Varianten umfassen **Grip, Komfort** und **R + PTV**.

## SEMI-GLOSSY Finish

Gekennzeichnet durch einen halbgänzenden Oberflächeneffekt, kann sie glatt oder leicht strukturiert sein und wird in zwei Kategorien unterteilt:

Die Gebürstete Oberfläche hat einen weichen, leicht satinierten und nicht reflektierenden Effekt, wodurch sie weniger glänzend ist als die Polierte Oberfläche.

Diese Oberfläche wird durch einen mittleren mechanischen Prozess nach dem Brennen erzielt, beginnend mit einer gepressten Oberfläche.

Mögliche Varianten sind **Gebürstet, Soft** und **Matte Silk**.

Die Lappato-Oberfläche ist etwas glänzender als die gebürstete Oberfläche, behält jedoch eine weiche, leicht satinierte und nicht reflektierende Wirkung bei.

Sie wird durch eine mittelintensive mechanische Bearbeitung nach dem Brennen unter Verwendung eines glatten oder welligen Stempels erzielt.

Varianten umfassen **Lappato, Smooth/Satin** und **Patiné/Ádouci Matte Leather**.

## GLÄNZENDE Oberfläche

Die glänzende Oberfläche zeichnet sich durch einen glänzenden und reflektierenden Effekt aus. Sie kann glatt oder leicht strukturiert sein.

Dieses Ergebnis wird durch Bürsten und mechanisches Polieren mit abnehmender Abrasion nach dem Brennen erzielt, wobei ausschließlich ein glattes Polierpad verwendet wird.

Verfügbare Varianten für diese Oberfläche sind **Glossy, High Glossy** und **Glossy Bright**.

## Acabado MATE/OPACO

La superficie Natural se caracteriza por un efecto típicamente mate/opaco. Puede ser lisa o ligeramente texturizada.

Este efecto se obtiene mediante la prensado del material sin más procesos después de la cocción.

Las variantes de esta superficie incluyen **Natural, Mate** y **Sablé**.

## Acabado ESTRUCTURADO

Caracterizado por una estructura superficial pronunciada, se puede dividir en dos categorías:

La superficie Estructurada está diseñada para lograr características estéticas específicas, con profundidades variables y un efecto visual tridimensional.

Este tipo de superficie se crea mediante prensado con un molde no liso y no se somete a más procesos después de la cocción.

Las variantes incluyen **Estructurado, Canalado** y **Abujardado**.

La superficie Grip está diseñada para cumplir características antideslizantes específicas, adecuadas para su uso.

Esta superficie se obtiene mediante prensado con un molde conformado, sin procesamientos adicionales después de la cocción.

Las variantes incluyen **Grip, Comfort** y **R + PTV**.

## Acabado SEMI-BRILLANTE

Caracterizado por un efecto superficial semi-brillante, puede ser liso o ligeramente texturizado y se divide en dos categorías:

La superficie Cepillada presenta un efecto suave, ligeramente satinado y no reflectante, siendo menos brillante que la superficie Pulida.

Este acabado se logra mediante un proceso mecánico intermedio después de la cocción, partiendo de una superficie prensada.

Las variantes posibles son **Cepillado, Soft** y **Matte Silk**.

La superficie Lappato se caracteriza por ser un poco más brillante que la superficie Cepillada, manteniendo un efecto suave, ligeramente satinado y no reflectante.

Se obtiene mediante un proceso mecánico de intensidad media después de la cocción, utilizando un molde liso u ondulado.

Las variantes incluyen **Lappato, Suave/Satén, Patinado/Ádouci** y **Cuero Mate**.

## Acabado BRILLANTE

La superficie Brillante se caracteriza por un efecto brillante y reflectante. Puede ser lisa o ligeramente texturizada.

Este resultado se obtiene mediante cepillado y pulido mecánico con abrasión decreciente después de la cocción, utilizando exclusivamente un tampón liso.

Las variantes disponibles para esta superficie incluyen **Glossy, High Glossy** y **Glossy Bright**.

# Tabella Imballi

PACKAGE TABLE - TABLEAU DE EMBALLAGES - TABELLE FORMATE - TABLA DE LOS EMBALAJES

|  | scatola - box |    |    | pallet |    |    |
|--|---------------|----|----|--------|----|----|
|  | pz            | mq | kg | box    | mq | kg |
|  |               |    |    |        |    |    |
|  |               |    |    |        |    |    |
|  |               |    |    |        |    |    |
|  |               |    |    |        |    |    |
|  |               |    |    |        |    |    |
|  |               |    |    |        |    |    |

**imballi per scatola**  
packages for boxes  
emballages pour boîte  
verpackungen für schachteln  
embalajes para cajas

**imballi per pallet**  
packages for pallets  
emballages pour palette  
verpackungen für paletts  
embalajes para paletas







# BIOTECH

gres fine porcellanato  
fine porcelain stoneware  
grès cérame fin  
feinsteinzeug-kollektionen  
gres porcelánico fino





Questa collezione fa parte del progetto CarbonZero, le superfici Carbon Neutral che compensano tutta la CO<sub>2</sub> emessa durante il loro ciclo di vita.

*This collection is part of CarbonZero project, Florim's Carbon Neutral surfaces offset all the CO<sub>2</sub> emitted during their lifecycle.*



## BIOTECH / ELITE

**Biotech** è la collezione di Florim che incontra i principi della Bioarchitettura. Destinata ai progetti architettonici, propone una selezione di pietre industriali in grande formato realizzate attraverso tecnologie innovative che permettono di spingersi oltre la consueta efficienza produttiva che Florim assicura nelle sue Fabbriche 4.0, con alti standard qualitativi in termini di performance tecniche ed estetiche. Un corpo tutta massa e superfici materiche che richiamano le pietre di ispirazione costituiscono il tratto distintivo di Biotech, realizzata utilizzando materie prime certificate e nuovi impianti capaci di decorare riducendo il consumo d'acqua, di energia e di emissioni nell'aria.

The **Biotech** collection by Florim embraces the principles of sustainable architecture. Devised for architecture projects, it contains a selection of industrial stones with large formats. They have been produced using innovative technologies that take things to an even higher level than the customary production efficiency found in Florim's Industry 4.0 factories, with high standards of technical and aesthetic performance. Biotech's distinguishing features are full bodies and surfaces whose material properties call to mind the stones that inspired them. The products are made using certified raw materials and new decorative systems with lower water consumption, energy consumption and emissions.

**Biotech** est la collection de Florim qui épouse les principes de la bio-architecture. Destinée aux projets architecturaux, elle propose une sélection de pierres industrielles grand format réalisées grâce à des technologies innovantes qui permettent de dépasser l'efficacité de production que Florim garantit habituellement dans ses Usines 4.0, avec des normes de qualité élevées en termes de performances techniques et esthétiques. Corps pleine masse et surfaces matérielles rappelant les pierres d'inspiration : telles sont les caractéristiques de Biotech, réalisée à partir de matières premières certifiées et avec de nouveaux équipements capables de réaliser des décors en réduisant la consommation d'eau, d'énergie et les émissions atmosphériques.

**Biotech** ist die Kollektion von Florim, die sich an den Prinzipien der Bio-Architektur orientiert. Sie ist für architektonische Projekte bestimmt und bietet eine Auswahl an großformatigem Kunststein, der mit innovativen Technologien hergestellt wird. Dadurch ist es möglich, über die übliche Produktionseffizienz hinauszugehen, die Florim in seinen 4.0 Produktionsstätten mit hohen Qualitätsstandards in Bezug auf technische und ästhetische Leistungen gewährleistet. Ein massiver Korpus und strukturierte, an Naturstein erinnernde Oberflächen sind das Markenzeichen von Biotech, das aus zertifizierten Rohstoffen und unter Verwendung hochmoderner Anlagen hergestellt wird. Diese ermöglichen hochwertige Einrichtungslösungen unter Reduzierung des Wasser- und Energieverbrauchs sowie der Luftemissionen.

**Biotech** es la colección de Florim inspirada en los principios de la bioarquitectura. Destinada a proyectos arquitectónicos, ofrece una selección de piedras industriales de gran formato realizadas con tecnologías innovadoras que permiten ir más allá de la habitual eficiencia productiva que Florim garantiza en sus Fábricas 4.0, con altos estándares de calidad en cuanto a prestaciones técnicas y estéticas. Un cuerpo todo masa y superficies matéricas que recuerdan las piedras de inspiración son el rasgo distintivo de Biotech, creada con materias primas certificadas y nuevos sistemas de decoración que reducen al mismo tiempo el consumo de agua, energía y emisiones contaminantes.

# BIOTECH / ELITE

## CREMA STONE



## STONEWOOD



**R10**  
**CLASSE B**  
(naturele)

**R10**  
(canneté)

**R11**  
(R+PTV)

DCOF>  
0,42 Wet

BS EN 16165  
ANNEX C  
>36 Wet  
slider 96  
(R+PTV)

9 mm 3/8" ↑↓



**R9**  
(soft)

**R10**  
**CLASSE B**  
(naturele)

6 mm 1/4" ↑↓

FLOORM OVERSIZE  
magnum

### GRES FINE PORCELLANATO

FINE PORCELAIN STONEWARE / GRÈS CÉRAME FIN / FEINSTEINZEUG-KOLLEKTIONEN / GRES PORCELÁNICO FINO

SQUADRATO - SQUARED - EQUARRI - REKTIFIZIERT - ESCUADRADO

| 9 mm 3/8" ↑↓   | COLOR       | SURFACE        | 120x120<br>47 1/4" x 47 1/4" | 80x180<br>31 1/2" x 70 5/8" | 80x80<br>31 1/2" x 31 1/2" | 60x120<br>23 5/8" x 47 1/4" | 60x60<br>23 5/8" x 23 5/8" | 30x60<br>11 4/5" x 23 5/8" |
|----------------|-------------|----------------|------------------------------|-----------------------------|----------------------------|-----------------------------|----------------------------|----------------------------|
| <b>BIOTECH</b> | CREMA STONE | NATURALE/MATTE | -                            | 778856                      | 780889                     | 778861                      | 779221                     | 779500                     |
|                |             | R+PTV          | 779557                       | -                           | -                          | 779560                      | -                          | -                          |
|                |             | CANNETÉ        | -                            | -                           | -                          | 778865                      | -                          | -                          |
|                | STONEWOOD   | NATURALE/MATTE | -                            | 778858                      | -                          | 778863                      | 779223                     | 779502                     |
|                |             | R+PTV          | 779558                       | -                           | -                          | 779561                      | -                          | -                          |
|                |             | CANNETÉ        | -                            | -                           | -                          | 778867                      | -                          | -                          |

| 6 mm 1/4" ↑↓   | COLOR       | SURFACE        | 120x280<br>47 1/4" x 110 1/4" | 120x240<br>47 1/4" x 94 1/2" | 120x120<br>47 1/4" x 47 1/4" | 60x120<br>23 5/8" x 47 1/4" |
|----------------|-------------|----------------|-------------------------------|------------------------------|------------------------------|-----------------------------|
| <b>BIOTECH</b> | CREMA STONE | NATURALE/MATTE | 778773                        | 778786                       | 778793                       | 778798                      |
|                |             | SOFT           | 779015                        | 779019                       | 779022                       | 779025                      |
|                | STONEWOOD   | NATURALE/MATTE | 779016                        | 779020                       | 779023                       | 779026                      |
|                |             | SOFT           | 778777                        | 778791                       | 778796                       | 778801                      |



## LAPIS GREIGE



## SERIZZO STONE



**R10**  
**CLASSE B**  
(naturale)

**R10**  
(canneté)

**R11**  
(R+PTV)

DCOF >  
0,42 Wet

BS EN 16165  
ANNEX C  
>36 Wet  
slider 96  
(R+PTV)

9 mm 3/8" ↑↓

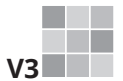



**R9**  
(soft)



**R10**  
**CLASSE B**  
(naturale)

6 mm 1/4" ↑↓

FLORIM OVERSIZE  
**magnUm**

**GRES FINE PORCELLANATO**  
FINE PORCELAIN STONEWARE / GRÈS CÉRAME FIN / FEINSTEINZEUG-KOLLEKTIONEN / GRES PORCELÁNICO FINO  
SQUADRATO - SQUARED - EQUARRI - REKTIFIZIERT - ESCUADRADO

| 9 mm 3/8" ↑↓  | COLOR         | SURFACE        | 120x120<br>47 <sup>1/4"</sup> x47 <sup>1/4"</sup> | 80x180<br>31 <sup>1/2"</sup> x70 <sup>5/7"</sup> | 80x80<br>31 <sup>1/2"</sup> x31 <sup>1/2"</sup> | 60x120<br>23 <sup>5/8"</sup> x47 <sup>1/4"</sup> | 60x60<br>23 <sup>5/8"</sup> x23 <sup>5/8"</sup> | 30x60<br>11 <sup>4/5"</sup> x23 <sup>5/8"</sup> |
|---|---------------|----------------|---|--|---|--|---|---|
|  | LAPIS GREIGE  | NATURALE/MATTE | -   | 778857   | 780890  | 778862   | 779222  | 779501  |
|   |               | R+PTV          | 779556  | -  | -   | 779559   | -   | -   |
|   |               | CANNETÉ        | -   | -  | -   | 778866   | -   | -   |
| <b>BIOTECH</b>  |               |                |   |  |   |  |   |   |
|  | SERIZZO STONE | NATURALE/MATTE | -   | 778855   | -   | 778860   | 779220  | 779499  |

| 6 mm 1/4" ↑↓  | COLOR         | SURFACE        | 120x280<br>47 <sup>1/4"</sup> x110 <sup>1/4"</sup> | 120x240<br>47 <sup>1/4"</sup> x94 <sup>1/2"</sup> | 120x120<br>47 <sup>1/4"</sup> x47 <sup>1/4"</sup> | 60x120<br>23 <sup>5/8"</sup> x47 <sup>1/4"</sup> |
|---|---------------|----------------|--|---|---|--|
|  | LAPIS GREIGE  | NATURALE/MATTE | 778774   | 778789  | 778794  | 778799   |
|   |               | SOFT           | 779014   | 779018  | 779021  | 779024   |
| <b>BIOTECH</b>  |               |                |  |   |   |  |
|  | SERIZZO STONE | NATURALE/MATTE | 778772   | 778782  | 778792  | 778797   |

# BIOTECH / ELITE

## SOAP STONE



V2

R9  
(soft)

DCOF >  
0,42 Wet

9 mm 3/8" ↑↓



V2

R9  
(soft)

6 mm 1/4" ↑↓

FLOIRIM OVERSIZE  
magnum

**GRES FINE PORCELLANATO**  
FINE PORCELAIN STONEWARE / GRÈS CÉRAMÉ FIN / FEINSTEINZEUG-KOLLEKTIONEN / GRES PORCELÁNICO FINO  
SQUADRATO - SQUARED - EQUARRI - REKTIFIZIERT - ESCUADRADO

| 9 mm 3/8" ↑↓   | COLOR | SURFACE    | 80x180<br>31 1/2" x 70 5/7" | 60x120<br>23 5/8" x 47 1/4" | 60x60<br>23 5/8" x 23 5/8" | 30x60<br>11 1/5" x 23 5/8" |        |
|----------------|-------|------------|-----------------------------|-----------------------------|----------------------------|----------------------------|--------|
| <b>BIOTECH</b> |       | SOAP STONE | SOFT                        | 778859                      | 778864                     | 779224                     | 779503 |



| 6 mm 1/4" ↑↓   | COLOR | SURFACE    | 120x280<br>47 3/4" x 110 1/4" | 120x240<br>47 3/4" x 94 1/2" | 120x120<br>47 1/4" x 47 1/4" | 60x120<br>23 5/8" x 47 1/4" |        |
|----------------|-------|------------|-------------------------------|------------------------------|------------------------------|-----------------------------|--------|
| <b>BIOTECH</b> |       | SOAP STONE | SOFT                          | 778775                       | 778790                       | 778795                      | 778800 |

## GRES FINE PORCELLANATO

FINE PORCELAIN STONEWARE / GRÈS CÉRAME FIN / FEINSTEINZEUG-KOLLEKTIONEN / GRES PORCELÁNICO FINO  
 SQUADRATO - SQUARED - EQUARRI - REKTIFIZIERT - ESCUADRADO

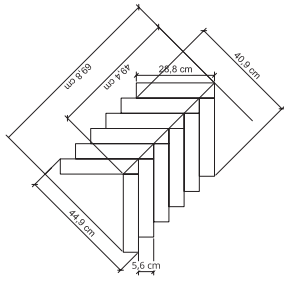

| 9 mm 3/8" ↑↓   |   | COLOR              | SURFACE              | 29x38<br>11 <sup>3/7"</sup> x15"<br>pz/box 6 |
|----------------|---|--------------------|----------------------|--|
| <b>BIOTECH</b> |  | TOUCH CREMA STONE  | MIX<br>MATTE/CANNETÉ | 779353                                       |
|                |   | TOUCH STONEWOOD    | MIX<br>MATTE/CANNETÉ | 779354                                       |
|                |   | TOUCH LAPIS GREIGE | MIX<br>MATTE/CANNETÉ | 779355                                       |

| 9 mm 3/8" ↑↓ |  | COLOR | SURFACE |  |
|--------------|--|-------|---------|--|
| HERRINGBONE  |  |       |         |  |

|                |   |              |       |        |
|----------------|---|--------------|-------|--------|
| <b>BIOTECH</b> |   | CREMA STONE  | MATTE | 779361 |
|                |  | STONEWOOD    | MATTE | 779362 |
|                |  | LAPIS GREIGE | MATTE | 779363 |

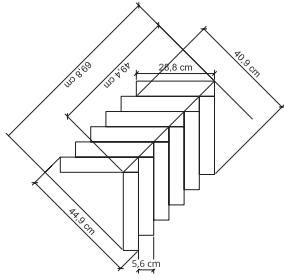







| 6 mm 1/4" ↑↓   |   | COLOR                    | SURFACE        | 33,5x37<br>13 <sup>1/5"</sup> x14 <sup>4/7"</sup><br>pz/box 6 |
|----------------|---|--------------------------|----------------|---|
| <b>BIOTECH</b> |  | SQUARES<br>SERIZZO STONE | NATURALE/MATTE | 779356  |
|                |   | SQUARES<br>SOAP STONE    | SOFT           | 779357  |

| 6 mm 1/4" ↑↓ |  | COLOR | SURFACE |  |
|--------------|--|-------|---------|--|
| HERRINGBONE  |  |       |         |  |

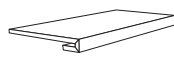
|                |   |              |       |        |
|----------------|---|--------------|-------|--------|
| <b>BIOTECH</b> |  | CREMA STONE  | MATTE | 779358 |
|                |  | STONEWOOD    | MATTE | 779359 |
|                |  | LAPIS GREIGE | MATTE | 779360 |

# BIOTECH / ELITE

PEZZI SPECIALI/SPECIAL TRIMS/PIÈCES SPÉCIALES/FORMSTÜCKE/PIEZAS ESPECIALES

| 9 mm 3/8"  | COLOR         | SURFACE  | 4,6x120<br>1 4/5"x4 7/8"   | 33x120x3<br>13"x4 7/8"x1 1/8"  |
|---|---------------|----------|--|--|
|   |               |          | battiscopa  | gradino<br>pz/box 2  |
|            | CREMA STONE   | NATURALE | 779580   | 779032   |
|            | STONEWOOD     | NATURALE | 779584   | 779036   |
|            | LAPIS GREIGE  | NATURALE | 779581   | 779033   |
|            | SERIZZO STONE | NATURALE | 779582   | 779034   |
|            | SOAP STONE    | SOFT     | 779583   | 779035   |

BIOTECH

FLORIM OVERSIZE  
**magnUm**

**120x280/120x240/120x120/60x120**  
 Specifica Imballo pag.  
 Packaging specifications on page  
 Spécifications d'emballage à page  
 Verpackungsdetail Seite  
 Especificaciones de embalaje a la página  
**162/163**

| BIOTECH     | scatola - box |      |       | pallet |       |      |
|-------------|---------------|------|-------|--------|-------|------|
|             | pz            | mq   | kg    | box    | mq    | kg   |
| 120x120     | 2             | 2,88 | 63,07 | 20     | 57,60 | 1340 |
| 80x180      | 2             | 2,88 | 59,33 | 20     | 57,60 | 1240 |
| 60x120      | 2             | 1,44 | 28,44 | 30     | 43,20 | 880  |
| 80x80       | 2             | 1,28 | 25,28 | 40     | 51,20 | 1040 |
| 60x60       | 3             | 1,08 | 21,33 | 40     | 43,20 | 880  |
| 30x60       | 6             | 1,08 | 21,33 | 40     | 43,20 | 880  |
| HERRINGBONE | 6             | 1,21 | 17,52 | 16     | 19,36 | 310  |

| BIOTECH            | scatola - box |      |      | pallet |    |    |
|--------------------|---------------|------|------|--------|----|----|
|                    | pz            | ml   | kg   | box    | mq | kg |
| 4,6x120 battiscopa | 6             | 7,20 | 7,20 | -      | -  | -  |

Per un effetto ottimale della posa, Florim suggerisce di mantenere 2 mm di fuga per pose monoformato e 3 mm per combinare formati misti - For optimal installation results, Florim recommends maintaining a joint of 2 mm 1/12" for single format installations and 3 mm 1/8" to combine mixed formats. - Pour réaliser une pose parfait, Florim conseille de laisser 2 mm de joint pour la pose des monoformats et 3 mm pour les combinaisons de formats mixtes. - Um einen optimalen effekt beim verlegen zu erzielen empfiehlt Florim eine 2 mm fugе bei einformatigen verlegungen und 3 mm fugе bei formatkombinationen - Para lograr los máximos resultados en la posa del producto, Florim aconseja 2 mm de junta en aplicaciones monoformato y 3 mm en combinaciones de formatos mixtos.





# BIOTECH OUTDOOR / ELITE

## Vantaggi tecnici - Technical advantages - Avantages techniques Technische Vorteile - Ventajas técnicas

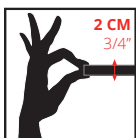

- Lastra monolitica compatta di spessore 2 cm squadrata e rettificata
- Compact monolithic slab 2 cm thick squared and rectified
- Dalle monolithique compacte de 2 cm d'épaisseur, équerrie et rectifiée
- Kompakte monolithische Platte, 2 cm dick, rechteckig und scharfkantig geschliffen
- Losa monolítica compacta de 2 cm de espesor, escuadrada y rectificada.

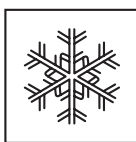

- INGELIVO
- FROST RESISTANT
- INGÉLIF
- FROSTBESTÄNDIG
- RESISTENTE A LA HELADA



- ELEVATA RESISTENZA AI CARICHI STATICI
- HIGH STATIC LOAD RESISTANCE
- RÉSISTANCE ÉLEVÉE AUX CHARGES STATIQUES
- HOHE STATISCHE BELASTBARKEIT
- ELEVADA RESISTENCIA A LAS CARGAS ESTÁTICAS



- FACILE DA POSARE
- EASY TO INSTALL
- FACILE À POSER
- VERLEGELEICHT
- FÁCIL DE COLOCAR



- ANTISCIVOLO R11
- ANTI SLIP R11
- ANTIDÉRAPANT R11
- RUTSCHFEST R11
- ANTIDESLIZANTE R11

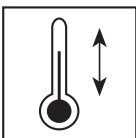

- RESISTENTE AGLI SBALZI TERMICI
- THERMAL SHOCK RESISTANT
- RÉSISTANT AUX ÉCARTS THERMIQUES
- TEMPERATURWECHSELBESTÄNDIG
- RESISTENTE A LAS OSCILACIONES TÉRMICAS



- FACILE DA PULIRE
- EASY TO CLEAN
- FACILE À NETTOYER
- REINIGUNGSLEICHT
- FÁCIL DE LIMPIAR

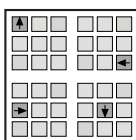

- RIMOVIBILE E RIUTILIZZABILE
- REMOVABLE AND REUSABLE
- DÉMONTABLE ET RÉUTILISABLE
- ENTFERNBAR UND WIEDERVERWENDBAR
- DESMONTABLE Y REUTILIZABLE



- INATTACCABILE DA AGENTI CHIMICI E MUFFE
- IMPERVIUS TO ATTACK BY CHEMICALS OR MOULD
- RÉSISTANT AUX AGENTS CHIMIQUES ET AUX MOISSISSURES
- UNANGREIFBAR DURCH CHEMISCHE STOFFE UND SCHIMMEL
- RESISTENTE A LOS AGENTES QUÍMICOS Y A LOS MOHOS

## Applicazioni - Applications - Applications - Verlegung - Aplicaciones

- Posa diretta su erba
- Direct installation on grass
- Pose directe sur de l'herbe
- Verlegung direkt auf Rasen
- Colocación directa sobre hierba

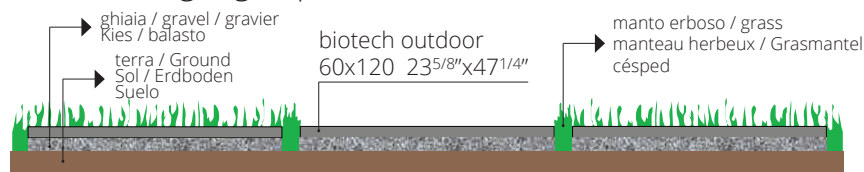

- Posa diretta su ghiaia
- Direct installation over gravel
- Pose direct sur du gravier
- Verlegung direkt auf Kies
- Colocación directa sobre grava



- Posa su massetto cementizio
- Installation on sand-cement screed
- Pose sur chape ciment
- Verlegung auf Zement-Unterbetonblock
- Colocación sobre contrapiso de hormigón

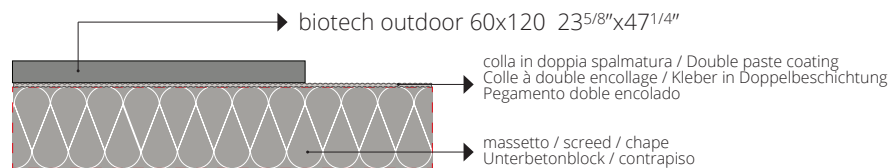

- Posa su piedini fissi o regolabili
- Installation on fixed or adjustable feet
- Pose sur pieds fixes ou réglables
- Verlegung auf feststehende oder regulierbare Füße
- Colocación sobre pies fijos o regulables

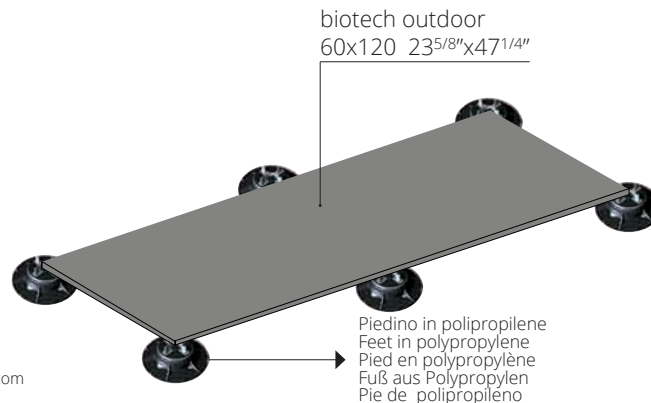

Per le specifiche di utilizzo dei sistemi sopraelevati vedi il sito florim.com  
For the specifics on use of raised systems visit the site florim.com  
Pour les caractéristiques d'utilisation des systèmes surélevés, voir le site florim.com  
Für die Nutzungsbedingungen der Doppelbodensysteme siehe Webseite florim.com  
Para las especificaciones de empleo de los sistemas sobreelevados consulte el sitio web florim.com

Le lastre ceramiche sono sottoposte a un trattamento di compattazione termica che assicura resistenza e durata nel tempo. Il bassissimo assorbimento d'acqua rende perciò il materiale ingelivo. Ciò può comportare ristagni d'acqua superficiali anche per materiale installato a regola d'arte. / Ceramic tiles undergo a compacting thermal treatment that ensures resistance and durability. The low level of water absorption makes the slabs frost resistant. This could result in superficial water stagnations even if materials are installed in a workmanlike manner. / Les carreaux de céramique subissent un traitement thermique de compactage qui assure résistance et durabilité. Le faible niveau d'absorption d'eau rend les dalles résistantes au gel. Il pourrait en résulter des stagnations d'eau superficielles, même si les dalles ont été installées dans les règles de l'art. / Die Keramikplatten werden einer thermischen Verdichtung unterzogen, welche die Widerstandsfähigkeit und Langlebigkeit sichert. Die extrem niedrige Wasseraufnahme macht das Material frostsicher. Die hohe Materialdichte kann, auch bei einer perfekten Verlegung, eine längere Abtrochnungszeit von angestaumtem Wasser zur Folge haben. / Las baldosas cerámicas se someten a un tratamiento de compactación térmica que asegura resistencia y durabilidad. La baja absorción de agua hace que las baldosas resistan al hielo. Esto podría resultar en estancamientos superficiales de agua, incluso si los materiales están instalados según las reglas del arte.

## CREMA STONE



## STONEWOOD



**V2**  
CREMA STONE  
SOAP STONE

**V3**  
STONEWOOD  
LAPIS GREIGE  
SERIZZO STONE

**R11**  
**CLASSE C**  
(strutturato)

DCOF>  
0,42 Wet

20 mm 3/4" ↑↓

## LAPIS GREIGE



## SERIZZO STONE

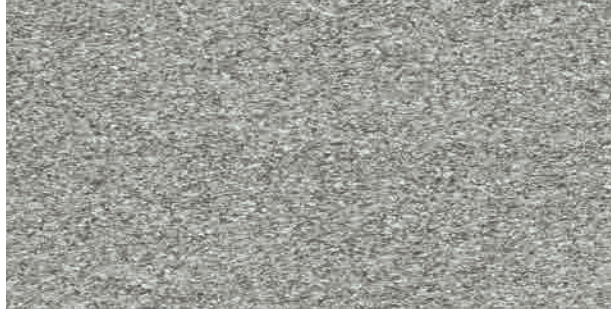



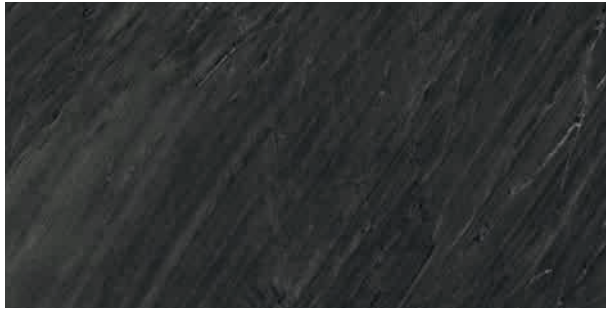

## SOAP STONE



### GRES FINE PORCELLANATO

FINE PORCELAIN STONEWARE/GRES CERAME FIN/FEINSTEINZEUG-KOLLEKTIONEN/GRES PORCELANICO FINO  
SQUADRATO - SQUARED - EQUARRI - REKTIFIZIERT - ESCUADRADO

20 mm 3/4" ↑↓

|   | COLOR         | SURFACE     | 60x120<br>23 <sup>5</sup> / <sub>8</sub> "x47 <sup>1</sup> / <sub>4</sub> " | 120x120<br>47 <sup>1</sup> / <sub>4</sub> "x47 <sup>1</sup> / <sub>4</sub> " |
|---|---------------|-------------|---|--|
|                    | CREMA STONE   | STRUTTURATO | 776402  | 782487   |
|                    | STONEWOOD     | STRUTTURATO | 776405  | -  |
| <b>BIOTECH</b><br> | LAPIS GREIGE  | STRUTTURATO | 776403  | 782489   |
|                    | SERIZZO STONE | STRUTTURATO | 776400  | -  |
|                    | SOAP STONE    | STRUTTURATO | 776406  | -  |

### PEZZI SPECIALI

Special trims/Pièces spéciales/Formstücke  
Piezas especiales  
pag 152/155

|   |  |   |
|---|--|---|
|  | <b>RESISTENZA ALLA FLESSIONE IN N/mm<sup>2</sup></b><br>N/mm <sup>2</sup> FLEXURAL STRENGTH TEST / RESISTANCE<br>A LA FLEXION EN N/mm <sup>2</sup> / BIEGEFESTIGKEIT IN<br>N/mm <sup>2</sup> / RESISTENCIA A LA FLEXION EN N/mm <sup>2</sup> | <b>valore medio</b><br><b>52 N/mm<sup>2</sup></b> |
|   | <b>Forza di rottura in N (sp. &gt; 7,5 mm)</b><br>Breaking strength in N (sp. > 7,5 mm) / Force de<br>rupture en N (sp. > 7,5 mm) / Bruchlast in N (Dicke ><br>7,5 mm) / Fuerza de rotura en N (gr. > 7,5 mm)                                | <b>valore medio</b><br><b>14000 N</b>             |

| BIOTECH      | scatola - box |      |       | pallet |       |      |
|--------------|---------------|------|-------|--------|-------|------|
|              | pz            | mq   | kg    | box    | mq    | kg   |
| 60x120 20mm  | 1             | 0,72 | 32,04 | 30     | 21,60 | 990  |
| 120x120 20mm | 1             | 1,44 | 66,96 | 20     | 28,80 | 1400 |

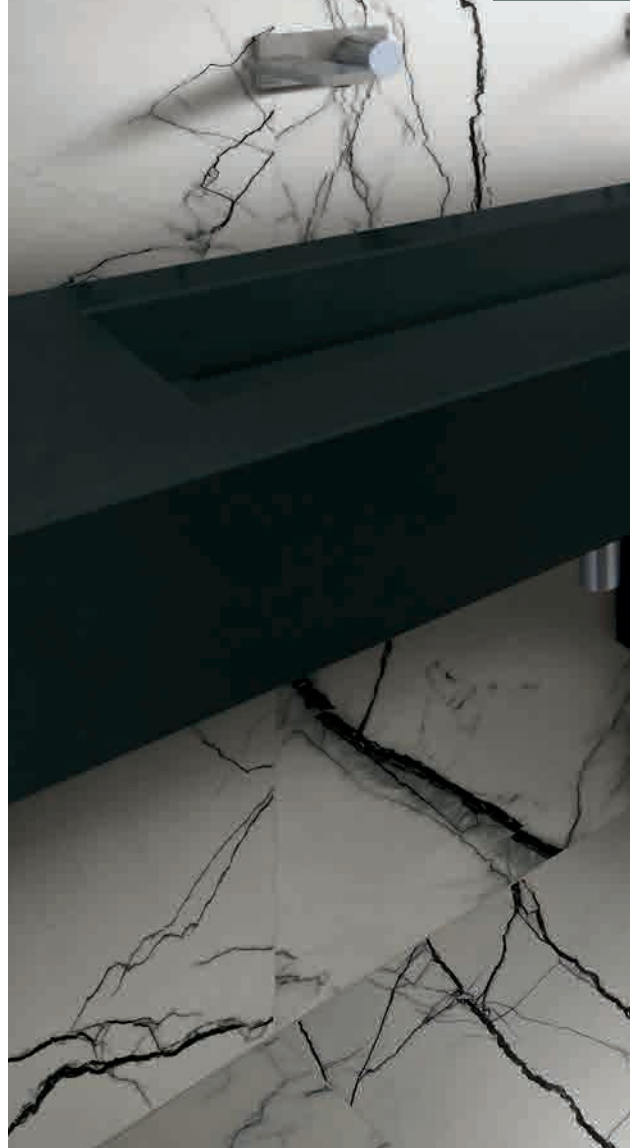
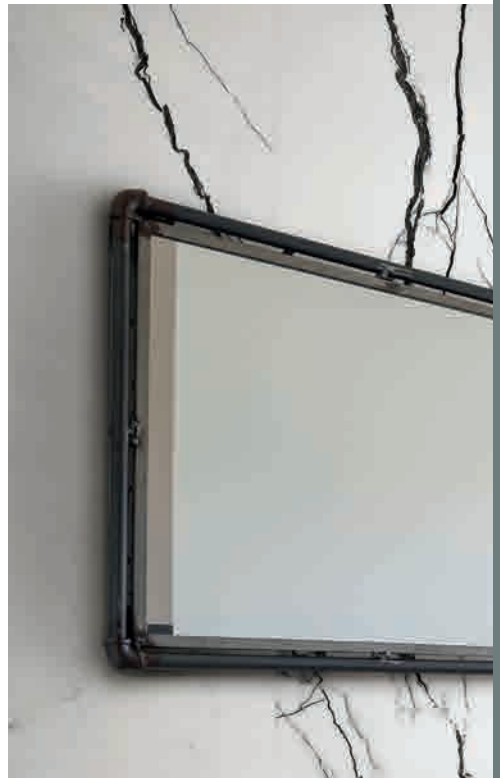



# B&W\_MARBLE

gres fine porcellanato  
fine porcelain stoneware  
grès cérame fin  
feinsteinzeug-kollektionen  
gres porcelánico fino





## B&W\_MARBLE / ELITE

L'idea di dualismo cromatico di "B&W" evolve in "**B&W\_Marble**", la nuova collezione progettuale del marchio Architectural design. La serie propone la purezza di tinta dei due opposti di luce per eccellenza, il bianco e il nero, che diventa lo sfondo dal quale prende vita un "pantone lapideo" composto da un ventaglio di elementi dalle forme più o meno regolari che ricordano le venature del marmo. Il marmo viene inteso come una materia fortemente progettuale legata alla terra e alla natura, rafforzando la proposta di osmosi tra ambiente naturale e ambiente costruito tipica del marchio Florim.

The "B&W" idea of chromatic dualism evolves into "**B&W\_Marble**", the new Architectural design collection for architectural projects. The series offers the purity of shades of the most sharply contrasting opposites, white and black, which become the background for a range of "pantone colours in stone", with an assortment of elements of more or less regular shapes that evoke the vein patterns of marble. Marble is viewed here as a material with strong architectural connotations, linked to the earth and nature, reinforcing the concept of osmosis between the natural and built environment typical of the Florim brand.

L'idée de dualisme chromatique de «B&W» évolue en «**B&W\_Marble**», la nouvelle collection conceptuelle de la marque Architectural design. Cette série propose la pureté de teinte des deux opposés par excellence, le blanc et le noir, qui devient le fond donnant vie à un « pantone de pierre » composé d'un éventail d'éléments aux formes plus ou moins régulières qui rappellent les veinures du marbre. Le marbre est perçu comme une matière fortement conceptuelle liée à la terre et à la nature, renforçant ainsi la proposition d'osmose entre environnement naturel et environnement construit typique de la marque Florim.

Aus der Idee des chromatischen Dualismus von „B&W“ entsteht „**B&W\_Marble**“, die neue Designkollektion der Marke Architectural design. Die Serie bietet die Farbreinheit der zwei Lichtgegensätze par excellence, Schwarz und Weiß. Sie bildet den Hintergrund für eine „steingraue Pantone-Farbpalette“, welche sich aus einer Reihe von Elementen mit mehr oder weniger regelmäßigen Formen zusammensetzt, die an Marmoradern erinnern. Unter Marmor ist ein äußerst gestaltbares Material zu verstehen, das mit der Erde und Natur verbunden ist und die Osmoselösung zwischen dem natürlichen Raum und dem vom Menschen erschaffenen Raum verstärkt. Eine Lösung, die für das Markenzeichen Florim so typisch ist.

La idea de dualismo cromático de B&W evoluciona en **B&W\_Marble**, la nueva colección de diseño de la marca Architectural design. La serie propone la pureza cromática de los dos opuestos de luz por excelencia, el blanco y el negro, que deviene el fondo en el que cobra vida un "pantone lítico" compuesto por un abanico de elementos de formas, más o menos regulares, que recuerdan las vetas del mármol. El mármol es considerado una materia de diseño, fuertemente vinculada a la tierra y a la naturaleza, reforzando la propuesta de ósmosis entre el ambiente natural y el ambiente construido, típica de la marca Florim.

# B&W\_MARBLE / ELITE

## WHITE



## BLACK

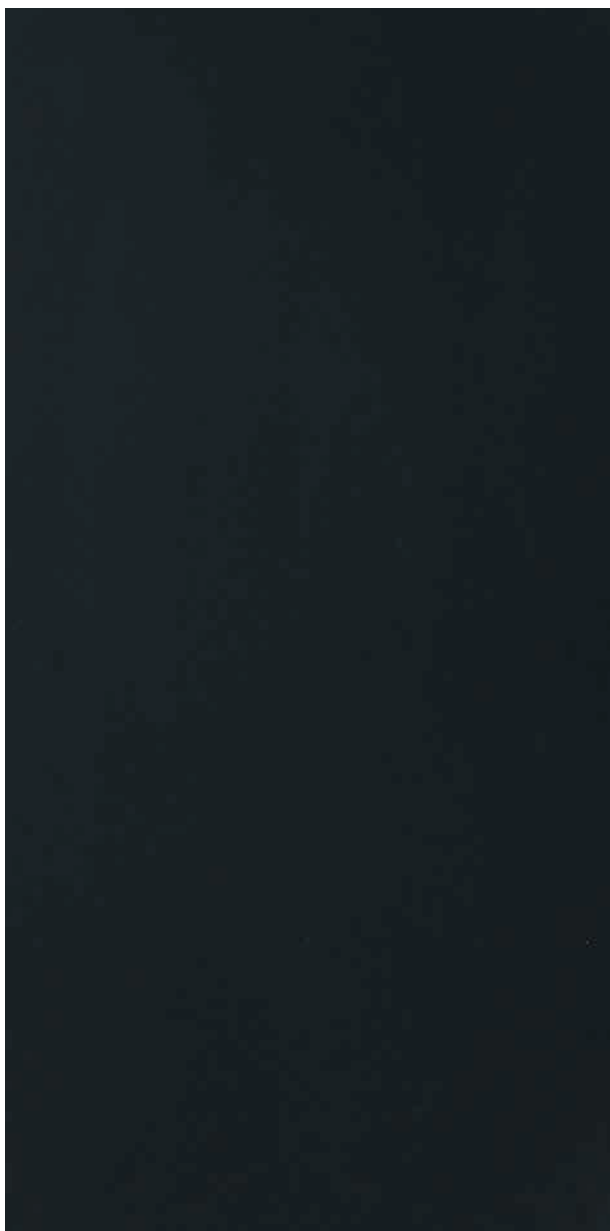

V1

R9  
(naturale)

DCOF>  
0,42 Wet  
(naturale)

9 mm 3/8" ↑↓



V1

R9  
(naturale)

DCOF>  
0,42 Wet  
(naturale)

6 mm 1/4" ↑↓

FLOIRIM OVERSIZE  
magnum

### GRES FINE PORCELLANATO

FINE PORCELAIN STONEWARE / GRÈS CÉRAME FIN / FEINSTEINZEUG-KOLLEKTIONEN / GRES PORCELÁNICO FINO

SQUADRATO - SQUARED - EQUARRI - REKTIFIZIERT - ESCUADRADO

| 9 mm 3/8" ↑↓ | COLOR | SURFACE     | 60x120<br>23 <sup>5/8"</sup> x47 <sup>1/4"</sup> | 60x60<br>23 <sup>5/8"</sup> x23 <sup>5/8"</sup> | 30x60<br>11 <sup>4/5"</sup> x23 <sup>5/8"</sup> |
|--------------|-------|-------------|--|---|---|
| B&W_MARBLE   | WHITE | NATURALE    | 755567   | 755473  | 754462  |
|              |       | HIGH-GLOSSY | 755569   | 755475  | 754464  |
|              | BLACK | NATURALE    | 755566   | 755474  | 754463  |
|              |       | HIGH-GLOSSY | 755568   | 755476  | 754465  |

| 6 mm 1/4" ↑↓ | COLOR | SURFACE     | 160x320<br>63"x126" | 120x280<br>47 <sup>1/4"</sup> x110 <sup>1/4"</sup> | 120x240<br>47 <sup>1/4"</sup> x94 <sup>1/2"</sup> | 120x120<br>47 <sup>1/4"</sup> x47 <sup>1/4"</sup> | 60x120<br>23 <sup>5/8"</sup> x47 <sup>1/4"</sup> |
|--------------|-------|-------------|---------------------|--|---|---|--|
| B&W_MARBLE   | WHITE | NATURALE    | 751164              | 765518   | 751165  | 751167  | 751166   |
|              |       | HIGH-GLOSSY | 751171              | 765527   | 751172  | 751174  | 751173   |
|              | BLACK | NATURALE    | 751178              | 765515   | 751179  | 751181  | 751180   |
|              |       | HIGH-GLOSSY | 751185              | 765525   | 751186  | 751188  | 751187   |



## BREACH



V3

R9

(naturale)

DCOF>  
0,42 Wet  
(naturale)

9 mm 3/8" ↑↓



V3

R9

(naturale)

DCOF>  
0,42 Wet  
(naturale)

6 mm 1/4" ↑↓

FLOORM OVERSIZE  
magnUm





### GRES FINE PORCELLANATO

FINE PORCELAIN STONEWARE / GRÈS CÉRAME FIN / FEINSTEINZEUG-KOLLEKTIONEN / GRES PORCELÁNICO FINO  
SQUADRATO - SQUARED - EQUARRI - REKTIFIZIERT - ESCUADRADO





| 9 mm 3/8" ↑↓  | COLOR  | SURFACE     | 60x120<br>23 <sup>5/8"</sup> x47 <sup>1/4"</sup> | 60x60<br>23 <sup>5/8"</sup> x23 <sup>5/8"</sup> | 30x60<br>11 <sup>4/5"</sup> x23 <sup>5/8"</sup> |
|---|--------|-------------|--|---|---|
| <b>B&amp;W_MARBLE</b>  | BREACH | NATURALE    | 766401   | 766598  | 766587  |
|   |        | HIGH-GLOSSY | 766402   | 766603  | 766593  |

| 6 mm 1/4" ↑↓  | COLOR  | SURFACE     | 160x320<br>63"x126" | 120x280<br>47 <sup>1/4"</sup> x110 <sup>1/4"</sup> | 120x240<br>47 <sup>1/4"</sup> x94 <sup>1/2"</sup> | 120x120<br>47 <sup>1/4"</sup> x47 <sup>1/4"</sup> | 60x120<br>23 <sup>5/8"</sup> x47 <sup>1/4"</sup> |
|---|--------|-------------|---------------------|--|---|---|--|
| <b>B&amp;W_MARBLE</b>  | BREACH | NATURALE    | 765497              | 765521   | 765539  | 765566  | 765586   |
|   |        | HIGH-GLOSSY | 765503              | 765533   | 765545  | 765575  | 765596   |

# B&W\_MARBLE / ELITE

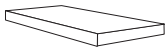
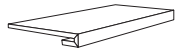
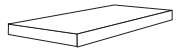
| 9 mm 3/8" ↑↓          |   |        |             |  |
|-----------------------|---|--------|-------------|--|
|                       |   | COLOR  | SURFACE     | <b>30x30</b><br>11 4/5" x 11 4/5"<br><br>mosaico tessere 3x3<br>pz/box 11 |
| <b>B&amp;W_MARBLE</b> |  | WHITE  | NATURALE    | 767385   |
|                       |   |        | HIGH-GLOSSY | 767376   |
|                       |  | BLACK  | NATURALE    | 767386   |
|                       |   |        | HIGH-GLOSSY | 767377   |
|                       |  | BREACH | NATURALE    | 767389   |
|                       |   |        | HIGH-GLOSSY | 767380   |









## PEZZI SPECIALI/SPECIAL TRIMS/PIÈCES SPÉCIALES/FORMSTÜCKE/PIEZAS ESPECIALES

| 9 mm 3/8" ↑↓          |   |        |             |  |  |   |   |
|-----------------------|---|--------|-------------|--|--|---|---|
|                       |   | COLOR  | SURFACE     | <b>4,6x60</b><br>1 4/5" x 23 5/8"<br><br>battiscopa | <b>33x120x3</b><br>13" x 47 1/4" x 1 1/8"<br><br>angolo gradino DX<br>pz/box 2 | <b>33x120x3</b><br>13" x 47 1/4" x 1 1/8"<br><br>gradino<br>pz/box 2 | <b>33x120x3</b><br>13" x 47 1/4" x 1 1/8"<br><br>angolo gradino SX<br>pz/box 2 |
| <b>B&amp;W_MARBLE</b> |   | WHITE  | NATURALE    | 756613   | 767430   | 767422  | 767438  |
|                       |   |        | HIGH-GLOSSY | 756611   | -  | -   | -   |
|                       |  | BLACK  | NATURALE    | 756614   | 767431   | 767423  | 767439  |
|                       |   |        | HIGH-GLOSSY | 756612   | -  | -   | -   |
|                       |  | BREACH | NATURALE    | 767417   | 767434   | 767426  | 767442  |
|                       |   |        | HIGH-GLOSSY | 767411   | -  | -   | -   |

**Per un effetto ottimale della posa, Florim suggerisce di mantenere 2 mm di fuga per pose monoformato e 3 mm per combinare formati misti** - For optimal installation results, Florim recommends maintaining a joint of 2 mm 1/12" for single format installations and 3 mm 1/8" to combine mixed formats. - Pour réaliser une pose parfait, Florim conseille de laisser 2 mm de joint pour la pose des monoformats et 3 mm pour les combinaisons de formats mixtes. - Um einen optimalen effekt beim verlegen zu erzielen empfiehlt Florim eine 2 mm fugen bei einformatigen verlegungen und 3 mm fugen bei formatkombinationen - Para lograr los maximos resultados en la posa del producto, Florim aconseja 2 mm de junta en aplicaciones monoformato y 3 mm en combinaciones de formatos mixtos

**In relazione alle differenti tecnologie produttive l'accostamento di prodotti con spessori diversi potrebbe presentare delle disomogeneità, se ne sconsiglia pertanto l'abbinamento.** / Due to the different production technologies, contiguous installation of products with different thickness may give a non-homogeneous result. For this reason we do not recommend this option. / Vu que différentes technologies de production sont utilisées avec des épaisseurs différentes, des problèmes d'homogénéité pourraient se présenter, il est donc déconseillé de les poser ensemble. / Wegen unterschiedlicher Produktionstechnologien können die Fliesen mit verschiedenen Materialstärken optische Differenzen aufweisen. Von einem direkten Aneinanderlegen wird deshalb abgeraten. / Dadas las diferentes tecnologías productivas, la combinación de productos de diferentes espesores podría dar lugar a heterogeneidad, por lo que se desaconseja mezclarlas.

PEZZI SPECIALI/SPECIAL TRIMS/PIÈCES SPÉCIALES/FORMSTÜCKE/PIEZAS ESPECIALES

| 6 mm 1/4"  |   | COLOR  | SURFACE     | 30x30<br>11 4/5" x 11 4/5"<br><br>mosaico<br>tessere 7,5x7,5<br>pz/box 11 | 30x30<br>11 4/5" x 11 4/5"<br><br>muretto<br>tessere 7,5x15<br>pz/box 11 | 30x30<br>11 4/5" x 11 4/5"<br><br>mosaico<br>tessere 1,5x3<br>pz/box 11 | 4,6x80<br>1 4/5" x 31 1/2"<br><br>battiscopa |
|---|---|--------|-------------|--|---|--|---|
| <b>B&amp;W_MARBLE</b>   |  | WHITE  | NATURALE    | 751192   | 751196  | 751200   | 751204  |
|   |   |        | HIGH-GLOSSY | 751194   | 751198  | 751202   | 751206  |
|   |  | BLACK  | NATURALE    | 751193   | 751197  | 751201   | 751205  |
|   |   |        | HIGH-GLOSSY | 751195   | 751199  | 751203   | 751207  |
|   |  | BREACH | NATURALE    | 767454   | 767466  | 767478   | 767490  |
|   |   |        | HIGH-GLOSSY | 767448   | 767460  | 767472   | 767484  |

| 6 mm 1/4"  |  | COLOR | SURFACE | 60x120<br>23 5/8" x 47 1/4" |
|---|--|-------|---------|-----------------------------|
|---|--|-------|---------|-----------------------------|

**B&W\_MARBLE**



B&W DECOR

NATURALE

767918

FLORIM OVERSIZE  
**magnUm**

**160x320/120x280/120x240/120x120/60x120**  
 Specifica Imballo pag.  
 Packaging specifications on page  
 Spécifications d'emballage à page  
 Verpackungsdetail Seite  
 Especificaciones de embalaje a la página  
**162/163**

| <b>B&amp;W_MARBLE</b> | scatola - box |      |       | pallet |       |     |
|-----------------------|---------------|------|-------|--------|-------|-----|
|                       | pz            | mq   | kg    | box    | mq    | kg  |
| 60x120                | 2             | 1,44 | 28,44 | 30     | 43,20 | 880 |
| 60x60                 | 3             | 1,08 | 21,33 | 40     | 43,20 | 880 |
| 30x60                 | 6             | 1,08 | 21,33 | 40     | 43,20 | 880 |
| <b>B&amp;W_MARBLE</b> | scatola - box |      |       | pallet |       |     |
|                       | pz            | ml   | kg    | box    | mq    | kg  |
| 4,6x60 battiscopa     | 14            | 8,40 | 8,40  | -      | -     | -   |





# BUILDTECH/2.0

gres fine porcellanato  
fine porcelain stoneware  
grès cérame fin  
feinsteinzeug-kollektionen  
gres porcelánico fino





## BUILDTECH/2.0 / PREMIUM

In **Buildtech/2.0** il tema del cemento si accompagna a quello del colore. Coerenza e costanza nella ricerca hanno permesso di sviluppare un approccio intuitivo fatto di interesse e curiosità verso i possibili modi di vivere. Interprete di uno stile essenziale ma sofisticato che si evidenzia nella possibilità di molteplici combinazioni tra effetti e differenti superfici studiate per integrarsi ed essere protagoniste dei progetti più accattivanti.

The theme of cement goes hand in hand with that of colour in **Buildtech/ 2.0**. Consistency and constancy in research are the hallmarks of our intuitive approach made up of interest and curiosity regarding possible ways of living. An exponent of an essential yet sophisticated style featuring a wide array of possible combinations of effects and different surfaces designed to complement and star in eye-catching projects.

Dans **Buildtech/ 2.0** le thème du ciment s'accompagne de celui de la couleur. Une recherche cohérente et constante a permis de développer une approche intuitive faite d'intérêt et de curiosité pour les différents modes de vie possibles. Interprète d'un style à la fois essentiel et sophistiqué révélé par les multiples combinaisons d'effets et les différentes surfaces étudiées pour s'intégrer et être protagonistes des projets les plus séduisants.

In **Buildtech/ 2.0** geht das Thema Zement mit der Farbe einher. Dank einer kohärenten und konstanten Forschungstätigkeit wurde ein intuitiver Ansatz entwickelt, der auf dem Interesse und der Neugierde für mögliche Lebensweisen basiert. Der Interpret eines aufs Wesentliche beschränkte, nichtsdestotrotz jedoch edlen Stils, der durch vielfache Kombinationsmöglichkeiten von Effekten und verschiedenen Oberflächen hervorgehoben wird, welche sich integrieren und die Protagonisten der attraktivsten Projekte sind.

En **Buildtech/ 2.0** el tema del cemento se acompaña con el del color. Coherencia y constancia en la búsqueda han permitido desarrollar un enfoque intuitivo basado en el interés y en la curiosidad por las posibles formas de vivir. Una colección intérprete de un estilo esencial, aunque sofisticado, que se manifiesta en la posibilidad de múltiples combinaciones entre efectos y distintas superficies estudiadas para integrarse y ser protagonistas de los proyectos más atractivos.

# BUILDTECH/2.0 / PREMIUM

## BUILD\_WHITE CE



## BUILD\_BONE CE



V2

**R10  
CLASSE A**  
(naturale)

**R9**  
(soft)

**R10  
CLASSE B**  
(R+PTV)

**R11  
CLASSE C**  
(strutturato)

DCOF>  
0,42 Wet

BS EN 16165  
ANNEX C  
>36 wet  
slider 96  
(R+PTV)

9 mm 3/8" ↑↓



V2

**R9  
CLASSE A**  
(naturale)

**R10  
CLASSE B**  
(R+PTV)

DCOF>  
0,42 Wet

BS EN 16165  
ANNEX C  
>36 wet  
slider 96  
(R+PTV)

6 mm 1/4" ↑↓

FLOREM OVERSIZE  
**magnUm**

### GRES FINE PORCELLANATO

FINE PORCELAIN STONEWARE / GRÈS CÉRAMÉ FIN / FEINSTEINZEUG-KOLLEKTIONEN / GRES PORCELÁNICO FINO

SQUADRATO - SQUARED - EQUARRI - REKTIFIZIERT - ESCUADRADO

| 9 mm 3/8" ↑↓         |                | COLOR    | SURFACE | 60x120<br>23 <sup>5/8"</sup> x47 <sup>1/4"</sup>  | 80x80<br>31 <sup>1/2"</sup> x31 <sup>1/2"</sup>   | 60x60<br>23 <sup>5/8"</sup> x23 <sup>5/8"</sup>  | 30x60<br>11 <sup>4/5"</sup> x23 <sup>5/8"</sup> |
|----------------------|----------------|----------|---------|---|---|--|---|
| <b>BUILDTECH/2.0</b> | BUILD_WHITE CE | NATURALE |         | 765232  | 765244  | 765264   | 765280  |
|                      |                | SOFT     |         | 765236  | 765248  | 765268   | 765284  |
|                      |                | R+PTV    |         | 765240  | -   | 765276   | 765292  |
|                      | STRUTTURATO    |          | -       | -   | 765272  | 765288   |   |
|                      | BUILD_BONE CE  | NATURALE |         | 765233  | 765245  | 765265   | 765281  |
|                      |                | SOFT     |         | 765237  | 765249  | 765269   | 765285  |
| R+PTV                |                |          | 765241  | -   | 765277  | 765293   |   |
| STRUTTURATO          |                | -        | -       | 765273  | 765289  |  |   |
| 6 mm 1/4" ↑↓         |                | COLOR    | SURFACE | 120x240<br>47 <sup>1/4"</sup> x94 <sup>1/2"</sup> | 120x120<br>47 <sup>1/4"</sup> x47 <sup>1/4"</sup> | 60x120<br>23 <sup>5/8"</sup> x47 <sup>1/4"</sup> |   |
| <b>BUILDTECH/2.0</b> | BUILD_WHITE CE | NATURALE |         | 766105  | 766116  | 766131   |   |
|                      |                | R+PTV    |         | 766110  | 766121  | -  |   |
|                      | BUILD_BONE CE  | NATURALE |         | 766107  | 766118  | 766133   |   |
|                      |                | R+PTV    |         | 766112  | 766123  | -  |   |



## BUILD\_MUD CE



## BUILD\_COAL CE



V2

**R10  
CLASSE A**  
(naturale)

**R9**  
(soft)

**R10  
CLASSE B**  
(R+PTV)

**R11  
CLASSE C**  
(strutturato)

DCOF>  
0,42 Wet

BS EN 16165  
ANNEX C  
>36 wet  
slider 96  
(R+PTV)

9 mm 3/8" ↑↓



V2

**R9  
CLASSE A**  
(naturale)

**R10  
CLASSE B**  
(R+PTV)

DCOF>  
0,42 Wet

BS EN 16165  
ANNEX C  
>36 wet  
slider 96  
(R+PTV)

6 mm 1/4" ↑↓

FLORM OVERSIZE  
magnum

### GRES FINE PORCELLANATO

FINE PORCELAIN STONEWARE / GRÈS CÉRAMÉ FIN / FEINSTEINZEUG-KOLLEKTIONEN / GRES PORCELÁNICO FINO  
SQUADRATO - SQUARED - EQUARRI - REKTIFIZIERT - ESCUADRADO

| 9 mm 3/8" ↑↓  |               | COLOR       | SURFACE | 60x120<br>23 <sup>5/8"</sup> x47 <sup>1/4"</sup>  | 80x80<br>31 <sup>1/2"</sup> x31 <sup>1/2"</sup>   | 60x60<br>23 <sup>5/8"</sup> x23 <sup>5/8"</sup>  | 30x60<br>11 <sup>4/5"</sup> x23 <sup>5/8"</sup> |
|---------------|---------------|-------------|---------|---|---|--|---|
| BUILDTECH/2.0 | BUILD_MUD CE  | NATURALE    |         | 765234  | 765246  | 765266   | 765282  |
|               |               | SOFT        |         | 765238  | 765250  | 765270   | 765286  |
|               |               | R+PTV       |         | 765242  | -   | 765278   | 765294  |
|               |               | STRUTTURATO |         | -   | -   | 765274   | 765290  |
|               | BUILD_COAL CE | NATURALE    |         | 765235  | 765247  | 765267   | 765283  |
|               |               | SOFT        |         | 765239  | 765251  | 765271   | 765287  |
| R+PTV         |               |             | 765243  |   | 765279  | 765295   |   |
|               | STRUTTURATO   |             | -       |   | 765275  | 765291   |   |
| 6 mm 1/4" ↑↓  |               | COLOR       | SURFACE | 120x240<br>47 <sup>1/4"</sup> x94 <sup>1/2"</sup> | 120x120<br>47 <sup>1/4"</sup> x47 <sup>1/4"</sup> | 60x120<br>23 <sup>5/8"</sup> x47 <sup>1/4"</sup> |   |
| BUILDTECH/2.0 | BUILD_MUD CE  | NATURALE    |         | 766108  | 766119  | 766134   |   |
|               |               | R+PTV       |         | 766113  | 766124  | -  |   |
|               | BUILD_COAL CE | NATURALE    |         | 766109  | 766120  | 766135   |   |
|               |               | R+PTV       |         | 766114  | 766125  | -  |   |





FLORM OVERSIZE  
magnum



# Vantaggi tecnici - Technical advantages - Avantages techniques Technische Vorteile - Ventajas técnicas



- Lastra monolitica compatta di spessore 2 cm squadrata e rettificata
- Compact monolithic slab 2 cm thick squared and rectified
- Dalle monolithique compacte de 2 cm d'épaisseur, équarrie et rectifiée
- Kompakte monolithische Platte, 2 cm dick, rechtwinklig und scharfkantig geschliffen
- Losa monolítica compacta de 2 cm de espesor, escuadrada y rectificada.



- INGELIVO
- FROST RESISTANT
- INGÉLIF
- FROSTBESTÄNDIG
- RESISTENTE A LA HELADA

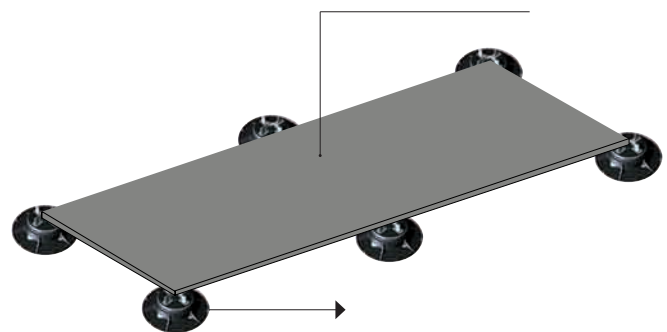
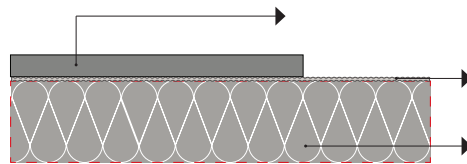
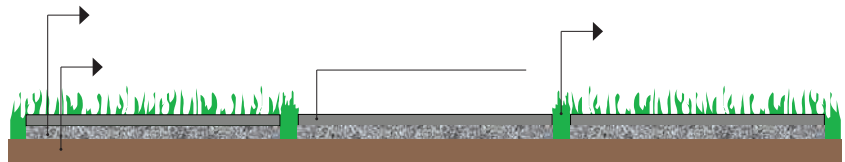
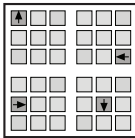
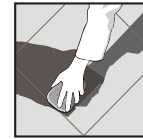
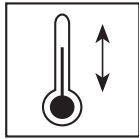
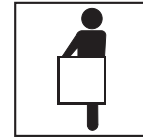

## BUILD\_WHITE CE

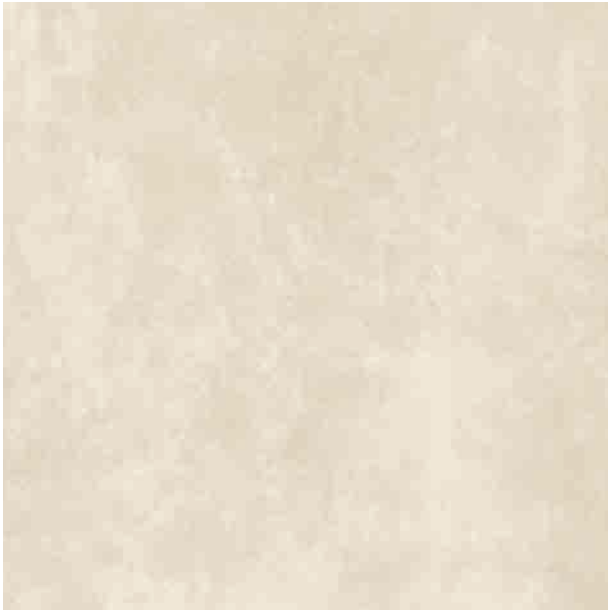

## BUILD\_BONE CE

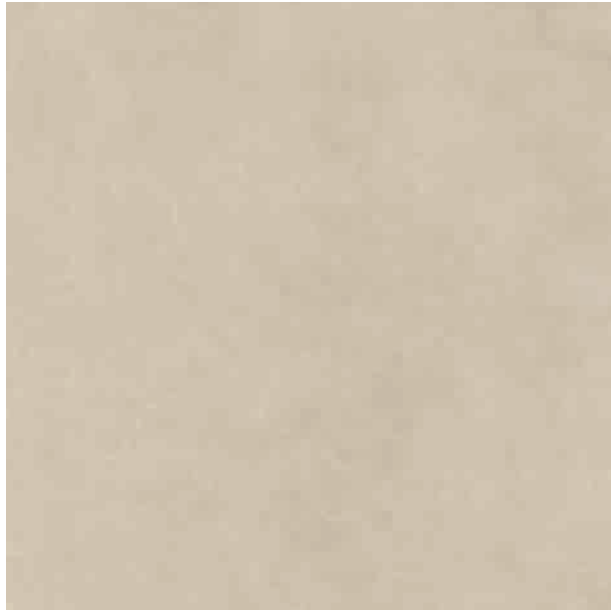

**R11  
CLASSE C**

DCOF>  
0,42 Wet

**20 mm 3/4"** ↑↓

## BUILD\_MUD CE



## BUILD\_COAL CE



### GRES FINE PORCELLANATO

FINE PORCELAIN STONEWARE/GRES CERAME FIN/FEINSTEINZEUG-KOLLEKTIONEN/GRES PORCELANICO FINO  
SQUADRATO - SQUARED - EQUARRI - REKTIFIZIERT - ESCUADRADO

**20 mm 3/4"** ↑↓

|                      | COLOR          | SURFACE     | 60x120<br>23 <sup>5/8"</sup> x47 <sup>1/4"</sup> |
|----------------------|----------------|-------------|--|
| <b>BUILDTECH/2.0</b> | BUILD_WHITE CE | STRUTTURATO | 765296   |
|                      | BUILD_BONE CE  | STRUTTURATO | 765297   |
|                      | BUILD_MUD CE   | STRUTTURATO | 765298   |
|                      | BUILD_COAL CE  | STRUTTURATO | 765299   |



**20mm  
BUILD\_BONE - BUILD\_MUD - BUILD\_COAL**

| ISO 10545-4 | RESISTENZA ALLA FLESSIONE IN N/mm <sup>2</sup><br>N/mm <sup>2</sup> FLEXURAL STRENGTH TEST / RESISTANCE<br>A LA FLEXION EN N/mm <sup>2</sup> / BIEGEFESTIGKEIT IN<br>N/mm <sup>2</sup> / RESISTENCIA A LA FLEXION EN N/mm <sup>2</sup> | valore medio<br>52 N/mm <sup>2</sup> |
|-------------|--|--------------------------------------|
|             | Forza di rottura in N (ep. > 7,5 mm)<br>Breaking strength in N (ep. > 7,5 mm) / Force de<br>rupture en N (ep. > 7,5 mm) / Bruchlast in N (Dicke ><br>7,5 mm) / Fuerza de rotura en N (g. > 7,5 mm)                                     | valore medio<br>14000 N              |

| <b>BUILDTECH/2.0</b> | scatola - box |      |       | pallet |       |      |
|----------------------|---------------|------|-------|--------|-------|------|
|                      | pz            | mq   | kg    | box    | mq    | kg   |
| 60x120 20mm          | 1             | 0,72 | 32,26 | 30     | 21,60 | 1000 |



# BUILDTECH/2.0 / PREMIUM



## CREAM

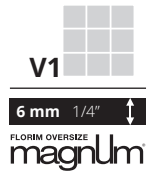
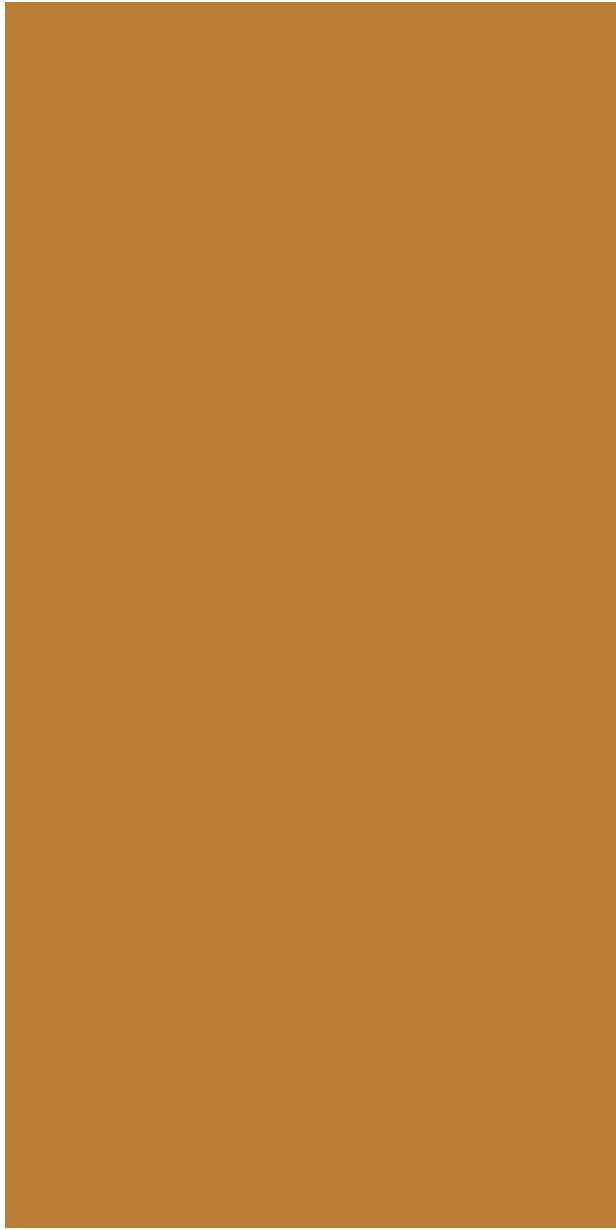

## MUSTARD



**GRES PORCELLANATO DECORATO**  
 DECORATED PORCELAIN TILES/GRÈS CÉRAMÉ DÉCORÉ/VERZIERTES FEINSTEINZEUG/GRES PORCELÁNICO DECORADO  
 SQUADRATO - SQUARED - EQUARRI - REKTIFIZIERT - ESCUADRADO

|                      |   |         |          | <b>120x280</b><br>47 <sup>1/4"</sup> x110 <sup>1/4"</sup> | <b>120x240</b><br>47 <sup>1/4"</sup> x94 <sup>1/2"</sup> | <b>120x120</b><br>47 <sup>1/4"</sup> x47 <sup>1/4"</sup> | <b>60x120</b><br>23 <sup>5/8"</sup> x47 <sup>1/4"</sup> |
|----------------------|---|---------|----------|---|--|--|---|
| <b>BUILDTECH/2.0</b> |  | CREAM   | GLOSSY   | 766859  | 766674   | 766879   | 766900  |
|                      |   |         | NATURALE | 766849  | 766660   | 766869   | 766890  |
|                      |  | MUSTARD | GLOSSY   | 766858  | 766672   | 766878   | 766899  |
|                      |   |         | NATURALE | 766848  | 766659   | 766868   | 766889  |

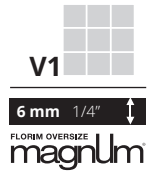

## SCARLET

## CRIMSON



### GRES PORCELLANATO DECORATO

DECORATED PORCELAIN TILES/GRÈS CÉRAMÉ DÉCORÉ/VERZIERTES FEINSTEINZEUG/GRES PORCELÁNICO DECORADO  
SQUADRATO - SQUARED - EQUARRI - REKTIFIZIERT - ESCUADRADO

|                      |   |         |          | <b>120x280</b><br>47 <sup>1/8</sup> "x110 <sup>1/4</sup> " | <b>120x240</b><br>47 <sup>1/8</sup> "x94 <sup>1/2</sup> " | <b>120x120</b><br>47 <sup>1/8</sup> "x47 <sup>1/8</sup> " | <b>60x120</b><br>23 <sup>5/8</sup> "x47 <sup>1/8</sup> " |
|----------------------|---|---------|----------|--|---|---|--|
| <b>BUILDTech/2.0</b> |  | SCARLET | GLOSSY   | 766862   | 766677  | 766882  | 766903   |
|                      |   |         | NATURALE | 766852   | 766663  | 766872  | 766893   |
|                      |  | CRIMSON | GLOSSY   | 766863   | 766678  | 766883  | 766904   |
|                      |   |         | NATURALE | 766853   | 766665  | 766873  | 766894   |

# BUILDTECH/2.0 / PREMIUM



## FUCHSIA

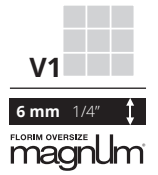

## BURGUNDY



**GRES PORCELLANATO DECORATO**  
 DECORATED PORCELAIN TILES/GRÈS CÉRAMÉ DÉCORÉ/VERZIERTES FEINSTEINZEUG/GRES PORCELÁNICO DECORADO  
 SQUADRATO - SQUARED - EQUARRI - REKTIFIZIERT - ESCUADRADO

|                      |   |          |          | <b>120x280</b><br>47 <sup>1/4"</sup> x110 <sup>1/4"</sup> | <b>120x240</b><br>47 <sup>1/4"</sup> x94 <sup>1/2"</sup> | <b>120x120</b><br>47 <sup>1/4"</sup> x47 <sup>1/4"</sup> | <b>60x120</b><br>23 <sup>5/8"</sup> x47 <sup>1/4"</sup> |
|----------------------|---|----------|----------|---|--|--|---|
| <b>BUILDTECH/2.0</b> |  | FUCHSIA  | GLOSSY   | 766865  | 766680   | 766885   | 766906  |
|                      |   |          | NATURALE | 766855  | 766667   | 766875   | 766896  |
|                      |  | BURGUNDY | GLOSSY   | 766864  | 766679   | 766884   | 766905  |
|                      |   |          | NATURALE | 766854  | 766666   | 766874   | 766895  |

## SKY

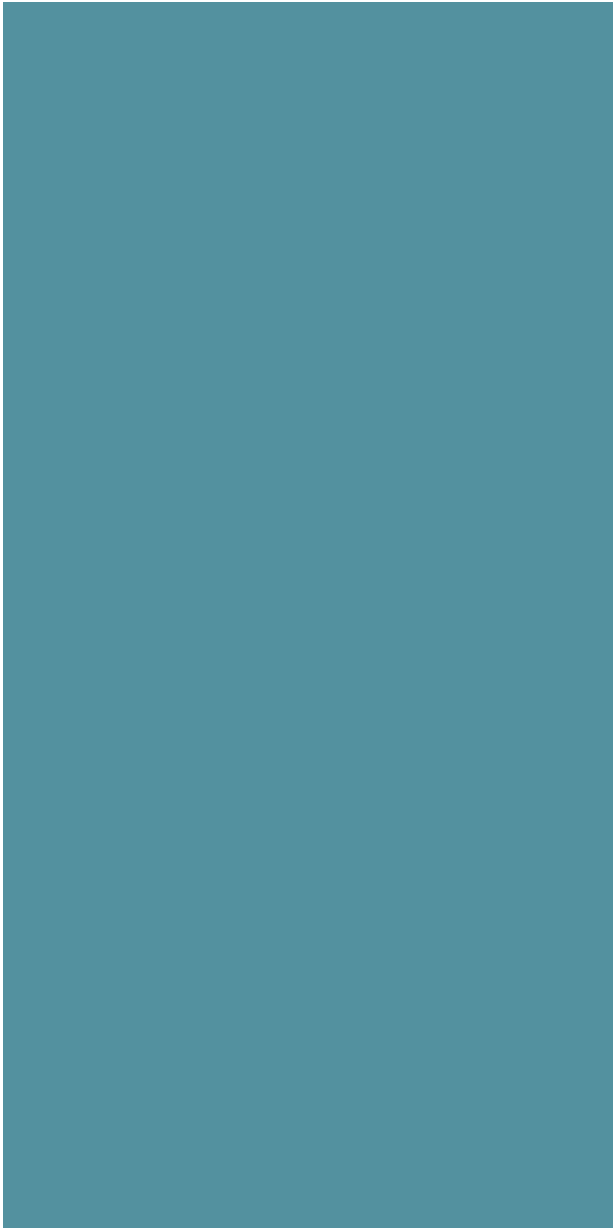

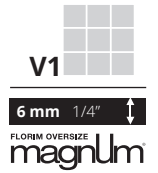

## MIDNIGHT



### GRES PORCELLANATO DECORATO

DECORATED PORCELAIN TILES/GRÈS CÉRAMÉ DÉCORÉ/VERZIERTES FEINSTEINZEUG/GRES PORCELÁNICO DECORADO  
SQUADRATO - SQUARED - EQUARRI - REKTIFIZIERT - ESCUADRADO

| 6 mm 1/4" ↑↓         |   | COLOR    | SURFACE  | 120x280<br>47 <sup>1/4"</sup> x110 <sup>1/4"</sup> | 120x240<br>47 <sup>1/4"</sup> x94 <sup>1/2"</sup> | 120x120<br>47 <sup>1/4"</sup> x47 <sup>1/4"</sup> | 60x120<br>23 <sup>5/8"</sup> x47 <sup>1/4"</sup> |
|----------------------|---|----------|----------|--|---|---|--|
| <b>BUILDTECH/2.0</b> |  | SKY      | GLOSSY   | 766861   | 766676  | 766881  | 766902   |
|                      |   |          | NATURALE | 766851   | 766662  | 766871  | 766892   |
|                      |  | MIDNIGHT | GLOSSY   | 766860   | 766675  | 766880  | 766901   |
|                      |   |          | NATURALE | 766850   | 766661  | 766870  | 766891   |

# BUILDTECH/2.0 / PREMIUM



## TEAL

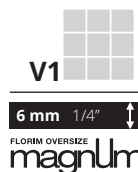
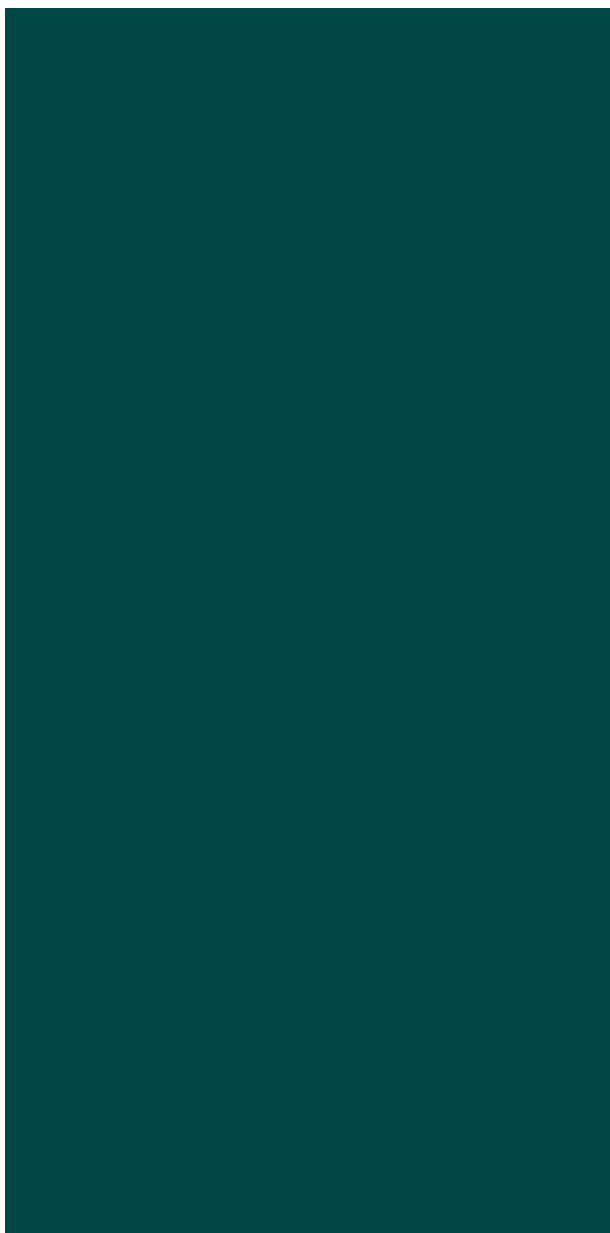

## BOTTLE



**GRES PORCELLANATO DECORATO**  
 DECORATED PORCELAIN TILES/GRÈS CÉRAMÉ DÉCORÉ/VERZIERTES FEINSTEINZEUG/GRES PORCELÁNICO DECORADO  
 SQUADRATO - SQUARED - EQUARRI - REKTIFIZIERT - ESCUADRADO

| 6 mm 1/4" ↑↓         |   | COLOR  | SURFACE  | 120x280<br>47 <sup>13/16</sup> "x110 <sup>1/4</sup> " | 120x240<br>47 <sup>13/16</sup> "x94 <sup>1/2</sup> " | 120x120<br>47 <sup>13/16</sup> "x47 <sup>13/16</sup> " | 60x120<br>23 <sup>5/8</sup> "x47 <sup>13/16</sup> " |
|----------------------|---|--------|----------|---|--|--|---|
| <b>BUILDTECH/2.0</b> |  | TEAL   | GLOSSY   | 766856  | 766668   | 766876   | 766897  |
|                      |   |        | NATURALE | 766846  | 766657   | 766866   | 766886  |
|                      |  | BOTTLE | GLOSSY   | 766857  | 766671   | 766877   | 766898  |
|                      |   |        | NATURALE | 766847  | 766658   | 766867   | 766888  |

FLORIM OVERSIZE  
**magnUm**

**120x280/120x240/120x120/60x120**  
 Specifica Imballo pag.  
 Packaging specifications on page  
 Spécifications d'emballage à page  
 Verpackungsdetail Seite  
 Especificaciones de embalaje a la página  
**162/163**



## GRES PORCELLANATO DECORATO

DECORATED PORCELAIN TILES/GRÉS CÉRAMÉ DÉCORÉ/VERZIERTES FEINSTEINZEUG/GRES PORCELÁNICO DECORADO

## AVVERTENZE / WARNINGS / AVERTISSEMENTS / HINWEISE / ADVERTENCIAS

|   |  |
|---|--|
| <p><b>INDICAZIONI GENERALI</b><br/>GENERAL INSTRUCTIONS<br/>INDICATIONS GÉNÉRALES<br/>ALLGEMEINE HINWEISE<br/>INDICATIONS GÉNÉRALES</p>   | <p>Florim indica di stoccare il materiale in magazzini coperti o al riparo da agenti atmosferici, coprendo il materiale con cappucci protettivi; è NECESSARIO EVITARE OGNI TIPO DI STROFINAMENTO O TRAUMA SUPERFICIALE DELLA LASTRA DURANTE TUTTE LE FASI DI MOVIMENTAZIONE POSA E STUCCATURA. I prodotti in gres porcellanato decorato sono realizzati con una tecnologia produttiva differente dai prodotti in gres porcellanato tradizionale. Nel caso in cui si intenda posare le due tipologie di materiale nello stesso ambiente si potrebbero verificare differenze di aspetto superficiale e "punto di colore". / Florim recommends storing the material in indoor warehouses or protected from the weather, covered with protective hoods. CARE MUST BE TAKEN TO PREVENT ANY RUBBING OF OR KNOCKS ON THE SURFACE OF THE SLAB THROUGHOUT ALL HANDLING, INSTALLATION AND GROUTING PHASES. The decorated porcelain stoneware products are made with a production technology which differs from traditional porcelain stoneware production. If you plan to install the two types of material in the same area, there could be differences in surface appearance and "color point". Florim advises you to avoid rubbing or trauma to the surface of the product, during all the phases of the work. TOOLS AND TYPES OF MOVEMENTS TO BE AVOIDED. DE LA MANUTENTION ET DE L'EXÉCUTION DES JOINTS./Les produits en grés céramé décorés sont fabriqués à l'aide d'une technologie de production différente des produits en grés céramé traditionnels. Si vous avez l'intention de poser les deux types de matériaux dans la même pièce, il pourrait y avoir des différences d'aspect de surface et de "point de couleur". / Florim empfiehlt, das Material in geschlossenen Lagern bzw. vor Witterung geschützt aufzubewahren und mit Schutzplanen abzudecken. BEI HANDLING, VERLEGUNG UND VERFUGUNG SIND REIBEKONTAKTE UND VERLETZUNGEN DER OBERFLÄCHE ZU VERMEIDEN. Die dekorierten Feinsteinzeugprodukte werden mit einer anderen Produktionstechnologie hergestellt, als die traditionellen Feinsteinzeugprodukte. Wenn Sie die beiden Materialarten in derselben Umgebung verlegen möchten, kann es zu Unterschieden in Oberflächenoptik und Farbton kommen./Florim indica que el material debe guardarse, tapado con capuchas de protección, en almacenes cubiertos al amparo de los agentes atmosféricos. DURANTE TODAS LAS FASES DE DESPLAZAMIENTO, COLOCACIÓN Y REJUNTADO EVITESE CAUSAR CUALQUIER TIPO DE ROZAMIENTO O DE TRAUMA SOBRE LA SUPERFICIE DE LA PLACA. Los productos de gres porcelánico decorado se elaboran con una tecnología de producción diferente a los productos tradicionales de gres porcelánico. En el caso tal que se requiera colocar los dos tipos de material en el mismo entorno, pueden haber diferencias en la apariencia de la superficie y el "punto de color".</p>   |
| <p><b>DESTINAZIONE D'USO</b><br/>RECOMMENDED APPLICATIONS<br/>DOMAINE D'APPLICATION<br/>ANWENDUNGSBEREICHE<br/>USO PREVISTO</p>           | <p>Lastre decorate con innovative tecniche artigianali destinate esclusivamente al rivestimento di pareti interne. Eventuali piccole imperfezioni sono da considerarsi caratteristica propria di prodotto dovuta al processo produttivo. Questa innovativa tecnica decorativa migliora la definizione e la profondità dei colori, rendendo la resistenza superficiale all'abrasione meno performante rispetto al gres porcellanato tradizionale. Per questo motivo è necessario attenersi alle istruzioni riportate negli imballi (qualora non fossero presenti, è possibile consultare il sito internet). Il materiale è utilizzabile anche come rivestimento della parete della doccia. In questa destinazione d'uso, per la corretta posa in opera, Florim raccomanda di installare solo lastre intere o posizionare i tagli della lastra non a contatto con il piatto doccia. In caso di utilizzo come backslash, Florim richiede l'installazione delle lastre a una distanza minima di 20 cm dai fuochi del piano cottura. Si consiglia l'utilizzo del materiale come rivestimento di camini, stufe e, più in generale, la posa in prossimità di fonti di calore. / Slabs decorated by innovative hand techniques intended only for covering interior walls. Any minor flaws are an intrinsic characteristic of the product, due to the production process. This innovative decorative technique improves the definition and depth of the colours but reduces resistance to surface abrasion compared to standard porcelain stoneware. The instructions provided inside the packaging must therefore be complied with (if not found, refer to the website). The material can also be used to cover the walls of showers. For this intended use, for correct installation, Florim advises you to install whole slabs only, or to ensure that cut edges of slabs are not in contact with the shower tray. In case of use as a backslash, Florim specifies that slabs must be installed at least 20 cm from hot burners. The material is not recommended for use for covering fireplaces or stoves, or for installation close to heat sources in general. / Dalles décorées par des techniques artisanales modernes, à utiliser exclusivement pour le revêtement des murs intérieurs. Les petites imperfections éventuelles doivent être considérées comme des caractéristiques du produit. Cette technique décorative améliore la définition et la profondeur des couleurs, mais diminue la résistance à l'abrasion de la surface. Pour cette raison, les instructions contenues dans les emballages doivent être suivies à la lettre (si la boîte ne les contient pas, il est possible de consulter le site Internet). Le produit peut être posé aussi sur le mur de la douche. Dans ce cas, pour un bon résultat de pose, Florim conseille d'installer uniquement des dalles entières ou de ne pas mettre les découpes de la dalle en contact avec le receveur. Si les dalles sont posées en dossier, Florim préconise de ne pas les placer à moins de 20 cm des feux de la table de cuisson. Il est déconseillé d'utiliser le produit pour revêtir des cheminées, des poêles et, de manière plus générale, de le poser à proximité de sources de chaleur. / Dekorierte Platten, hergestellt mit modernen Handwerkstechniken, ausschließlich für die Wandverkleidung im Innenbereich. Eventuelle geringfügige Unregelmäßigkeiten sind keine Mängel, sondern ein typisches Merkmal des Produkts. Diese dekorative Technik verbessert die Definition und die Tiefe der Farben, verringert aber die Abriebfestigkeit der Oberfläche. Aus diesem Grund beachten Sie bitte genau die beigezeichnete Anleitung (sollten diese nicht vorhanden sein, informieren Sie sich bitte auf der Website). Das Material kann auch für die Wandverkleidung von Duschnischen verwendet werden. In diesem Fall empfiehlt Florim, nur ganze Platten zu verlegen bzw. die Schnittflächen der Platte nicht im Kontakt mit der Duschwanne zu verlegen. Bei Verwendung für Fliesenspiegel soll der Abstand der Platten von den Herdstellen des Kochfelds mindestens 20 cm betragen. Die Verwendung der Platten für die Verkleidung von Kaminen und Öfen bzw. die Verwendung in der Nähe von Wärmequellen wird nicht empfohlen./Placas decoradas con innovadoras técnicas artesanales destinadas exclusivamente al revestimiento de paredes interiores. Toda posible pequeña imperfección ha de considerarse característica propia del producto debida al proceso de fabricación. Esta innovadora técnica decorativa mejora la definición de los colores, pero hace que la resistencia superficial a la abrasión sea menos performante que la del gres porcelánico tradicional. Por este motivo hay que atenderse a las instrucciones que se encuentran en los embalajes (si no las hay, siempre pueden consultarse en el sitio web). El material también se puede utilizar para revestir la pared de la ducha. En el caso de este tipo de aplicación, para una correcta colocación, Florim recomienda instalar únicamente placas enteras o situar los recortes de placas donde no entren en contacto con el plato de la ducha. En caso de uso como salpicadero, Florim exige la colocación de las placas a una distancia mínima de 20 cm de los fogones de la superficie de cocción. Se desaconseja el empleo de este material para revestir chimeneas, estufas y, más en general, superficies cercanas a fuentes de calor.</p> |
| <p><b>MOVIMENTAZIONE</b><br/>HANDLING<br/>MANUTENTION<br/>TRANSPORT UND HANDHABUNG<br/>DESPLAZAMIENTO</p>                                 | <p>Nella movimentazione evitare il contatto con materiali abrasivi e lo strofinamento con altre lastre o con il piano di lavoro. Non appoggiare sulla superficie utensili o altro materiale che potrebbe danneggiare il prodotto. Si consiglia di movimentare le lastre utilizzando appositi telai a ventosa, assicurandosi che le ventose siano perfettamente pulite e avendo cura di: -utilizzare ventose dotate di vacuometro per valutare/verificare la correttezza e costante aderenza delle ventose stesse alla lastra (per movimentare lastre lucide è possibile mantenere la pellicola); - definire il numero di operatori addetti alla fase di movimentazione sulla base del peso totale (lastra più telaio) da sollevare e di eventuali limiti imposti da norme antinfortunistiche. - ridurre al minimo (pochi metri) il tragitto di movimentazione manuale con ventosa. / When handling, avoid contact with abrasive materials or rubbing against other slabs or the work surface. Do not place tools or any other material which might damage the product on the surface. Special suction cup frames should be used when handling slabs, making sure that the suction cups are perfectly clean and always - using suction cups with vacuum meter, for measuring/checking correct, constant adhesion between the suction cups and the slab (when handling glossy slabs, the film can be left in place); - deciding the number of workers to be assigned to handling operations on the basis of the total weight (slab plus frame) to be lifted and any limits set by safety regulations; - minimising (to just a few metres) the distance over which slabs are carried by hand with suction cup. / Pendant la manutention, éviter tout contact avec les matériaux abrasifs et tout frottement avec d'autres dalles ou avec le plan de travail. Ne pas poser sur la surface des outils ou autre matériel susceptibles d'endommager le produit. Il est recommandé d'utiliser les araignées à ventouses pour manutentionner les dalles en s'assurant que les ventouses sont parfaitement propres et en veillant à: - utiliser des ventouses avec un vacuomètre pour évaluer/vérifier la corréctez et constante adhérence des ventouses elles-mêmes à la plaque (pour déplacer des dalles brillantes, il est possible de maintenir la pellicule de protection); - définir le nombre d'opérateurs nécessaires à la manutention selon le poids total (dalle + araignée) à soulever et selon les éventuelles restrictions imposées par les normes relatives à la prévention des accidents. - réduire au minimum (quelques mètres) le parcours de manutention manuelle avec ventouse. / Bei der Handhabung sind der Kontakt mit scharferen Materialien und der Reibekontakt mit anderen Platten oder der Werkbank zu vermeiden. Werkzeuge oder anderweitige Gegenstände, die das Produkt beschädigen könnten, dürfen nicht auf der Oberfläche abgelegt werden. Es wird empfohlen, für das Tragen und Heben der Platten einen Heberahmen mit Saugtellern zu verwenden. Hierbei ist sicherzustellen, dass die Saugteller vollkommen sauber sind, und ist auf Folgendes zu achten: -Die Saugteller sollen mit einem Vakuummeter ausgestattet sein, um Ihre sichere und konstante Haftung an der Platte beurteilen/kontrollieren zu können (für das Handling von glänzenden Platten kann die Schutzfolie in der Regel verbleiben); - die Anzahl der Mitarbeiter für das Handling der Platte auf der Grundlage des Gesamtgewichts (Platte plus Heberahmen) und eventueller Sicherheitsvorgaben zum Unfallschutz bestimmen. - Der Transportweg für das manuelle Handling der Platte ist auf ein Mindestmaß (wenige Meter) zu reduzieren. / En el desplazamiento evítase el contacto con materiales abrasivos y el roce con otras placas o con la superficie de trabajo. No depositar sobre la superficie herramientas ni ningún material que pueda dañar el producto. Se aconseja desplazar las placas utilizando bastidores dotados de ventosas, cerciorándose previamente de que estas estén perfectamente limpias y procurando: - utilizar ventosas provistas de vacuómetro para evaluar/verificar la corréctez y constante adherencia de las mismas a la placa (en caso de desplazar placas brillantes puede mantenerse la película de protección); - establecer el número de operarios que va a encargarse del desplazamiento en función del peso total (placa más bastidor) que haya de levantarse y de las posibles limitaciones que las normas de prevención de accidentes impongan; - reducir al mínimo (a unos pocos metros) el trayecto de desplazamiento manual con ventosa.</p>  |
| <p><b>TAGLIO/FORNO</b><br/>CUTTING/DROLLING<br/>DÉCOUPE/TROUS<br/>SCHNEIDEN/BOHREN<br/>CORTE/ORIFICIO</p>                                 | <p>Verificare che il piano di appoggio sia perfettamente stabile, pianare, pulito e privo di ogni asperità che possa danneggiare il materiale; è possibile usare come protezione della superficie, quando necessario, il foglio "protettivo/distanziatore" contenuto nell'imballo. Come tagliare le lastre delle diverse collezioni: Buildtech/2.0: incidere il retro della lastra utilizzando appositi strumenti da taglio per lastre avendo cura di rimuovere, prima del taglio, la pellicola protettiva, quando presente. Completare la fase di taglio posizionando la lastra con la faccia decorata rivolta verso l'alto. Asportare eventuali residui di decorazione tagliando con una spugna abrasiva. / Check that the supporting surface is perfectly stable, flat and clean and does not have any rough areas which may damage the material. The "protective/spacer" sheet provided in the packaging can be used to protect the surface when necessary. How to cut slabs from the various collections: Buildtech/2.0: cut into the back of the slab using suitable slab cutting tools, taking care to remove any protective film before cutting. Complete the cutting process by positioning the slab with the décor facing upwards. Remove any residues of the cut decoration with an abrasive sponge gliding from top to bottom./S'assurer que la surface d'appui est parfaitement stable, plane, propre et sans irrégularités susceptibles d'endommager le produit. Il est possible d'utiliser la feuille de protection. /d'espacement contenue dans l'emballage pour protéger la surface, si nécessaire. Comment découper les dalles des différentes collections: Buildtech/2.0: faire une amorce au dos de la dalle en utilisant les outils de coupe appropriés, en retirant la pellicule de protection, quand elle est présente. Terminer la phase de découpe en plaçant la dalle décorée vers le haut. Enlever tous les résidus de décoration coupée à l'aide d'une éponge abrasive avec mouvement de haut en bas./Kontrollieren, dass die Arbeitsunterlage vollkommen stabil, plan und sauber ist und keine Unebenheiten aufweist, die zu Beschädigungen der Platte führen könnten. Für den Oberflächenschutz kann bei Bedarf die in der Verpackung enthaltene Schutz- bzw. Zwischenlagefolie verwendet werden. Platten schneiden: Buildtech/2.0: Die Platten rückseitig unter Verwendung von Plattenschneidwerkzeugen anritzen, nachdem die Schutzfolie, sofern vorhanden, entfernt wurde. Schließen Sie die Schneidphase ab, indem Sie die Platte mit der dekorierten Seite nach oben positionieren. Unregelmässige Schnittkanten der Dekoration mit einem Schleifschwamm von oben nach unten glätten./Comprobar que la superficie sobre la que depositamos las placas sea estable, plana, está perfectamente limpia y carezca de asperezas que puedan dañar el material; cuando sea necesario, para proteger la superficie, podrá usarse la hoja "protectora/distanziadora" que se encontrará en el embalaje. Como cortar las placas de las varias colecciones: Buildtech/2.0: practicar una incisión en la parte posterior de la placa sirviéndose de herramientas de corte para placas; antes de proceder al corte retirar la película de protección, si la hay. Complete la fase de corte colocando la tabla con el lado decorado hacia arriba. Retire los restos de decoración cortados con una esponja abrasiva con un movimiento de arriba hacia abajo.</p>   |
| <p><b>POSA</b><br/>INSTALLATION<br/>POSE<br/>VERLEGEN<br/>COLOCACIÓN</p>  | <p>Si consiglia l'uso di distanziatori livellanti tradizionali. È possibile utilizzare i livellanti a vite dotati di guarnizione protettiva (che deve essere assolutamente pulita per evitare di rovinare/segnare la lastra). / The use of standard levelling spacers is not recommended. Screw levelling spacers with protective gasket (which must be absolutely clean to avoid damaging/mark the slab) may be used. / Il est déconseillé d'utiliser les croisillons nivelants traditionnels. Il est possible d'utiliser les croisillons à vis avec joint de protection (qui doit être absolument propre pour éviter d'abîmer/de marquer la dalle). / Die Verwendung von herkömmlichen Verlegehilfen wird nicht empfohlen. Es können Verlegehilfen mit Schraubsystem verwendet werden, die mit einer Schutzichtung ausgestattet sind (diese muss vollkommen sauber sein, damit keine Beschädigungen/Kratzer an der Platte entstehen). Se desaconseja el uso de separadores de nivelación tradicionales. Se pueden utilizar separadores de nivelación de tornillo dotados de guarnición de protección (que ha de estar perfectamente limpia para evitar estropear/arañar la placa).</p>   |
| <p><b>STUCCATURA</b><br/>GROUTING<br/>RÉALISATION DES JOINTS<br/>VERFUGEN<br/>REJUNTADO</p>   | <p>Si consiglia l'uso di soli sigillanti cementizi a grana fine e spatole in materiale plastico. Si consiglia l'uso di silicone acetico come sigillante. (Attenzione: la pellicola, quando presente, non deve impedire il corretto e completo riempimento della fuga). Proteggere con scotch di carta la superficie prima della sigillatura. Buildtech/2.0 Lucido: applicare il sigillante con spatola di gomma mantenendo la pellicola sulle lastre intere. Per le lastre che sono state tagliate e che quindi non hanno la pellicola, utilizzare scotch di carta sui perimetri e successivamente applicare il sigillante con spatola di gomma. Buildtech/2.0 Opaco: utilizzare scotch di carta sui perimetri e successivamente applicare il sigillante con spatola di gomma. / Only fine-grain cement grouts and plastic trowels should be used. The use of acetoxo silicone as a grout is not recommended. (Important: any film present must not prevent correct, complete filling of the joint). Protect the surface with masking tape before grouting. Glossy Buildtech/2.0: apply the grout with a rubber trowel, keeping the film over the whole slabs. On cut slabs which no longer have the film in place, use masking tape around the edges and then apply the grout with a rubber trowel. / Il est recommandé d'utiliser uniquement des mortiers-ciments à grains fins et des spatules en plastique. Il est déconseillé d'utiliser un silicone acétique pour l'exécution des joints. (Attention: le film de protection, si présent, ne doit pas entraver le remplissage complet du joint). Avant de faire les joints, protéger la surface avec un ruban papier adhésif. Buildtech/2.0 brillant: appliquer le mortier avec une spatule en caoutchouc. / Für die Verfugung empfehlen wir, ausschließlich feinkörnigen zementären Fugenmörtel und einen Gummischieber zu verwenden. Die Verwendung von Acetatsilikonen wird nicht empfohlen. Sofern vorhanden, sollte die Schutzfolie vor der Verfugung vollständig entfernt werden. Bei Verwendung von Acetatsilikonen sollte die Oberfläche unverzüglich mit Wasser nachzuspielen. Keine Lösemittel (Alkohol o.ä.) und Scheuerschwämme verwenden. / Utilizar detergentes neutros y/o agua y limpiar con trapos de microfibra o esponjas suaves. Se pueden utilizar productos acidos anticálcaros al mismo tiempo y cuando, tras su aplicación, se aclare de inmediato la superficie con agua. Evítase el uso de esponjas abrasivas y de disolventes (como alcohol o similares).</p>  |
| <p><b>PULIZIA POST POSA</b><br/>POST-INSTALLATION CLEANING<br/>NETTOYAGE APRÈS POSE<br/>ERSTREINIGUNG<br/>LIMPIEZA TRAS LA COLOCACIÓN</p> | <p>Avere cura di pulire i residui prima dell'indurimento dello stucco con acqua e spugna non abrasiva evitando di danneggiare la superficie della lastra. / Clean away residues thoroughly before the grout sets using water and a non-abrasive sponge, taking care not to damage the surface of the slab. / Avant le durcissement du mortier, prendre soin d'éliminer les résidus avec de l'eau et une éponge non abrasive, en évitant d'endommager la surface de la dalle. / Rückstände sind vor der Aushärtung mit Wasser und einem weichen Schwamm abzuwaschen, wobei darauf zu achten ist, dass die Oberfläche nicht beschädigt wird. / Antes de que se endurezcan, límpiese los restos de rejunte con agua y una esponja no abrasiva procurando no estropear la superficie de la placa.</p>  |
| <p><b>PULIZIA QUOTIDIANA</b><br/>DAILY MAINTENANCE<br/>ENTRETIEN QUOTIDIEN<br/>UNTERHALT/SREINIGUNG<br/>LIMPIEZA COTIDIANA</p>            | <p>Utilizzare detergenti neutri e/o acqua, pulendo con straccio in microfibra o spugna morbida. Prodotti acidi anticallcare possono essere utilizzati avendo cura di risciacquare rapidamente la superficie con acqua dopo l'applicazione. Non utilizzare solventi (alcol e simili) né spugne abrasive. / Use neutral detergents and/or water, cleaning with a microfibre cloth or soft sponge. Acid limescale remover products may be used, but take care to rinse the surface with water quickly after application. Do not use solvents (alcohols and similar substances) or abrasive sponges. / Laver avec des détergents neutres et/ou de l'eau, avec un chiffon microfibre ou une éponge douce. Les produits acides anticallcaires peuvent être utilisés à condition de rincer rapidement la surface à l'eau après application. Ne pas utiliser de solvants (alcools et similaires) ni d'éponges abrasives. / Neutrale Reinigungsmittel und/oder Wasser sowie ein Mikrofasertuch werden für einen weichen Schwamm verwendet. Bei Verwendung von Säurebasierten Entkalkern sollte die Oberfläche unverzüglich mit Wasser nachzuspielen. Keine Lösemittel (Alkohol o.ä.) und Scheuerschwämme verwenden. / Utilizar detergentes neutros y/o agua y limpiar con trapos de microfibra o esponjas suaves. Se pueden utilizar productos acidos anticálcaros al mismo tiempo y cuando, tras su aplicación, se aclare de inmediato la superficie con agua. Evítase el uso de esponjas abrasivas y de disolventes (como alcohol o similares).</p>   |

Gres porcellanato decorato: florim indica di stoccare il materiale in magazzini coperti o al riparo da agenti atmosferici / Florim recommends to stock the goods in covered warehouses, do not expose to the elements Florim conseille de stocker le matériel dans des entrepôts couverts ou à l'abri des agents atmosphériques / Florim empfiehlt, das Material in geschlossenen Lagern oder in vor Witterungseinflüssen geschützten Bereichen zu lagern. / Florim indica almacenar el material en locales cubiertos o protegido de los agentes atmosféricos

Lastre decorate destinate esclusivamente al rivestimento di pareti interne. / Decorated panels designed exclusively for tiling interior walls. / Dalles décorées, exclusivement destinées au revêtement de parois intérieures. Verzierte Platten, ausschließlich zur Verkleidung von Innenwänden bestimmt. / Losas decoradas destinadas exclusivamente al revestimiento de paredes interiores.





# CORETECH

gres fine porcellanato  
fine porcelain stoneware  
grès cérame fin  
feinsteinzeug-kollektionen  
gres porcelánico fino







Questa collezione fa parte del progetto CarbonZero, le superfici Carbon Neutral che compensano tutta la CO<sub>2</sub> emessa durante il loro ciclo di vita.

*This collection is part of CarbonZero project, Florim's Carbon Neutral surfaces offset all the CO<sub>2</sub> emitted during their lifecycle.*



## CORETECH / ELITE

**Coretech** è la collezione di Florim che rende la pietra piacentina, estratta nel cuore delle Prealpi Giulie, ancora più performante per le esigenze dell'architettura contemporanea. Ispirata ad un materiale naturalmente bello, resistente, durabile e lavorabile, Coretech si spinge oltre, per assicurare un approccio sostenibile al costruire.

Florim's **Coretech** collection takes Piasentina stone quarried in the foothills of the Julian Alps and enhances its performance to cater to the needs of contemporary architecture. Inspired by a naturally beautiful, tough and workable yet durable material, Coretech takes things to the next level, ensuring a sustainable approach to construction.

**Coretech** est la collection de Florim qui rend la pierre Piasentina, extraite au cœur des Préalpes juliennes, encore plus adaptée aux besoins de l'architecture contemporaine. Inspirée d'un matériau naturellement beau, résistant, durable et facile à travailler, Coretech va encore plus loin afin de garantir une approche durable de la construction.

**Coretech** ist die Kollektion von Florim, mit der Pietra Piasentina, der im Herzen der Julischen Voralpen gewonnen wird, noch mehr Leistungsfähigkeit erhält und somit den Anforderungen der Zeitgenössischen Architektur bestens gerecht wird. Coretech geht, von diesem natürlich schönen, widerstandsfähigen, haltbaren und verarbeitbaren Material inspiriert, noch ein Stück weiter, um der Baubranche einen nachhaltigen Ansatz zu bieten.

**Coretech** es la colección de Florim que logra que la piedra Piasentina, extraída en el corazón de los Prealpes Julianos, ofrezca un mejor rendimiento para las necesidades de la arquitectura contemporánea. La colección Coretech, inspirada en un material hermoso por naturaleza, resistente, duradero y fácil de trabajar, va más allá para garantizar un enfoque sostenible en la construcción.



# CORETECH / ELITE

## FLAME LIGHT



## BRUSHED LIGHT



**V2**  
**R10**  
 (naturale)  
**CLASSE B**  
 (naturale  
 flame light)

**R11**  
 (R+PTV)

DCOF>  
 0,42 Wet

BS EN 16165  
 ANNEX C  
 >36 wet  
 slider 96  
 (R+PTV)

9 mm 3/8" ↑↓



**V2**  
**R10**  
 (brushed light  
 naturale)

**R10**  
**CLASSE B**  
 (flame light  
 naturale)

DCOF>  
 0,42 Wet

6 mm 1/4" ↑↓

FLOORM OVERSIZE  
**magnU**

**GRES FINE PORCELLANATO**  
 FINE PORCELAIN STONEWARE / GRÈS CÉRAME FIN / FEINSTEINZEUG-KOLLEKTIONEN / GRES PORCELÁNICO FINO  
 SQUADRATO - SQUARED - EQUARRI - REKTIFIZIERT - ESCUADRADO

| 9 mm 3/8" ↑↓    |  | COLOR         | SURFACE        | 120x120<br>47 <sup>1/4"</sup> x47 <sup>1/4"</sup> | 80x180<br>31 <sup>1/2"</sup> x70 <sup>5/8"</sup> | 60x120<br>23 <sup>5/8"</sup> x47 <sup>1/4"</sup> | 60x60<br>23 <sup>5/8"</sup> x23 <sup>5/8"</sup> |
|-----------------|--|---------------|----------------|---|--|--|---|
| <b>CORETECH</b> |  | FLAME LIGHT   | NATURALE/MATTE | -   | 778943   | 778947   | 779227  |
|                 |  |               | R+PTV          | 779553  | -  | 779555   | -   |
|                 |  |               | CANNETÉ        | -   | -  | 778953   | -   |
|                 |  | BRUSHED LIGHT | NATURALE/MATTE | -   | 778944   | 778948   | 779228  |

| 6 mm 1/4" ↑↓    |  | COLOR         | SURFACE        | 120x280<br>47 <sup>1/4"</sup> x94 <sup>1/2"</sup> | 120x240<br>47 <sup>1/4"</sup> x94 <sup>1/2"</sup> | 120x120<br>47 <sup>1/4"</sup> x47 <sup>1/4"</sup> | 60x120<br>23 <sup>5/8"</sup> x47 <sup>1/4"</sup> |
|-----------------|--|---------------|----------------|---|---|---|--|
| <b>CORETECH</b> |  | FLAME LIGHT   | NATURALE/MATTE | 778907  | 778911  | 778915  | 778919   |
|                 |  | BRUSHED LIGHT | NATURALE/MATTE | 778908  | 778912  | 778916  | 778920   |

## SATIN DARK



## FLAME DARK



**R10**  
(naturelle)  
**CLASSE B**  
(naturelle  
flame dark)

**R9**  
(soft)

**R11**  
(R+PTV)

DCOF>  
0,42 Wet

BS EN 16165  
ANNEX C  
>36 wet  
slider 96  
(R+PTV)

9 mm 3/8" ↑↓



**R10**  
(naturelle)  
**CLASSE B**  
(naturelle  
flame dark)

**R9**  
(soft)

DCOF>  
0,42 Wet

6 mm 1/4" ↑↓

FLOHM OVERSIZE  
**magnUm**

### GRES FINE PORCELLANATO







FINE PORCELAIN STONEWARE / GRÈS CÉRAME FIN / FEINSTEINZEUG-KOLLEKTIONEN / GRES PORCELÁNICO FINO  
SQUADRATO - SQUARED - EQUARRI - REKTIFIZIERT - ESCUADRADO

| 9 mm 3/8" ↑↓ | COLOR      | SURFACE        | 120x120<br>47 <sup>1/4"</sup> x47 <sup>1/4"</sup> | 80x180<br>31 <sup>1/2"</sup> x70 <sup>5/7"</sup> | 60x120<br>23 <sup>5/8"</sup> x47 <sup>1/4"</sup> | 60x60<br>23 <sup>5/8"</sup> x23 <sup>5/8"</sup> |
|--------------|------------|----------------|---|--|--|---|
| CORETECH     | SATIN DARK | SOFT           | -   | 778941   | 778945   | 779225  |
|              | FLAME DARK | NATURALE/MATTE | -   | 778942   | 778946   | 779226  |
|              |            | R+PTV          | 779552  | -  | 779554   | -   |

| 6 mm 1/4" ↑↓ | COLOR      | SURFACE        | 120x280<br>47 <sup>1/4"</sup> x94 <sup>1/2"</sup> | 120x240<br>47 <sup>1/4"</sup> x94 <sup>1/2"</sup> | 120x120<br>47 <sup>1/4"</sup> x47 <sup>1/4"</sup> | 60x120<br>23 <sup>5/8"</sup> x47 <sup>1/4"</sup> |
|--------------|------------|----------------|---|---|---|--|
| CORETECH     | SATIN DARK | SOFT           | 778905  | 778909  | 778913  | 778917   |
|              | FLAME DARK | NATURALE/MATTE | 778906  | 778910  | 778914  | 778918   |

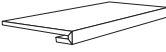
# CORETECH / ELITE

PEZZI SPECIALI/SPECIAL TRIMS/PIÈCES SPÉCIALES/FORMSTÜCKE/PIEZAS ESPECIALES

| 9 mm 3/8"  | COLOR   | SURFACE       | 4,6x120<br>1 47/50" x 4 7 1/4"  | 33x120x3<br>1 3" x 4 7 1/4" x 1 1/16"   |        |
|---|---|---------------|---|---|--------|
|   |   |               | <br>battiscopa | <br>gradino<br>pz/box 2 |        |
| <b>CORETECH</b>   |  | FLAME LIGHT   | NATURALE/MATTE  | 779586  | 779049 |
|   |  | BRUSHED LIGHT | NATURALE/MATTE  | 779585  | 779047 |
|   |  | SATIN DARK    | SOFT  | 779588  | 779050 |
|   |  | FLAME DARK    | NATURALE/MATTE  | 779587  | 779048 |

FLORIM OVERSIZE  
**magnUm**

**120x280/120x240/120x120/60x120**  
 Specifica Imballo pag.  
 Packaging specifications on page  
 Spécifications d'emballage à page  
 Verpackungsdetail Seite  
 Especificaciones de embalaje a la página  
**162/163**

Per un effetto ottimale della posa, Florim suggerisce di mantenere 2 mm di fuga per pose monoformato e 3 mm per combinare formati misti - For optimal installation results, Florim recommends maintaining a joint of 2 mm 1/12" for single format installations and 3 mm 1/8" to combine mixed formats. - Pour réaliser une pose parfait, Florim conseille de laisser 2 mm de joint pour la pose des monoformats et 3 mm pour les combinaisons de formats mixtes. - Um einen optimalen effekt beim verlegen zu erzielen empfiehlt Florim eine 2 mm fugen bei einformatigen verlegungen und 3 mm fugen bei formatkombinationen - Para lograr los máximos resultados en la posa del producto, Florim aconseja 2 mm de junta en aplicaciones monoformato y 3 mm en combinaciones de formatos mixtos.

| CORETECH | scatola - box |      |       | pallet |       |      |
|----------|---------------|------|-------|--------|-------|------|
|          | pz            | mq   | kg    | box    | mq    | kg   |
| 120x120  | 2             | 2,88 | 63,07 | 20     | 57,60 | 1340 |
| 80x180   | 2             | 2,88 | 59,33 | 20     | 57,60 | 1240 |
| 60x120   | 2             | 1,44 | 28,44 | 30     | 43,20 | 880  |
| 60x60    | 3             | 1,08 | 21,33 | 40     | 43,20 | 870  |

| CORETECH           | scatola - box |      |      | pallet |    |    |
|--------------------|---------------|------|------|--------|----|----|
|                    | pz            | ml   | kg   | box    | mq | kg |
| 4,6x120 battiscopa | 6             | 7,20 | 7,20 | -      | -  | -  |





# CORETECH OUTDOOR / ELITE

## Vantaggi tecnici - Technical advantages - Avantages techniques Technische Vorteile - Ventajas técnicas

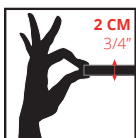

- Lastra monolitica compatta di spessore 2 cm squadrata e rettificata
- Compact monolithic slab 2 cm thick squared and rectified
- Dalle monolithique compacte de 2 cm d'épaisseur, égarrie et rectifiée
- Kompakte monolithische Platte, 2 cm dick, rechteckig und scharfkantig geschliffen
- Losa monolítica compacta de 2 cm de espesor, escuadrada y rectificada.

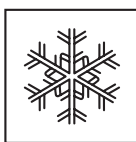

- INGELIVO
- FROST RESISTANT
- INGÉLIF
- FROSTBESTÄNDIG
- RESISTENTE A LA HELADA



- ELEVATA RESISTENZA AI CARICHI STATICI
- HIGH STATIC LOAD RESISTANCE
- RÉSISTANCE ÉLEVÉE AUX CHARGES STATIQUES
- HOHE STATISCHE BELASTBARKEIT
- ELEVADA RESISTENCIA A LAS CARGAS ESTÁTICAS



- FACILE DA POSARE
- EASY TO INSTALL
- FACILE À POSER
- VERLEGELEICHT
- FÁCIL DE COLOCAR



- ANTISCIVOLO R11
- ANTI SLIP R11
- ANTIDÉRAPANT R11
- RUTSCHFEST R11
- ANTIDESLIZANTE R11

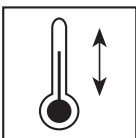

- RESISTENTE AGLI SBALZI TERMICI
- THERMAL SHOCK RESISTANT
- RÉSISTANT AUX ÉCARTS THERMIQUES
- TEMPERATURWECHSELBESTÄNDIG
- RESISTENTE A LAS OSCILACIONES TÉRMICAS



- FACILE DA PULIRE
- EASY TO CLEAN
- FACILE À NETTOYER
- REINIGUNGSLEICHT
- FÁCIL DE LIMPIAR

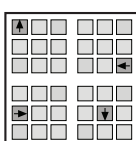

- RIMOVIBILE E RIUTILIZZABILE
- REMOVABLE AND REUSABLE
- DÉMONTABLE ET RÉUTILISABLE
- ENTFERNBAR UND WIEDERVERWENDBAR
- DESMONTABLE Y REUTILIZABLE



- INATTACCABILE DA AGENTI CHIMICI E MUFFE
- IMPERVIOUS TO ATTACK BY CHEMICALS OR MOULD
- RÉSISTANT AUX AGENTS CHIMIQUES ET AUX MOISSISSURES
- UNANGREIFBAR DURCH CHEMISCHE STOFFE UND SCHIMMEL
- RESISTENTE A LOS AGENTES QUÍMICOS Y A LOS MOHOS

## Applicazioni - Applications - Applications - Verlegung - Aplicaciones

- Posa diretta su erba
- Direct installation on grass
- Pose directe sur de l'herbe
- Verlegung direkt auf Rasen
- Colocación directa sobre hierba



- Posa diretta su ghiaia
- Direct installation over gravel
- Pose direct sur du gravier
- Verlegung direkt auf Kies
- Colocación directa sobre grava



- Posa su massetto cementizio
- Installation on sand-cement screed
- Pose sur chape ciment
- Verlegung auf Zement-Unterbetonblock
- Colocación sobre contrapiso de hormigón

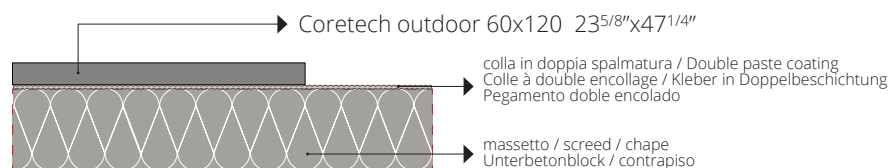

- Posa su piedini fissi o regolabili
- Installation on fixed or adjustable feet
- Pose sur pieds fixes ou réglables
- Verlegung auf feststehende oder regulierbare Füße
- Colocación sobre pies fijos o regulables

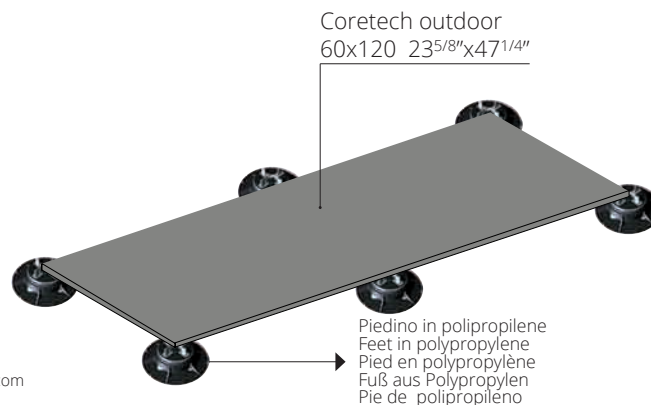

Per le specifiche di utilizzo dei sistemi sopraelevati vedi il sito florim.com  
For the specifics on use of raised systems visit the site florim.com  
Pour les caractéristiques d'utilisation des systèmes surélevés, voir le site florim.com  
Für die Nutzungsbedingungen der Doppelbodensysteme siehe Webseite florim.com  
Para las especificaciones de empleo de los sistemas sobreelevados consulte el sitio web florim.com

Le lastre ceramiche sono sottoposte a un trattamento di compattazione termica che assicura resistenza e durata nel tempo. Il bassissimo assorbimento d'acqua rende perciò il materiale ingelivo. Ciò può comportare ristagni d'acqua superficiali anche per materiale installato a regola d'arte. / Ceramic tiles undergo a compacting thermal treatment that ensures resistance and durability. The low level of water absorption makes the slabs frost resistant. This could result in superficial water stagnations even if materials are installed in a workmanlike manner. / Les carreaux de céramique subissent un traitement thermique de compactage qui assure résistance et durabilité. Le faible niveau d'absorption d'eau rend les dalles résistantes au gel. Il pourrait en résulter des stagnations d'eau superficielles, même si les dalles ont été installées dans les règles de l'art. / Die Keramikplatten werden einer thermischen Verdichtung unterzogen, welche die Widerstandsfähigkeit und Langlebigkeit sichert. Die extrem niedrige Wasseraufnahme macht das Material frostsicher. Die hohe Materialdichte kann, auch bei einer perfekten Verlegung, eine längere Abtrochnungszeit von angestaumtem Wasser zur Folge haben. / Las baldosas cerámicas se someten a un tratamiento de compactación térmica que asegura resistencia y durabilidad. La baja absorción de agua hace que las baldosas resistan al hielo. Esto podría resultar en estancamientos superficiales de agua, incluso si los materiales están instalados según las reglas del arte.



## FLAME LIGHT



V2

R11  
CLASSE C

20 mm 3/4" ↑↓

### GRES FINE PORCELLANATO

FINE PORCELAIN STONEWARE/GRES CERAME FIN/FEINSTEINZEUG-KOLLEKTIONEN/GRES PORCELANICO FINO  
SQUADRATO - SQUARED - EQUARRI - REKTIFIZIERT - ESCUADRADO

|               |       |         |  |
|---------------|-------|---------|--|
| 20 mm 3/4" ↑↓ | COLOR | SURFACE | 60x120<br>23 <sup>5/8"</sup> x47 <sup>1/4"</sup> |
|---------------|-------|---------|--|

|          |  |             |             |        |
|----------|--|-------------|-------------|--------|
| CORETECH |  | FLAME LIGHT | STRUTTURATO | 778955 |
|----------|--|-------------|-------------|--------|

|  |  |   |
|--|--|---|
|  | <b>RESISTENZA ALLA FLESSIONE IN N/mm<sup>2</sup></b><br>N/mm <sup>2</sup> FLEXURAL STRENGTH TEST / RESISTANCE<br>A LA FLEXION EN N/mm <sup>2</sup> / BIEGEFESTIGKEIT IN<br>N/mm <sup>2</sup> / RESISTENCIA A LA FLEXION EN N/mm <sup>2</sup> | <b>valore medio</b><br>52 N/mm <sup>2</sup> |
|  | <b>Forza di rottura in N (sp. &gt; 7,5 mm)</b><br>Breaking strength in N (thickness > 7,5 mm) / Force de<br>rupture en N (ep. > 7,5 mm) / Bruchlast in N (Dicke ><br>7,5 mm) / Fuerza de rotura en N (es. > 7,5 mm)                          | <b>valore medio</b><br>14000 N              |

### PEZZI SPECIALI

Special trims/Pièces spéciales/Formstücke  
Piezas especiales  
pag 152/155

| CORETECH    | scatola - box |      |       | pallet |       |     |
|-------------|---------------|------|-------|--------|-------|-----|
|             | pz            | mq   | kg    | box    | mq    | kg  |
| 60x120 20mm | 1             | 0,72 | 32,26 | 30     | 21,60 | 990 |

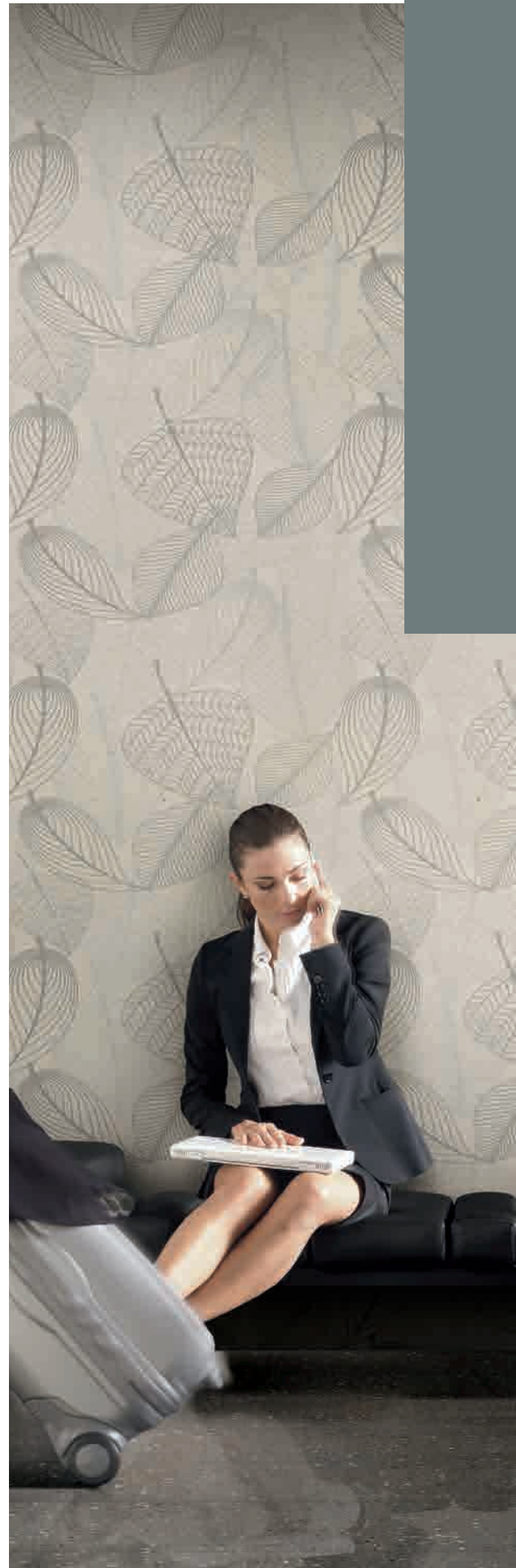

# EARTHTECH

gres fine porcellanato  
fine porcelain stoneware  
grès cérame fin  
feinsteinzeug-kollektionen  
gres porcelánico fino

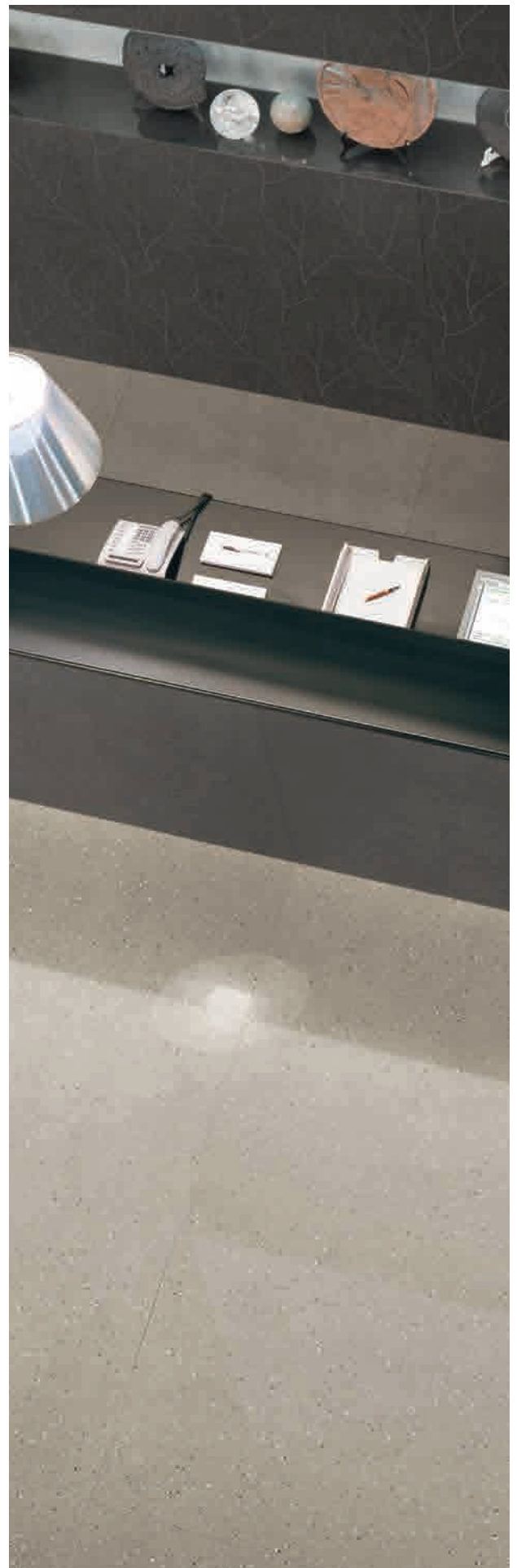





## EARTHTECH / FULL BODY

Terra e tecnologia sono divenuti un binomio sempre più reale, portatore di una nuova consapevolezza che parte dalla nostra storia per creare un futuro responsabile. **Earthtech** è la sintesi di una mentalità contemporanea, capace di essere soggetto attivo nelle regole della costruzione circolare. Un prodotto tecnico tutta massa che amalgama insieme superficie e spessore, nato dalla miscelazione spontanea di piccoli frammenti e pigmenti di diversi colori. **Sei cromie** essenziali in accordo con le sfumature degli elementi naturali caratterizzano questa serie che propone tonalità facilmente abbinabili tra loro. **Ground e Flakes** sono le due famiglie estetiche in cui si sviluppa la collezione attraverso una palette cromatica neutra e due colori intensi, giallo e arancione. Nuove finiture, comfort e glossy-bright, ne arricchiscono le possibilità di utilizzo.

Earth and technology have increasingly become a truly dual concept, bearer of a new awareness coming from our past to create a responsible future. **Earthtech** is the synthesis of a contemporary mindset, capable of being an active player within the rules of circular construction. It is a full-bodied technical product which mixes together surface and thickness, born from the spontaneous blending of small fragments and pigments of different colours. **Six essential hues** in harmony with shades of natural elements are the distinguishing features of this series which offers easily matchable tones. **Ground and Flakes** are the two aesthetic families in which the collection develops, through a neutral colour palette and two intense colours, yellow and orange. New finishes, Comfort and Glossy bright enhance their potential uses.

La terre et la technologie forment désormais un binôme de plus en plus concret, porteur d'une nouvelle prise de conscience qui part de notre histoire pour créer un futur responsable. **Earthtech** est la synthèse d'une mentalité moderne, à même de jouer un rôle actif dans les règles de la construction circulaire. Un produit technique pleine masse qui amalgame surface et épaisseur, né du mélange spontané de petits fragments et pigments de diverses couleurs. **Six colorations** essentielles en accord avec les nuances des éléments naturels caractérisent cette série qui propose des teintes pouvant facilement être combinées. **Ground et flakes** sont les deux familles esthétiques au sein desquelles se développe la collection à travers une palette chromatique neutre et deux couleurs intenses, le jaune et l'orange. De nouvelles finitions, Comfort et Glossy bright, enrichissent les possibilités d'utilisation.

Erde und Technologie wurden zu einer immer reelleren Kombination, zum Träger eines neuen Bewusstseins, das unsere Geschichte als Ausgangspunkt für die Schaffung einer verantwortungsbewussten Zukunft nimmt. **Earthtech** ergibt sich aus einer zeitgenössischen Mentalität, die bei den Regeln zur Kreislaufbauwirtschaft eine aktive Rolle spielt. Ein ganzscherbiges technisches Produkt, das Oberfläche und Masse vermischt und aus der spontanen Mischung kleiner Fragmente und verschiedenfarbiger Pigmente entsteht. **Sechs Farben** widerspiegeln die Nuancen der Naturelemente und zeichnen diese Serie mit ihren untereinander leicht kombinierbaren Farbtönen aus. **Ground und Flakes** sind zwei ästhetische Varianten, in denen sich die Kollektion durch eine neutrale Farbpalette und zwei intensive Farben, gelb und orange, entwickelt. Neue Oberflächen, Comfort und Glossy-Bright, vervielfältigen ihre Einsatzmöglichkeiten.

La tierra y la tecnología se han convertido en un binomio cada vez más real, portador de una nueva sensibilidad que echa raíces en nuestra historia para crear un futuro responsable. **Earthtech** es la síntesis de una forma de pensar contemporánea, capaz de participar activamente en la economía circular del sector de la construcción. Un producto técnico toda masa que conjuga superficie y grosor, fruto de la mezcla espontánea de pequeños fragmentos y pigmentos de varios colores. **Seis colores** básicos, acordes con los matices cromáticos de los elementos naturales, componen esta serie caracterizada por tonalidades fáciles de combinar entre sí. **Ground y flakes** son las dos familias estéticas en las que se articula la colección, por medio de una paleta cromática neutra y dos colores intensos: el amarillo y el naranja. Se enriquece con los nuevos acabados Comfort y Glossy-bright, que amplían sus posibilidades de uso.



# EARTHTECH / FULL BODY

## PUMICE\_GROUND



## PUMICE\_FLAKES



**R10**  
**Classe B**  
(comfort)

DCOF>  
0,60 Wet  
(comfort)

BS EN 16165  
ANNEX C  
>36 wet  
slider 96  
(comfort)

9 mm 3/8" ↑↓

**R10**  
**Classe B**

DCOF>  
0,60 Wet

BS EN 16165  
ANNEX C  
>36 wet  
slider 96  
(comfort)

6 mm 1/4" ↑↓



**GRES FINE PORCELLANATO**  
FINE PORCELAIN STONEWARE / GRÈS CÉRAME FIN / FEINSTEINZEUG-KOLLEKTIONEN / GRES PORCELÁNICO FINO  
SQUADRATO - SQUARED - EQUARRI - REKTIFIZIERT - ESCUADRADO

| 9 mm 3/8" ↑↓     |               | COLOR         | SURFACE | 120x240<br>47 <sup>1/4"</sup> x94 <sup>1/2"</sup> | 120x120<br>47 <sup>1/4"</sup> x47 <sup>1/4"</sup> | 60x120<br>23 <sup>5/8"</sup> x47 <sup>1/4"</sup> | 60x60*<br>23 <sup>5/8"</sup> x23 <sup>5/8"</sup> |
|------------------|---------------|---------------|---------|---|---|--|--|
| <b>EARTHTECH</b> | PUMICE_GROUND | COMFORT       | -       | 777189  | 776958  | 776977   |  |
|                  | PUMICE_FLAKES | COMFORT       | 776929  | 776941  | 776960  | 776979   |  |
|                  |               | GLOSSY-BRIGHT | 776923  | 776935  | 776947  | 776967   |  |

| 6 mm 1/4" ↑↓     |               | COLOR   | SURFACE | 120x280<br>47 <sup>1/4"</sup> x110 <sup>1/4"</sup> | 120x240<br>47 <sup>1/4"</sup> x94 <sup>1/2"</sup> | 120x120<br>47 <sup>1/4"</sup> x47 <sup>1/4"</sup> | 60x120<br>23 <sup>5/8"</sup> x47 <sup>1/4"</sup> |
|------------------|---------------|---------|---------|--|---|---|--|
| <b>EARTHTECH</b> | PUMICE_GROUND | COMFORT | 771449  | 771459   | 771607  | 771631  |  |

**60x60\***  
solo su richiesta per ordini >1.000 mq  
only upon request for orders > 1.000 sqm  
uniquement sur demande pour les commandes >1.000 m<sup>2</sup>  
nur auf Anfrage für Bestellungen >1.000 m<sup>2</sup>  
solo a petición para pedidos >1.000 m<sup>2</sup>

## DESERT\_GROUND



## DESERT\_FLAKES



**R10**  
**Classe B**  
(comfort)

DCOF>  
0,60 Wet  
(comfort)

BS EN 16165  
ANNEX C  
>36 wet  
slider 96  
(comfort)

**9 mm** 3/8" ↑↓

**R10**  
**Classe B**



DCOF>  
0,60 Wet

BS EN 16165  
ANNEX C  
>36 wet  
slider 96  
(comfort)

**6 mm** 1/4" ↑↓

FLORIM OVERSIZE  
**magnUm**

**GRES FINE PORCELLANATO**  
FINE PORCELAIN STONEWARE / GRÈS CÉRAME FIN / FEINSTEINZEUG-KOLLEKTIONEN / GRES PORCELÁNICO FINO  
SQUADRATO - SQUARED - EQUARRI - REKTIFIZIERT - ESCUADRADO

| <b>9 mm</b> 3/8" ↑↓ |   | COLOR         | SURFACE       | <b>120x240</b><br>47 <sup>1/4"</sup> x94 <sup>1/2"</sup>  | <b>120x120</b><br>47 <sup>1/4"</sup> x47 <sup>1/4"</sup> | <b>60x120</b><br>23 <sup>5/8"</sup> x47 <sup>1/4"</sup>  | <b>60x60*</b><br>23 <sup>5/8"</sup> x23 <sup>5/8"</sup> |
|---------------------|---|---------------|---------------|---|--|--|---|
| <b>EARTHTECH</b>    |  | DESERT_GROUND | COMFORT       | -   | 777184   | 776953   | 776972  |
|                     |  | DESERT_FLAKES | COMFORT       | 776932  | 776944   | 776963   | 776982  |
|                     |   |               | GLOSSY-BRIGHT | 776926  | 776938   | 776951   | 776970  |
| <b>6 mm</b> 1/4" ↑↓ |   | COLOR         | SURFACE       | <b>120x280</b><br>47 <sup>1/4"</sup> x110 <sup>1/4"</sup> | <b>120x240</b><br>47 <sup>1/4"</sup> x94 <sup>1/2"</sup> | <b>120x120</b><br>47 <sup>1/4"</sup> x47 <sup>1/4"</sup> | <b>60x120</b><br>23 <sup>5/8"</sup> x47 <sup>1/4"</sup> |
| <b>EARTHTECH</b>    |  | DESERT_GROUND | COMFORT       | 771450  | 771462   | 771626   | 771632  |

# EARTHTECH / FULL BODY

## FOG\_GROUND



## FOG\_FLAKES

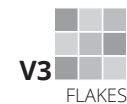

**R10**  
**Classe B**  
(comfort)

DCOF>  
0,60 Wet  
(comfort)

BS EN 16165  
ANNEX C  
>36 wet  
slider 96  
(comfort)

9 mm 3/8" ↑↓

**R10**  
**Classe B**

DCOF>  
0,60 Wet

BS EN 16165  
ANNEX C  
>36 wet  
slider 96  
(comfort)

6 mm 1/4" ↑↓

FLOHM OVERSIZE  
**magnum**

**GRES FINE PORCELLANATO**  
FINE PORCELAIN STONEWARE / GRÈS CÉRAME FIN / FEINSTEINZEUG-KOLLEKTIONEN / GRES PORCELÁNICO FINO  
SQUADRATO - SQUARED - EQUARRI - REKTIFIZIERT - ESCUADRADO

| 9 mm 3/8" ↑↓     |  | COLOR      | SURFACE       | 120x240<br>47 <sup>1/4"</sup> x94 <sup>1/2"</sup> | 120x120<br>47 <sup>1/4"</sup> x47 <sup>1/4"</sup> | 60x120<br>23 <sup>5/8"</sup> x47 <sup>1/4"</sup> | 60x60*<br>23 <sup>5/8"</sup> x23 <sup>5/8"</sup> |
|------------------|--|------------|---------------|---|---|--|--|
| <b>EARTHTECH</b> |  | FOG_GROUND | COMFORT       | -   | 777185  | 776954   | 776973   |
|                  |  | FOG_FLAKES | COMFORT       | 776931  | 776943  | 776962   | 776981   |
|                  |  |            | GLOSSY-BRIGHT | 776925  | 776937  | 776949   | 776969   |

| 6 mm 1/4" ↑↓     |  | COLOR      | SURFACE | 120x280<br>47 <sup>1/4"</sup> x110 <sup>1/4"</sup> | 120x240<br>47 <sup>1/4"</sup> x94 <sup>1/2"</sup> | 120x120<br>47 <sup>1/4"</sup> x47 <sup>1/4"</sup> | 60x120<br>23 <sup>5/8"</sup> x47 <sup>1/4"</sup> |
|------------------|--|------------|---------|--|---|---|--|
| <b>EARTHTECH</b> |  | FOG_GROUND | COMFORT | 771451   | 771463  | 771627  | 771633   |

**60x60\***  
solo su richiesta per ordini >1.000 mq  
only upon request for orders > 1.000 sqm  
uniquement sur demande pour les commandes >1.000 m<sup>2</sup>  
nur auf Anfrage für Bestellungen >1.000 m<sup>2</sup>  
solo a petición para pedidos >1.000 m<sup>2</sup>



## CARBON\_GROUND

## CARBON\_FLAKES

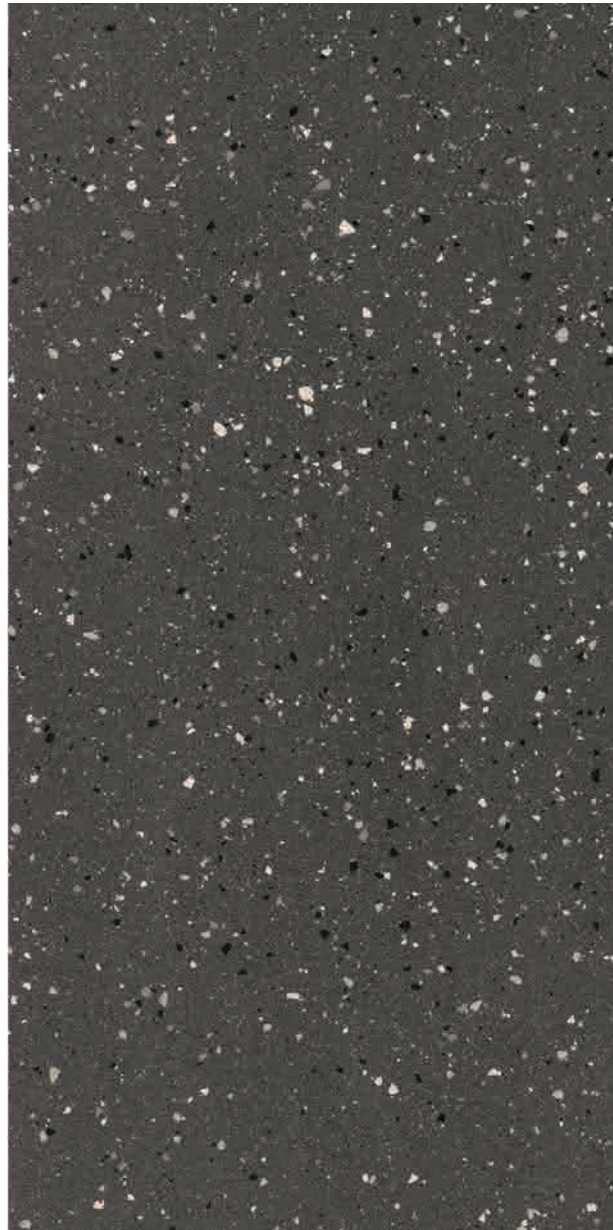

**R10**  
**Classe B**  
(comfort)

DCOF>  
0,60 Wet  
(comfort)

BS EN 16165  
ANNEX C  
>36 wet  
slider 96  
(comfort)

9 mm 3/8" ↑↓

**R10**  
**Classe B**



DCOF>  
0,60 Wet

BS EN 16165  
ANNEX C  
>36 wet  
slider 96  
(comfort)

6 mm 1/4" ↑↓

FLORIM OVERSIZE  
**magnlum**

**GRES FINE PORCELLANATO**  
FINE PORCELAIN STONEWARE / GRÈS CÉRAME FIN / FEINSTEINZEUG-KOLLEKTIONEN / GRES PORCELÁNICO FINO  
SQUADRATO - SQUARED - EQUARRI - REKTIFIZIERT - ESCUADRADO

| 9 mm 3/8" ↑↓     |   | COLOR         | SURFACE       | 120x240<br>47 <sup>1/4"</sup> x94 <sup>1/2"</sup> | 120x120<br>47 <sup>1/4"</sup> x47 <sup>1/4"</sup> | 60x120<br>23 <sup>5/8"</sup> x47 <sup>1/4"</sup> | 60x60*<br>23 <sup>5/8"</sup> x23 <sup>5/8"</sup> |
|------------------|---|---------------|---------------|---|---|--|--|
| <b>EARTHTECH</b> |  | CARBON_GROUND | COMFORT       | -   | 777186  | 776955   | 776974   |
|                  |  | CARBON_FLAKES | COMFORT       | 776933  | 776945  | 776965   | 776983   |
|                  |   |               | GLOSSY-BRIGHT | 776927  | 776939  | 776952   | 776971   |

| 6 mm 1/4" ↑↓     |   | COLOR         | SURFACE | 120x280<br>47 <sup>1/4"</sup> x110 <sup>1/4"</sup> | 120x240<br>47 <sup>1/4"</sup> x94 <sup>1/2"</sup> | 120x120<br>47 <sup>1/4"</sup> x47 <sup>1/4"</sup> | 60x120<br>23 <sup>5/8"</sup> x47 <sup>1/4"</sup> |
|------------------|---|---------------|---------|--|---|---|--|
| <b>EARTHTECH</b> |  | CARBON_GROUND | COMFORT | 771452   | 771464  | 771628  | 771634   |

# EARTHTECH / FULL BODY

## SAVANNAH\_GROUND



## SAVANNAH\_FLAKES



**R10**  
**Classe B**  
(comfort)

DCOF>  
0,60 Wet  
(comfort)

BS EN 16165  
ANNEX C  
>36 wet  
slider 96  
(comfort)

**9 mm** 3/8" ↑↓

**R10**  
**Classe B**



DCOF>  
0,60 Wet

BS EN 16165  
ANNEX C  
>36 wet  
slider 96  
(comfort)

**6 mm** 1/4" ↑↓

FLOHM OVERSIZE  
**magnum**

**GRES FINE PORCELLANATO**  
FINE PORCELAIN STONEWARE / GRÈS CÉRAMÉ FIN / FEINSTEINZEUG-KOLLEKTIONEN / GRES PORCELÁNICO FINO  
SQUADRATO - SQUARED - EQUARRI - REKTIFIZIERT - ESCUADRADO

| <b>9 mm</b> 3/8" ↑↓ |   | COLOR           | SURFACE       | <b>120x240</b><br>47 <sup>1/4"</sup> x94 <sup>1/2"</sup> | <b>120x120</b><br>47 <sup>1/4"</sup> x47 <sup>1/4"</sup> | <b>60x120</b><br>23 <sup>5/8"</sup> x47 <sup>1/4"</sup> | <b>60x60*</b><br>23 <sup>5/8"</sup> x23 <sup>5/8"</sup> |
|---------------------|---|-----------------|---------------|--|--|---|---|
| <b>EARTHTECH</b>    |  | SAVANNAH_GROUND | COMFORT       | -  | 777187   | 776956  | 776975  |
|                     |  | SAVANNAH_FLAKES | COMFORT       | 776928   | 776940   | 776959  | 776978  |
|                     |   |                 | GLOSSY-BRIGHT | 776922   | 776934   | 776946  | 776966  |

| <b>6 mm</b> 1/4" ↑↓ |   | COLOR           | SURFACE | <b>120x280</b><br>47 <sup>1/4"</sup> x110 <sup>1/4"</sup> | <b>120x240</b><br>47 <sup>1/4"</sup> x94 <sup>1/2"</sup> | <b>120x120</b><br>47 <sup>1/4"</sup> x47 <sup>1/4"</sup> | <b>60x120</b><br>23 <sup>5/8"</sup> x47 <sup>1/4"</sup> |
|---------------------|---|-----------------|---------|---|--|--|---|
| <b>EARTHTECH</b>    |  | SAVANNAH_GROUND | COMFORT | 771453  | 771465   | 771629   | 771635  |

**60x60\***

solo su richiesta per ordini >1.000 mq  
only upon request for orders > 1.000 sqm  
uniquement sur demande pour les commandes >1.000 m<sup>2</sup>  
nur auf Anfrage für Bestellungen >1.000 m<sup>2</sup>  
solo a petición para pedidos >1.000 m<sup>2</sup>



## OUTBACK\_GROUND



## OUTBACK\_FLAKES

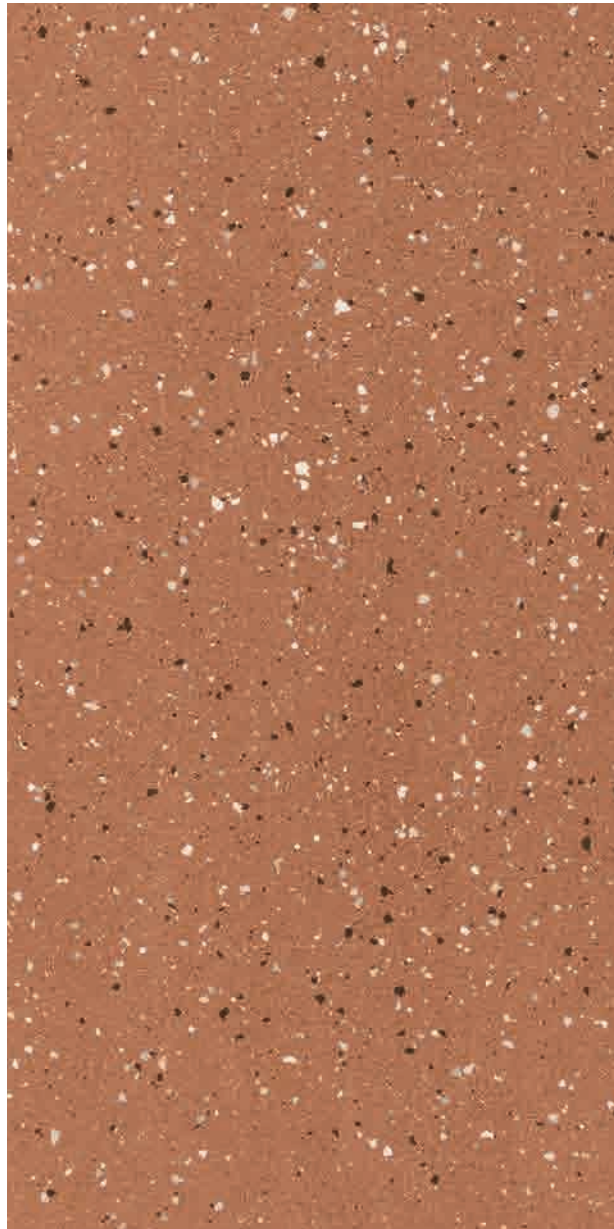

**R10**  
**Classe B**  
(comfort)

DCOF>  
0,60 Wet  
(comfort)

BS EN 16165  
ANNEX C  
>36 wet  
slider 96  
(comfort)

9 mm 3/8" ↑↓

**R10**  
**Classe B**



DCOF>  
0,60 Wet

BS EN 16165  
ANNEX C  
>36 wet  
slider 96  
(comfort)

6 mm 1/4" ↑↓

FLORIM OVERSIZE  
**magnum**

**GRES FINE PORCELLANATO**  
FINE PORCELAIN STONEWARE / GRÈS CÉRAME FIN / FEINSTEINZEUG-KOLLEKTIONEN / GRES PORCELÁNICO FINO  
SQUADRATO - SQUARED - EQUARRI - REKTIFIZIERT - ESCUADRADO

| 9 mm 3/8" ↑↓     | COLOR   | SURFACE        | 120x240<br>47 <sup>1/4"</sup> x94 <sup>1/2"</sup>  | 120x120<br>47 <sup>1/4"</sup> x47 <sup>1/4"</sup> | 60x120<br>23 <sup>5/8"</sup> x47 <sup>1/4"</sup>  | 60x60*<br>23 <sup>5/8"</sup> x23 <sup>5/8"</sup> |        |
|------------------|---|----------------|--|---|---|--|--------|
| <b>EARTHTECH</b> |  | OUTBACK_GROUND | COMFORT  | -   | 777188  | 776957   | 776976 |
|                  |   | OUTBACK_FLAKES | COMFORT  | 776930  | 776942  | 776961   | 776980 |
|                  | GLOSSY-BRIGHT   |                | 776924   | 776936  | 776948  | 776968   |        |
| 6 mm 1/4" ↑↓     | COLOR   | SURFACE        | 120x280<br>47 <sup>1/4"</sup> x110 <sup>1/4"</sup> | 120x240<br>47 <sup>1/4"</sup> x94 <sup>1/2"</sup> | 120x120<br>47 <sup>1/4"</sup> x47 <sup>1/4"</sup> | 60x120<br>23 <sup>5/8"</sup> x47 <sup>1/4"</sup> |        |
| <b>EARTHTECH</b> |  | OUTBACK_GROUND | COMFORT  | 771454  | 771466  | 771630   | 771636 |

# EARTHTECH / FULL BODY

## PUMICE

## DESERT

## FOG



Il decoro FRONDS\_A è disponibile a magazzino nel colore CARBON GROUND nei seguenti formati 120x280, 120x240 e 60x120.

The FRONDS\_A décor is available in stock in the colour CARBON GROUND in the sizes 120x280, 120x240 and 60x120. / Le Décor FRONDS\_A est disponible en stock dans la couleur CARBON GROUND dans les formats 120x280, 120x240 e 60x120. / Der Dekor FRONDS\_A ist in der Farbe CARBON GROUND in den folgenden Formaten 120x280, 120x240 und 60x120 als Lagerware bestellbar. / La decoración FRONDS\_A está disponible en stock en el color CARBON GROUND en los siguientes formatos 120x280, 120x240 y 60x120.

### GRES FINE PORCELLANATO

FINE PORCELAIN STONEWARE / GRÈS CÉRAME FIN / FEINSTEINZEUG-KOLLEKTIONEN / GRES PORCELÁNICO FINO  
SQUADRATO - SQUARED - EQUARRI - REKTIFIZIERT - ESCUADRADO

FLORIM OVERSIZE  
**magnUm**

| 6 mm 1/4" ↑↓     | COLOR                    | SURFACE | 120x280                                 | 120x240                                | 60x120                                 |
|------------------|--------------------------|---------|---|--|--|
|                  |                          |         | 47 <sup>1/4"</sup> x110 <sup>1/4"</sup> | 47 <sup>1/4"</sup> x94 <sup>1/2"</sup> | 23 <sup>5/8"</sup> x47 <sup>1/4"</sup> |
| <b>EARTHTECH</b> | FRONDS_A_CARBON_GROUND   | COMFORT | 772725                                  | 772731                                 | -                                      |
|                  | FRONDS_A_CARBON_GROUND_1 | COMFORT | -                                       | -                                      | 772737                                 |
|                  | FRONDS_A_CARBON_GROUND_2 | COMFORT | -                                       | -                                      | 772738                                 |
|                  | FRONDS_A_CARBON_GROUND_3 | COMFORT | -                                       | -                                      | 772739                                 |
|                  | FRONDS_A_CARBON_GROUND_4 | COMFORT | -                                       | -                                      | 772740                                 |

CARBON

SAVANNAH

OUTBACK



## DECORO FRONDS\_A

### GRES FINE PORCELLANATO

FINE PORCELAIN STONEWARE / GRÈS CÉRAME FIN / FEINSTEINZEUG-KOLLEKTIONEN / GRES PORCELÁNICO FINO  
SQUADRATO - SQUARED - EQUARRI - REKTIFIZIERT - ESCUADRADO

FLOHM OVERSIZE  
**magnUm**

| 6 mm 1/4" ↑↓     | COLOR             | SURFACE | 120x280                                 | 120x240                                | 60x120                                 |
|------------------|-------------------|---------|---|--|--|
|                  |                   |         | 47 <sup>1/4"</sup> x110 <sup>1/4"</sup> | 47 <sup>1/4"</sup> x94 <sup>1/2"</sup> | 23 <sup>5/8"</sup> x47 <sup>1/4"</sup> |
|                  | FRONDS_A_GROUND   | COMFORT | 772726                                  | 772732                                 | -                                      |
| <b>EARTHTECH</b> | FRONDS_A_GROUND_1 | COMFORT | -                                       | -                                      | 772741                                 |
|                  | FRONDS_A_GROUND_2 | COMFORT | -                                       | -                                      | 772742                                 |
|                  | FRONDS_A_GROUND_3 | COMFORT | -                                       | -                                      | 772743                                 |
|                  | FRONDS_A_GROUND_4 | COMFORT | -                                       | -                                      | 772744                                 |

**I restanti colori sono ordinabili su richiesta tramite i codici on demand della tabella a fianco, specificando il colore desiderato.**

The remaining colours can be ordered on request using the "on demand" codes in the opposite table, specifying the desired colour. / Les autres couleurs peuvent être commandées sur demande avec les codes spécifiques du tableau en pièce jointe, en indiquant la couleur souhaitée. / Die restlichen Farben können auf Anfrage unter Verwendung der "On-Demand-Codes" in der nebenstehenden Tabelle unter Angabe der gewünschten Farbe bestellt werden. / El resto de colores se pueden pedir a través de los códigos de la tabla, eligiendo colores y acabados como desee.

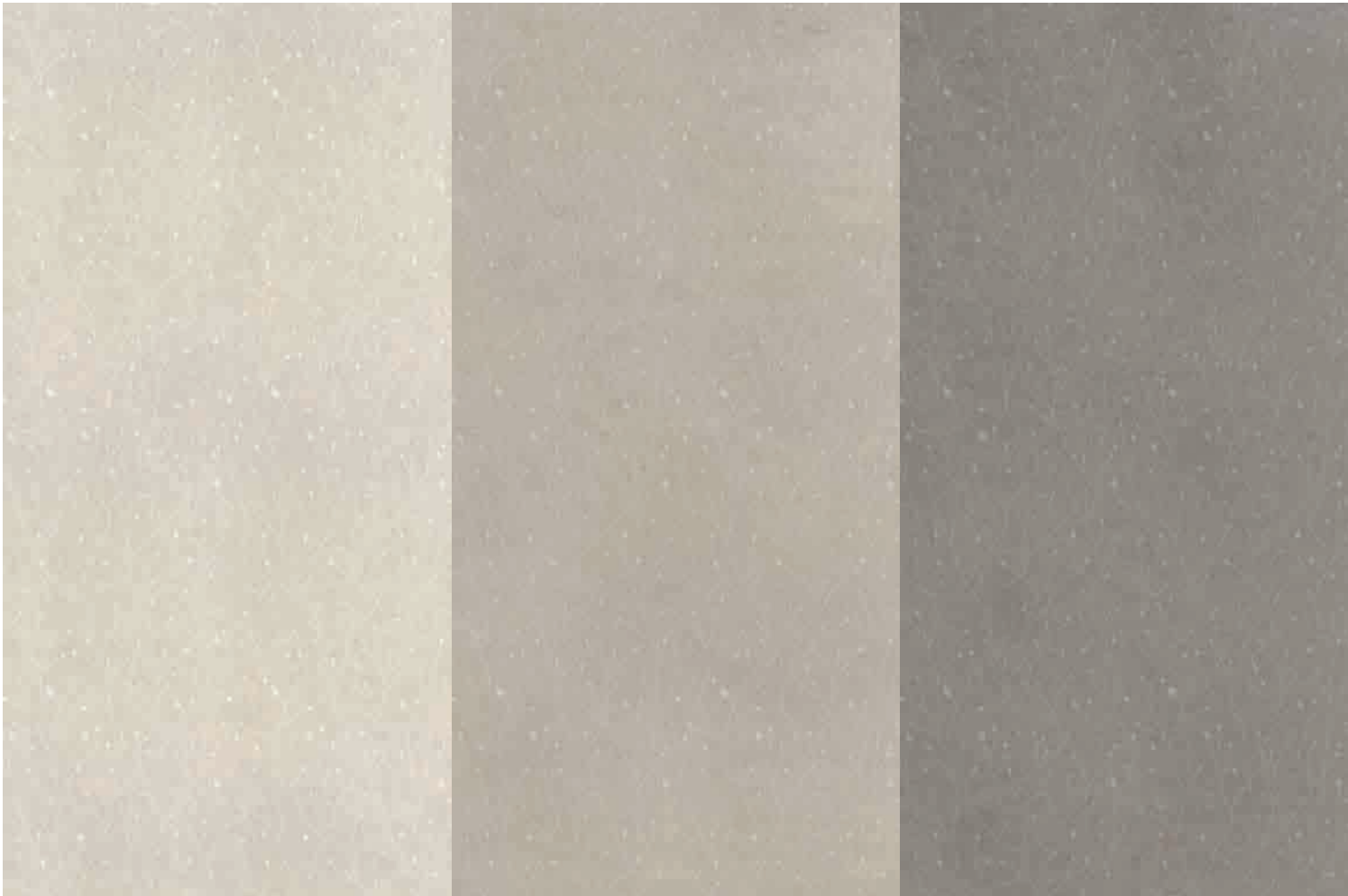

FLOORM OVERSIZE  
**magnUm**

|                  |                          |         | <b>120x280</b><br>47 <sup>1/4"</sup> x110 <sup>1/4"</sup> | <b>120x240</b><br>47 <sup>1/4"</sup> x94 <sup>1/2"</sup> | <b>60x120</b><br>23 <sup>5/8"</sup> x47 <sup>1/4"</sup> |
|------------------|--------------------------|---------|---|--|---|
|                  | COLOR                    | SURFACE |   |  |   |
|                  | FRONDS_B_DESERT_GROUND   | COMFORT | 772727  | 772733   | -   |
| <b>EARTHTECH</b> | FRONDS_B_DESERT_GROUND_1 | COMFORT | -   | -  | 772745  |
|                  | FRONDS_B_DESERT_GROUND_2 | COMFORT | -   | -  | 772746  |
|                  | FRONDS_B_DESERT_GROUND_3 | COMFORT | -   | -  | 772747  |
|                  | FRONDS_B_DESERT_GROUND_4 | COMFORT | -   | -  | 772748  |

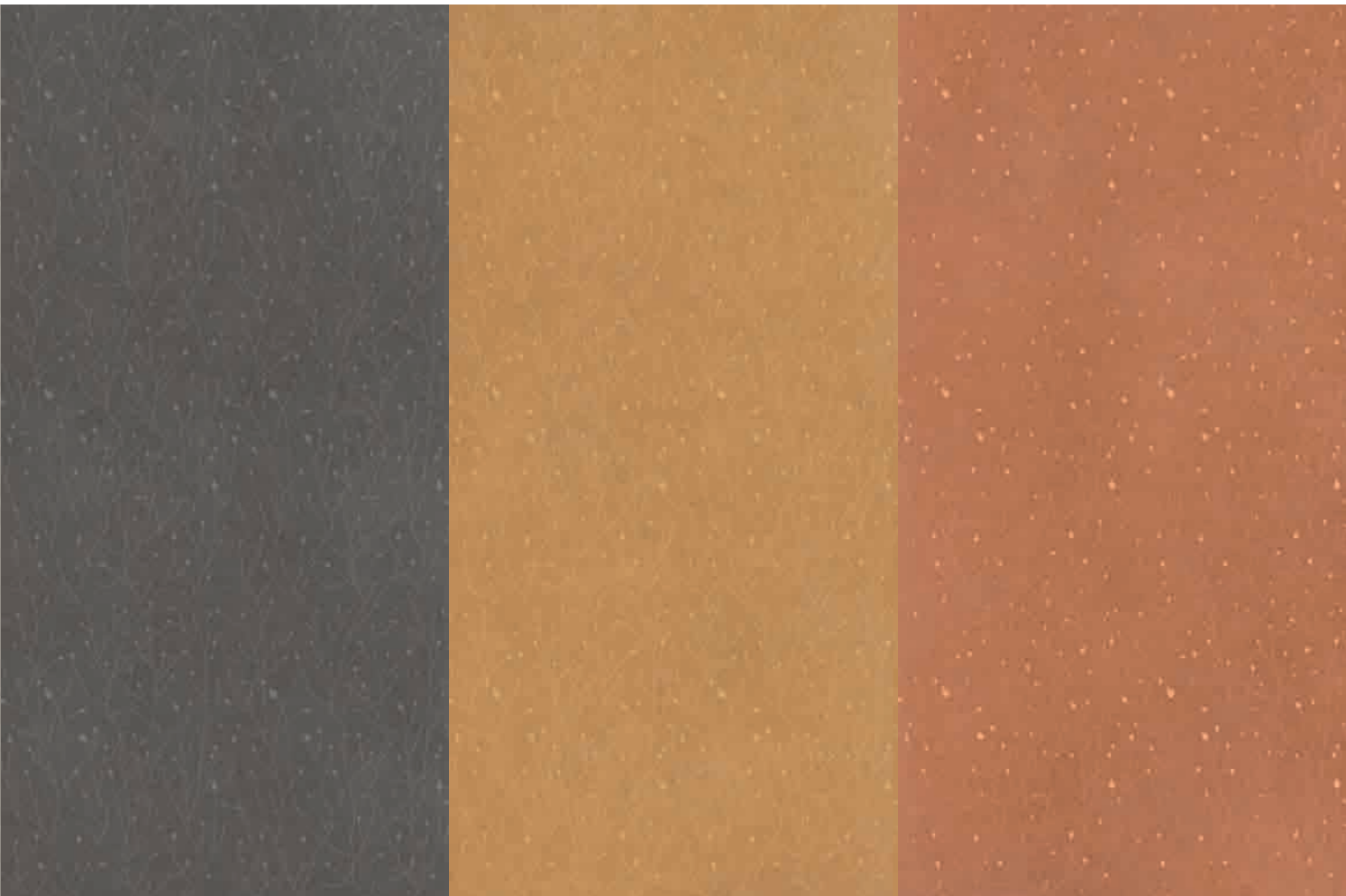

FLOHM OVERSIZE  
magnum





FLOORM OVERSIZE  
**magnUm**

|                  | COLOR                  | SURFACE | 120x280                                 | 120x240                                | 60x120                                 |
|------------------|------------------------|---------|---|--|--|
|                  |                        |         | 47 <sup>1/4"</sup> x110 <sup>1/4"</sup> | 47 <sup>1/4"</sup> x94 <sup>1/2"</sup> | 23 <sup>5/8"</sup> x47 <sup>1/4"</sup> |
|                  | LEAVES_PUMICE_GROUND   | COMFORT | 772729                                  | 772735                                 | -                                      |
| <b>EARTHTECH</b> | LEAVES_PUMICE_GROUND_1 | COMFORT | -                                       | -                                      | 772753                                 |
|                  | LEAVES_PUMICE_GROUND_2 | COMFORT | -                                       | -                                      | 772754                                 |
|                  | LEAVES_PUMICE_GROUND_3 | COMFORT | -                                       | -                                      | 772755                                 |
|                  | LEAVES_PUMICE_GROUND_4 | COMFORT | -                                       | -                                      | 772756                                 |

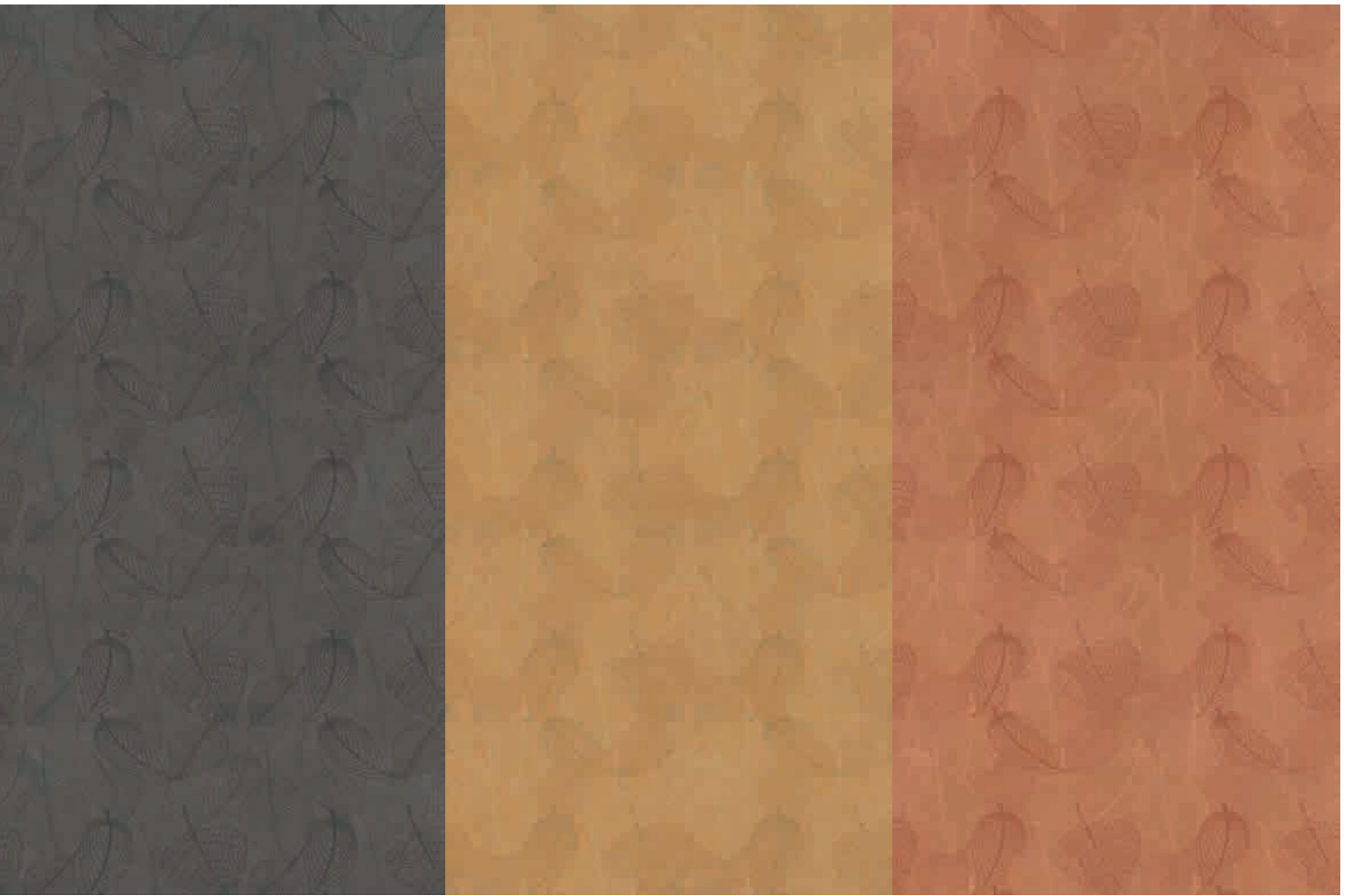







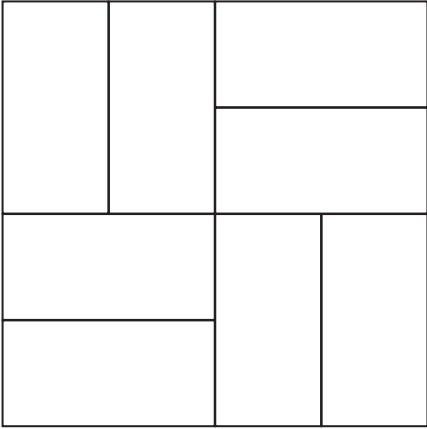





FLOHM OVERSIZE  
magnum







# EARTHTECH / FULL BODY

|   | COLOR   | SURFACE         | 30x30<br>11 4/5" x 11 4/5"          | 21x40<br>8 1/4" x 15 3/4"   |        |
|---|---|-----------------|-------------------------------------|-----------------------------|--------|
|   |   |                 | mosaico<br>tessere 3x3<br>pz/box 11 | modulo listello<br>sfalsato |        |
| <b>EARTHTECH</b>  |    | PUMICE_GROUND   | COMFORT                             | 772393                      | 772417 |
|   |    | PUMICE_FLAKES   | COMFORT                             | 772399                      | 772423 |
|   |   |                 | GLOSSY-BRIGHT                       | 772435                      | 772429 |
|   |    | DESERT_GROUND   | COMFORT                             | 772394                      | 772418 |
|   |    | DESERT_FLAKES   | COMFORT                             | 772400                      | 772424 |
|   |   |                 | GLOSSY-BRIGHT                       | 772436                      | 772430 |
|   |    | FOG_GROUND      | COMFORT                             | 772395                      | 772419 |
|   |    | FOG_FLAKES      | COMFORT                             | 772401                      | 772425 |
|   |   |                 | GLOSSY-BRIGHT                       | 772437                      | 772431 |
|   |   | CARBON_GROUND   | COMFORT                             | 772396                      | 772420 |
|   |  | CARBON_FLAKES   | COMFORT                             | 772402                      | 772426 |
|   |   |                 | GLOSSY-BRIGHT                       | 772438                      | 772432 |
|   |  | SAVANNAH_GROUND | COMFORT                             | 772397                      | 772421 |
|   |  | SAVANNAH_FLAKES | COMFORT                             | 772403                      | 772427 |
|   |   |                 | GLOSSY-BRIGHT                       | 772439                      | 772433 |
|   |  | OUTBACK_GROUND  | COMFORT                             | 772398                      | 772422 |
|  | OUTBACK_FLAKES  | COMFORT         | 772404                              | 772428                      |        |
|   |   | GLOSSY-BRIGHT   | 772440                              | 772434                      |        |











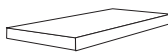

| EARTHTECH                 | scatola - box |      |       | pallet |       |     |
|---------------------------|---------------|------|-------|--------|-------|-----|
|                           | pz            | mq   | kg    | box    | mq    | kg  |
| 60x60                     | 3             | 1,08 | 23,65 | 40     | 43,20 | 970 |
| 60x120                    | 2             | 1,44 | 31,54 | 30     | 43,20 | 970 |
| 21x40 mod. list. sfalsato | 5             | 0,42 | 9,66  | 40     | 16,80 | 420 |

| EARTHTECH         | scatola - box |      |      | pallet |    |    |
|-------------------|---------------|------|------|--------|----|----|
|                   | pz            | ml   | kg   | box    | mq | kg |
| 4,6x60 battiscopa | 14            | 8,40 | 8,40 | -      | -  | -  |









PEZZI SPECIALI/SPECIAL TRIMS/PIÈCES SPÉCIALES/FORMSTÜCKE/PIEZAS ESPECIALES

9 mm 3/8" 

|   | COLOR   | SURFACE         | <b>4,6x60</b><br>1 4/5" x 2 3/8"<br><br>battiscopa | <b>33x120x3</b><br>1 3/8" x 4 7/8" x 1 1/8"<br><br>angolo gradino DX<br>pz/box 2 | <b>33x120x3</b><br>1 3/8" x 4 7/8" x 1 1/8"<br><br>gradino<br>pz/box 2 | <b>33x120x3</b><br>1 3/8" x 4 7/8" x 1 1/8"<br><br>angolo gradino SX<br>pz/box 2 |        |
|---|---|-----------------|---|--|---|---|--------|
| <b>EARTHTECH</b>  |    | PUMICE_GROUND   | COMFORT   | 772441   | 772485  | 772466  | 772491 |
|   |    | PUMICE_FLAKES   | COMFORT   | 772447   | 772499  | 772472  | 772505 |
|   |   |                 | GLOSSY-BRIGHT   | 772453   | 772511  | 772478  | 772517 |
|   |    | DESERT_GROUND   | COMFORT   | 772442   | 772486  | 772467  | 772492 |
|   |    | DESERT_FLAKES   | COMFORT   | 780286   | 772500  | 772473  | 772506 |
|   |   |                 | GLOSSY-BRIGHT   | 780287   | 772512  | 772479  | 772518 |
|   |    | FOG_GROUND      | COMFORT   | 772443   | 772487  | 772468  | 772493 |
|   |    | FOG_FLAKES      | COMFORT   | 772449   | 772501  | 772474  | 772507 |
|   |   |                 | GLOSSY-BRIGHT   | 780288   | 772513  | 772480  | 772519 |
|   |   | CARBON_GROUND   | COMFORT   | 772444   | 772488  | 772469  | 772494 |
|   |  | CARBON_FLAKES   | COMFORT   | 772450   | 772502  | 772475  | 772508 |
|   |   |                 | GLOSSY-BRIGHT   | 772456   | 772514  | 772481  | 772520 |
|   |  | SAVANNAH_GROUND | COMFORT   | 772445   | 772489  | 772470  | 772496 |
|   |  | SAVANNAH_FLAKES | COMFORT   | 772451   | 772503  | 772476  | 772509 |
|   |   |                 | GLOSSY-BRIGHT   | 780289   | 772515  | 772482  | 772521 |
|   |  | OUTBACK_GROUND  | COMFORT   | 772446   | 772490  | 772471  | 772497 |
|  | OUTBACK_FLAKES  | COMFORT         | 772452  | 772504   | 772477  | 772510  |        |
|   |   | GLOSSY-BRIGHT   | 772458  | 772516   | 772483  | 772522  |        |

# EARTHTECH / FULL BODY

|   |   | PEZZI SPECIALI/SPECIAL TRIMS<br>PIÈCES SPÉCIALES/FORMSTÜCKE<br>PIEZAS ESPECIALES |         |  |  |   |
|---|---|--|---------|--|--|---|
| 6 mm 1/4"  |   |  |         | 30x30<br>11 4/5"x11 4/5"<br><br>mosaico<br>tessere 7,5x7,5<br>pz/box 11 | 30x30<br>11 4/5"x11 4/5"<br><br>muretto<br>tessere 7,5x15<br>pz/box 11 | 4,6x60<br>1 4/5"x23 5/8"<br><br>battiscopa |
|   | COLOR   | SURFACE  |         |  |  |   |
| EARTHTECH   |  | PUMICE_GROUND  | COMFORT | 772405   | 772523   | 772459  |
|   |  | DESERT_GROUND  | COMFORT | 772406   | 772524   | 772460  |
|   |  | FOG_GROUND   | COMFORT | 772407   | 772525   | 772461  |
|   |  | CARBON_GROUND  | COMFORT | 772408   | 772526   | 772462  |
|   |  | SAVANNAH_GROUND  | COMFORT | 772409   | 772527   | 772463  |
|   |  | OUTBACK_GROUND   | COMFORT | 772410   | 772528   | 772464  |

FLORM OVERSIZE  
**magnUm**

120x280/120x240/120x120/60x120

Specifica Imballo pag.  
Packaging specifications on page  
Spécifications d'emballage à page  
Verpackungsdetail Seite  
Especificaciones de embalaje a la página  
**162/163**

**Per un effetto ottimale della posa, Florim suggerisce di mantenere 2 mm di fuga per pose monoformato e 3 mm per combinare formati misti** - For optimal installation results, Florim recommends maintaining a joint of 2 mm 1/16" for single format installations and 3 mm 1/8" to combine mixed formats. - Pour réaliser une pose parfait, Florim conseille de laisser 2 mm de joint pour la pose des monoformats et 3 mm pour les combinaisons de formats mixtes. - Um einen optimalen effekt beim verlegen zu erzielen empfiehlt Florim eine 2 mm fuge bei einformatigen verlegungen und 3 mm fuge bei formatkombinationen - Para lograr los máximos resultados en la posa del producto, Florim aconseja 2 mm de junta en aplicaciones monoformato y 3 mm en combinaciones de formatos mixtos.

**In relazione alle differenti tecnologie produttive l'accostamento di prodotti con spessori diversi potrebbe presentare delle disomogeneità, se ne sconsiglia pertanto l'abbinamento.** / Due to the different production technologies, contiguous installation of products with different thickness may give a non-homogeneous result. For this reason we do not recommend this option. / Vu que différentes technologies de production sont utilisées avec des épaisseurs différentes, des problèmes d'homogénéité pourraient se présenter, il est donc déconseillé de les poser ensemble. / Wegen unterschiedlicher Produktionstechnologien können die Fliesen mit verschiedenen Materialstärken optische Differenzen aufweisen. Von einem direkten Aneinanderlegen wird deshalb abgeraten. / Dadas las diferentes tecnologías productivas, la combinación de productos de diferentes espesores podría dar lugar a heterogeneidad, por lo que se desaconseja mezclarlas.



# EARTHTECH OUTDOOR / FULL BODY

## Vantaggi tecnici - Technical advantages - Avantages techniques Technische Vorteile - Ventajas técnicas

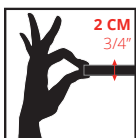

- Lastra monolitica compatta di spessore 2 cm squadrata e rettificata
- Compact monolithic slab 2 cm thick squared and rectified
- Dalle monolithique compacte de 2 cm d'épaisseur, équarrie et rectifiée
- Kompakte monolithische Platte, 2 cm dick, rechteckig und scharfkantig geschliffen
- Losa monolítica compacta de 2 cm de espesor, escuadrada y rectificada.

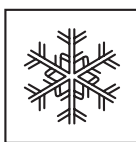

- INGELIVO
- FROST RESISTANT
- INGÉLIF
- FROSTBESTÄNDIG
- RESISTENTE A LA HELADA



- ELEVATA RESISTENZA AI CARICHI STATICI
- HIGH STATIC LOAD RESISTANCE
- RÉSISTANCE ÉLEVÉE AUX CHARGES STATIQUES
- HOHE STATISCHE BELASTBARKEIT
- ELEVADA RESISTENCIA A LAS CARGAS ESTÁTICAS



- FACILE DA POSARE
- EASY TO INSTALL
- FACILE À POSER
- VERLEGELEICHT
- FÁCIL DE COLOCAR



- ANTISCIVOLO R11
- ANTI SLIP R11
- ANTIDÉRAPANT R11
- RUTSCHFEST R11
- ANTIDESLIZANTE R11

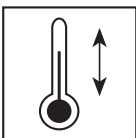

- RESISTENTE AGLI SBALZI TERMICI
- THERMAL SHOCK RESISTANT
- RÉSISTANT AUX ÉCARTS THERMIQUES
- TEMPERATURWECHSELBESTÄNDIG
- RESISTENTE A LAS OSCILACIONES TÉRMICAS



- FACILE DA PULIRE
- EASY TO CLEAN
- FACILE À NETTOYER
- REINIGUNGSLEICHT
- FÁCIL DE LIMPIAR

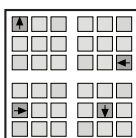

- RIMOVIBILE E RIUTILIZZABILE
- REMOVABLE AND REUSABLE
- DÉMONTABLE ET RÉUTILISABLE
- ENTFERNBAR UND WIEDERVERWENDBAR
- DESMONTABLE Y REUTILIZABLE



- INATTACCABILE DA AGENTI CHIMICI E MUFFE
- IMPERVIOUS TO ATTACK BY CHEMICALS OR MOULD
- RÉSISTANT AUX AGENTS CHIMIQUES ET AUX MOISSISSURES
- UNANGREIFBAR DURCH CHEMISCHE STOFFE UND SCHIMMEL
- RESISTENTE A LOS AGENTES QUÍMICOS Y A LOS MOHOS

## Applicazioni - Applications - Applications - Verlegung - Aplicaciones

- Posa diretta su erba
- Direct installation on grass
- Pose directe sur de l'herbe
- Verlegung direkt auf Rasen
- Colocación directa sobre hierba



- Posa diretta su ghiaia
- Direct installation over gravel
- Pose direct sur du gravier
- Verlegung direkt auf Kies
- Colocación directa sobre grava



- Posa su massetto cementizio
- Installation on sand-cement screed
- Pose sur chape ciment
- Verlegung auf Zement-Unterbetonblock
- Colocación sobre contrapiso de hormigón

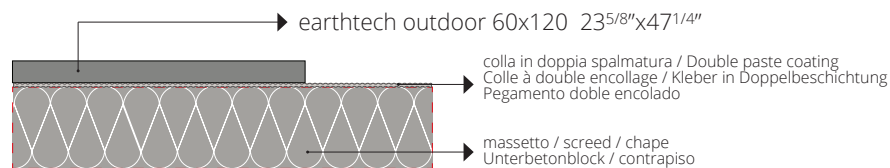

- Posa su piedini fissi o regolabili
- Installation on fixed or adjustable feet
- Pose sur pieds fixes ou réglables
- Verlegung auf feststehende oder regulierbare Füße
- Colocación sobre pies fijos o regulables

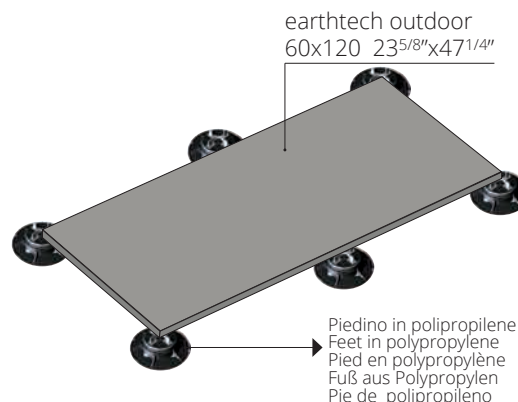

Per le specifiche di utilizzo dei sistemi sopraelevati vedi il sito florim.com  
For the specifics on use of raised systems visit the site florim.com  
Pour les caractéristiques d'utilisation des systèmes surélevés, voir le site florim.com  
Für die Nutzungsbedingungen der Doppelbodensysteme siehe Webseite florim.com  
Para las especificaciones de empleo de los sistemas sobreelevados consulte el sitio web florim.com

Le lastre ceramiche sono sottoposte a un trattamento di compattazione termica che assicura resistenza e durata nel tempo. Il bassissimo assorbimento d'acqua rende perciò il materiale ingelivo. Ciò può comportare ristagni d'acqua superficiali anche per materiale installato a regola d'arte. / Ceramic tiles undergo a compacting thermal treatment that ensures resistance and durability. The low level of water absorption makes the slabs frost resistant. This could result in superficial water stagnations even if materials are installed in a workmanlike manner. / Les carreaux de céramique subissent un traitement thermique de compactage qui assure résistance et durabilité. Le faible niveau d'absorption d'eau rend les dalles résistantes au gel. Il pourrait en résulter des stagnations d'eau superficielles, même si les dalles ont été installées dans les règles de l'art. / Die Keramikplatten werden einer thermischen Verdichtung unterzogen, welche die Widerstandsfähigkeit und Langlebigkeit sichert. Die extrem niedrige Wasseraufnahme macht das Material frostsicher. Die hohe Materialdichte kann, auch bei einer perfekten Verlegung, eine längere Abtrochnungszeit von angestaumtem Wasser zur Folge haben. / Las baldosas cerámicas se someten a un tratamiento de compactación térmica que asegura resistencia y durabilidad. La baja absorción de agua hace que las baldosas resistan al hielo. Esto podría resultar en estancamientos superficiales de agua, incluso si los materiales están instalados según las reglas del arte.

## PUMICE\_GROUND



## DESERT\_GROUND



**R11  
CLASSE C**

BS EN 16165  
ANNEX C  
>36 wet  
slider 96

DCOF>  
0,42 Wet

20 mm 3/4" ↑↓

## FOG\_GROUND



## CARBON\_GROUND



### GRES FINE PORCELLANATO

FINE PORCELAIN STONEWARE/GRES CERAME FIN/FEINSTEINZEUG-KOLLEKTIONEN/GRES PORCELANICO FINO  
SQUADRATO - SQUARED - EQUARRI - REKTIFIZIERT - ESCUADRADO

20 mm 3/4" ↑↓

|                  | COLOR         | SURFACE | 60x120<br>23 <sup>5/8</sup> "x47 <sup>1/4</sup> " |
|------------------|---------------|---------|---|
| <b>EARTHTECH</b> | PUMICE_GROUND | GRIP    | 771805  |
|                  | DESERT_GROUND | GRIP    | 771806  |
|                  | FOG_GROUND    | GRIP    | 771807  |
|                  | CARBON_GROUND | GRIP    | 771808  |



Recycled material content certification

### PUMICE\_GROUND

| ISO 10545-4 | RESISTENZA ALLA FLESSIONE IN N/mm <sup>2</sup><br>N/mm <sup>2</sup> FLEXURAL STRENGTH TEST / RESISTANCE<br>A LA FLEXION EN N/mm <sup>2</sup> / BIEGEFESTIGKEIT IN<br>N/mm <sup>2</sup> / RESISTENCIA A LA FLEXION EN N/mm <sup>2</sup> | valore medio<br>52 N/mm <sup>2</sup> |
|-------------|--|--------------------------------------|
|             | Forza di rottura in N (sp. > 7,5 mm)<br>Breaking strength in N (thickness > 7,5 mm) / Force de<br>rupture en N (ép. > 7,5 mm) / Bruchlast in N (Dicke ><br>7,5 mm) / Fuerza de rotura en N (g. > 7,5 mm)                               | valore medio<br>14000 N              |

| <b>EARTHTECH</b> | scatola - box |      |       | pallet |       |      |
|------------------|---------------|------|-------|--------|-------|------|
|                  | pz            | mq   | kg    | box    | mq    | kg   |
| 60x120 20mm      | 1             | 0,72 | 32,26 | 30     | 21,60 | 1000 |

### PEZZI SPECIALI

Special trims/Pièces spéciales/Formstücke  
Piezas especiales

pag 152/155





# FLOWTECH

gres fine porcellanato  
fine porcelain stoneware  
grès cérame fin  
feinsteinzeug-kollektionen  
gres porcelánico fino







## FLOWTECH / PREMIUM

Le lastre **Flowtech** permettono di arricchire ambienti pubblici e privati con il deciso fascino industriale delle lamiere metalliche. L'estetica coglie tutti i tratti iconici del materiale: è curata anche nei piccoli particolari e perfettamente bilanciata. A questo si aggiunge il vantaggio di un aspetto totalmente stabile nel tempo, e di una materia che non risente dell'umidità, dell'usura o di agenti atmosferici. Le tre varianti colore insieme all'assortimento di formati, dalle grandi lastre ai pratici sottoformati in varie misure, agevolano la posa in opera e la versatilità architettonica della collezione.

**Flowtech** panels enrich public and private spaces with the industrial charm of metallic sheeting. The aesthetic expresses all the iconic features of the material, even down to the smallest details, in perfect equilibrium. They also have the benefit of being unchanged by the passage of time, in a material which is immune to the effects of humidity, wear and atmospheric agents. The three colour variants, combined with a variety of sizes, from large panels to a number of handy smaller formats, make them easy to install and adapt to any setting.

Les dalles **Flowtech** confèrent aux espaces publics et privés le charme typiquement industriel des tôles métalliques. Leur esthétique, qui met en évidence toutes les caractéristiques du matériau, est soignée dans les moindres détails et parfaitement équilibrée. À cela s'ajoute l'avantage d'un aspect extrêmement durable et d'une matière résistante à l'humidité, à l'usure et aux agents atmosphériques. Les trois variantes de couleurs et l'assortiment de formats disponibles, des grandes dalles aux sous-formats pratiques proposés en plusieurs dimensions, facilitent la pose et permettent son application dans différents contextes architecturaux.

Die Platten von **Flowtech** machen es möglich öffentliche und private Bereiche um den deutlichen industriellen Reiz der Metallbleche zu bereichern. Die Ästhetik birgt alle ikonischen Züge des Materials: es ist auch in den kleinsten Einzelheiten gepflegt und perfekt ausgewogen. Hinzu kommen die Vorteile eines auf die Dauer absolut beständigen Aussehens und eines Materials, dem Feuchtigkeit, Verschleiß oder Umwelteinflüsse nicht schaden können. Die drei Farbvarianten, zusammen mit dem Sortiment an Formaten, von den großen Platten bis zu den praktischen Unterformaten in verschiedenen Größen, erleichtern die Verlegung an Ort und Stelle und die architektonische Vielseitigkeit der Kollektion.

Las losas **Flowtech** permiten enriquecer ambientes públicos y privados con el intenso encanto industrial de las chapas metálicas. La estética abarca todos los rasgos icónicos del material: está cuidada incluso en los pequeños detalles y perfectamente equilibrada. A esto se añade la ventaja de un aspecto totalmente estable en el tiempo y de una materia que no se resiente a la humedad, al desgaste o a los agentes atmosféricos. Las tres variantes de color junto al surtido de formatos, desde las grandes losas hasta los prácticos subformatos en varias medidas, facilitan la colocación en la obra y la versatilidad arquitectónica de la colección.



# FLOWTECH / PREMIUM

## RUSSET



## AGED BRONZE

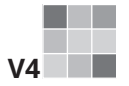

V4

R9

DCOF>  
0,42 Wet

9 mm 3/8" ↑↓



V4

R9





(naturale/  
matte)

DCOF>  
0,42 Wet

6 mm 1/4" ↑↓

FLOFORM OVERSIZE  
magnUlm

**GRES FINE PORCELLANATO**  
FINE PORCELAIN STONEWARE / GRÈS CÉRAME FIN / FEINSTEINZEUG-KOLLEKTIONEN / GRES PORCELÁNICO FINO  
SQUADRATO - SQUARED - EQUARRI - REKTIFIZIERT - ESCUADRADO

| 9 mm 3/8" ↑↓ |   | COLOR       | SURFACE  | 60x120<br>23 <sup>5/8"</sup> x47 <sup>1/4"</sup> |                    |   |   |  |
|--------------|---|-------------|----------|--|--------------------|---|---|--|
| FLOWTECH     |  | RUSSET      | NATURALE | 757070   |                    |   |   |  |
|              |  | AGED BRONZE | NATURALE | 757071   |                    |   |   |  |
| 6 mm 1/4" ↑↓ |   | COLOR       | SURFACE  | 160x320<br>63"x126"                              | 160x160<br>63"x63" | 120x240<br>47 <sup>1/4"</sup> x94 <sup>1/2"</sup> | 120x120<br>47 <sup>1/4"</sup> x47 <sup>1/4"</sup> | 60x120<br>23 <sup>5/8"</sup> x47 <sup>1/4"</sup> |
| FLOWTECH     |  | RUSSET      | NATURALE | 757908   | 757911             | 756645  | 757061  | 757058   |
|              |  | AGED BRONZE | NATURALE | 757909   | 757912             | 756646  | 757062  | 757059   |



## BURNISHED



V4

R9

DCOF>  
0,42 Wet

9 mm 3/8" ↑↓

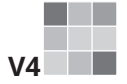

V4

R9

(naturale/  
matte)

DCOF>  
0,42 Wet

6 mm 1/4" ↑↓

FLOHM OVERSIZE  
magnUm

### GRES FINE PORCELLANATO

FINE PORCELAIN STONEWARE / GRÈS CÉRAME FIN / FEINSTEINZEUG-KOLLEKTIONEN / GRES PORCELÁNICO FINO  
SQUADRATO - SQUARED - EQUARRI - REKTIFIZIERT - ESCUADRADO







| 9 mm 3/8" ↑↓ | COLOR   | SURFACE               | 60x120<br>23 <sup>5/8</sup> "x47 <sup>1/4</sup> " |
|--------------|---|-----------------------|---|
| FLOWTECH     |  | BURNISHED<br>NATURALE | 757072  |

| 6 mm 1/4" ↑↓ | COLOR   | SURFACE               | 160x320<br>63"x126" | 160x160<br>63"x63" | 120x240<br>47 <sup>1/4</sup> "x94 <sup>1/2</sup> " | 120x120<br>47 <sup>1/4</sup> "x47 <sup>1/4</sup> " | 60x120<br>23 <sup>5/8</sup> "x47 <sup>1/4</sup> " |
|--------------|---|-----------------------|---------------------|--------------------|--|--|---|
| FLOWTECH     |  | BURNISHED<br>NATURALE | 757910              | 757913             | 756647   | 757063   | 757060  |

# FLOWTECH / PREMIUM

| 9 mm 3/8" ↑↓ | COLOR   | SURFACE     | 21x40<br>8 <sup>1/4"</sup> x15 <sup>3/4"</sup>   |        |
|--------------|---|-------------|--|--------|
|              |   |             | <br>modulo<br>listello sfalsato<br>pz/box 5 |        |
| FLOWTECH     |  | RUSSET      | NATURALE   | 756615 |
|              |  | AGED BRONZE | NATURALE   | 756616 |
|              |  | BURNISHED   | NATURALE   | 756617 |

## PEZZI SPECIALI/SPECIAL TRIMS/PIÈCES SPÉCIALES/FORMSTÜCKE/PIEZAS ESPECIALES









| 9 mm 3/8" ↑↓ | COLOR   | SURFACE     | 33x120x3<br>13"x47 <sup>1/4"</sup> x1 <sup>1/8"</sup>  | 33x120x3<br>13"x47 <sup>1/4"</sup> x1 <sup>1/8"</sup>   | 33x120x3<br>13"x47 <sup>1/4"</sup> x1 <sup>1/8"</sup>  |        |
|--------------|---|-------------|--|---|--|--------|
|              |   |             | <br>gradino<br>pz/box 2 | <br>angolo gradino dx<br>pz/box 2 | <br>angolo gradino sx<br>pz/box 2 |        |
| FLOWTECH     |   | RUSSET      | NATURALE   | 758216  | 758219   | 758222 |
|              |  | AGED BRONZE | NATURALE   | 758217  | 758220   | 758223 |
|              |  | BURNISHED   | NATURALE   | 758218  | 758221   | 758224 |



| FLOWTECH | scatola - box |      |       | pallet |       |     |
|----------|---------------|------|-------|--------|-------|-----|
|          | pz            | mq   | kg    | box    | mq    | kg  |
| 60x120   | 2             | 1,44 | 28,08 | 30     | 43,20 | 870 |

| FLOWTECH          | scatola - box |      |      | pallet |    |    |
|-------------------|---------------|------|------|--------|----|----|
|                   | pz            | ml   | kg   | box    | mq | kg |
| 4,6x80 battiscopa | 12            | 9,60 | 9,60 | -      | -  | -  |

PEZZI SPECIALI/SPECIAL TRIMS  
PIÈCES SPÉCIALES/FORMSTÜCKE  
PIEZAS ESPECIALES

| 6 mm 1/4"  |   | COLOR       | SURFACE  | <b>30x30</b><br>11 4/5" x 11 4/5"<br><br>mosaico<br>tessere 7,5x7,5<br><b>pz/box 11</b> | <b>30x30</b><br>11 4/5" x 11 4/5"<br><br>muretto<br>tessere 7,5x15<br><b>pz/box 11</b> | <b>30x30</b><br>11 4/5" x 11 4/5"<br><br>mosaico<br>tessere 1,5x3<br><b>pz/box 11</b> | <b>4,6x60</b><br>1 4/5" x 23 5/8"<br><br>battiscopa |
|--|---|-------------|----------|--|---|--|--|
| <b>FLOWTECH</b>  |  | RUSSET      | NATURALE | 756624   | 756621  | 756627   | 756630   |
|  |  | AGED BRONZE | NATURALE | 756625   | 756622  | 756628   | 756631   |
|  |  | BURNISHED   | NATURALE | 756626   | 756623  | 756629   | 756632   |

FLORIM OVERSIZE  
**magnUm**

**160x320/160x160/120x240/120x120/60x120**  
 Specifica Imballo pag.  
 Packaging specifications on page  
 Spécifications d'emballage à page  
 Verpackungsdetail Seite  
 Especificaciones de embalaje a la página  
**162/163**

**I formati 160x160 e 80x240 posso essere acquistati solo a multipli di 2 lastre.** / Sales unit for 160x160 and 80x240 is 2 pcs, so they can only be bought in multiples of 2. / Les formats 160x160 et 80x240 sont vendus par multiples de 2 plaques / Die Formate 160x160 und 80x240 können nur in einer durch 2 teilbaren Anzahl bestellt werden / Las medidas 160x160 y 80x240 solo pueden comprarse en múltiplos de 2 placas.

**Per un effetto ottimale della posa, Florim suggerisce di mantenere 2 mm di fuga per pose monoformato e 3 mm per combinare formati misti.** - For optimal installation results, Florim recommends maintaining a joint of 2 mm 1/12" for single format installations and 3 mm 1/8" to combine mixed formats. - Pour réaliser une pose parfait, Florim conseille de laisser 2 mm de joint pour la pose des monoformats et 3 mm pour les combinaisons de formats mixtes. - Um einen optimalen effekt beim verlegen zu erzielen empfiehlt Florim eine 2 mm fuge bei einformatigen verlegungen und 3 mm fuge bei formatkombinationen - Para lograr los máximos resultados en la posa del producto, Florim aconseja 2 mm de junta en aplicaciones monoformato y 3 mm en combinaciones de formatos mixtos.

**In relazione alle differenti tecnologie produttive l'accostamento di prodotti con spessori diversi potrebbe presentare delle disomogeneità, se ne sconsiglia pertanto l'abbinamento.** / Due to the different production technologies, contiguous installation of products with different thickness may give a non-homogeneous result. For this reason we do not recommend this option. / Vu que différentes technologies de production sont utilisées avec des épaisseurs différentes, des problèmes d'homogénéité pourraient se présenter, il est donc déconseillé de les poser ensemble. / Wegen unterschiedlicher Produktionstechnologien können die Fliesen mit verschiedenen Materialstärken optische Differenzen aufweisen. Von einem direkten Aneinanderlegen wird deshalb abgeraten. / Dadas las diferentes tecnologías productivas, la combinación de productos de diferentes espesores podría dar lugar a heterogeneidad, por lo que se desaconseja mezclarlas.

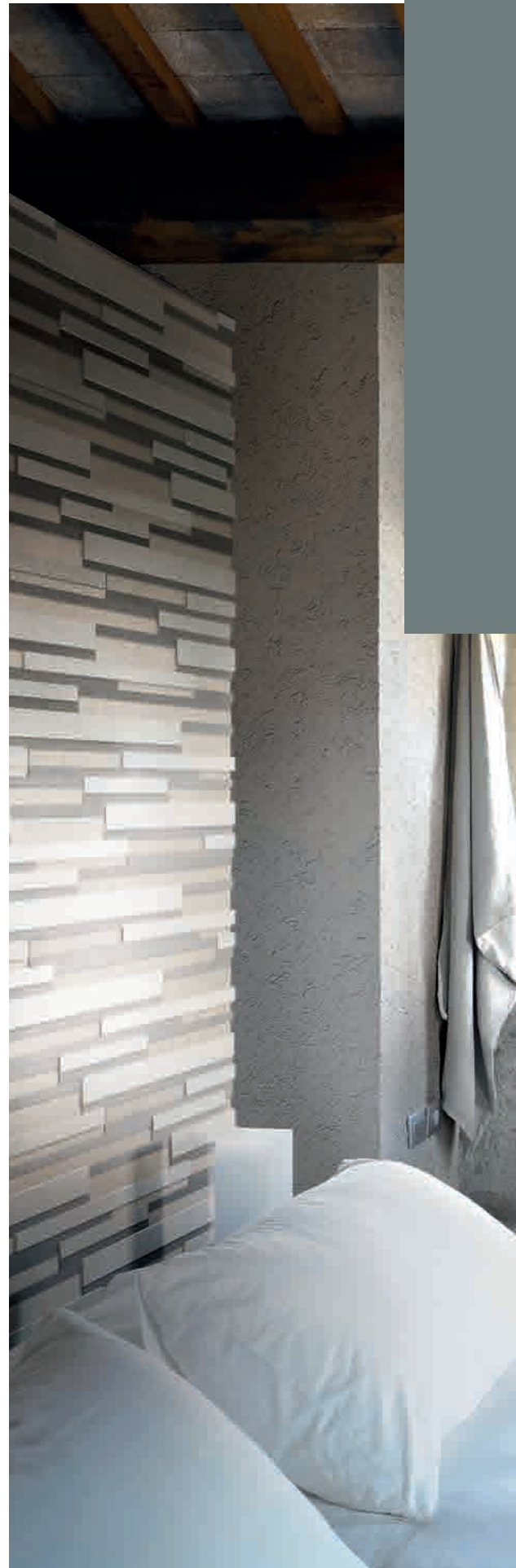



# INDUSTRIAL

gres fine porcellanato  
fine porcelain stoneware  
grès cérame fin  
feinsteinzeug-kollektionen  
gres porcelánico fino





## INDUSTRIAL / PREMIUM

Modernità e semplicità caratterizzano questa superficie neutra e lineare che si esprime attraverso un mix di colori, formati e decori. **Industrial** si propone nella sua forma pura, per essere utilizzata in modo trasversale, efficace e accattivante in ogni progetto di architettura.

This neutral and linear surface is distinguished for being modern and simple, expressing itself through a mix of colours, sizes and decorations. **Industrial** presents itself in its purest form, to be used across the board, efficiently and captivately, in every architectural project.

Modernité et simplicité caractérisent cette surface neutre et linéaire qui s'exprime dans un mélange de coloris, de formats et de décors. Efficace et captivante dans tous les projets d'architecture, **Industrial** se propose dans sa forme pure pour être utilisée de façon transversale.

Modernität und Einfachheit kennzeichnen diese neutrale und lineare Oberfläche, die sich durch einen Mix aus Farben, Formaten und Dekoren ausdrückt. **Industrial** bietet sich in seiner puren Form an, um übergreifend, effizient und ansprechend in jedem Architekturprojekt verwendet werden zu können.

Esta superficie neutra y lineal, que se expresa a través de una mezcla de colores, formatos y decoraciones, se caracteriza por su gran modernidad y simplicidad. **Industrial** se propone en su forma pura, para ser usada transversalmente, eficaz y fascinante en cualquier proyecto de arquitectura.

# INDUSTRIAL / PREMIUM

## IVORY



## TAUPE



**R10**  
**Classe B**  
(naturale)

**R9**  
**Classe A**  
(soft)

**R11**  
**Classe C**  
(bocciardato)

DCOF>  
0,42 Wet

9 mm 3/8" ↑↓



**R9**  
(matte)

**R10**  
**Classe B**  
(R+PTV)

DCOF>  
0,42 Wet

BS EN 16165  
ANNEX C  
>36 wet  
slider 96  
(R+PTV)

6 mm 1/4" ↑↓

FLOORING OVERSIZE  
**magnuM**

**GRES FINE PORCELLANATO**  
FINE PORCELAIN STONEWARE / GRÈS CÉRAMÉ FIN / FEINSTEINZEUG-KOLLEKTIONEN / GRES PORCELÁNICO FINO  
SQUADRATO - SQUARED - EQUARRI - REKTIFIZIERT - ESCUADRADO

| 9 mm 3/8" ↑↓      | COLOR | SURFACE     | 60x120<br>23 <sup>5/8</sup> "x47 <sup>1/4</sup> " | 80x80<br>31 <sup>1/2</sup> "x31 <sup>1/2</sup> " | 60x60<br>23 <sup>5/8</sup> "x23 <sup>5/8</sup> " | 30x60<br>11 <sup>4/5</sup> "x23 <sup>5/8</sup> " |
|-------------------|-------|-------------|---|--|--|--|
| <b>INDUSTRIAL</b> | IVORY | NATURALE    | 738816  | 738656   | 738803   | 738791   |
|                   |       | SOFT        | 738822  | 738662   | 738810   | 738797   |
|                   |       | BOCCIARDATO | -   | -  | -  | 738955   |
|                   | TAUPE | NATURALE    | 738819  | 738659   | 738807   | 738794   |
|                   |       | SOFT        | 738825  | 738665   | 738813   | 738800   |
|                   |       | BOCCIARDATO | -   | -  | -  | 738958   |

| 6 mm 1/4" ↑↓      | COLOR | SURFACE  | 160x320<br>63"x126" | 160x160<br>63"x63" | 120x280<br>47 <sup>1/4</sup> "x110 <sup>1/4</sup> " | 120x240<br>47 <sup>1/4</sup> "x94 <sup>1/2</sup> " | 120x120<br>47 <sup>1/4</sup> "x47 <sup>1/4</sup> " | 80x80<br>31 <sup>1/2</sup> "x31 <sup>1/2</sup> " | 60x120<br>23 <sup>5/8</sup> "x47 <sup>1/4</sup> " |
|-------------------|-------|----------|---------------------|--------------------|---|--|--|--|---|
| <b>INDUSTRIAL</b> | IVORY | NATURALE | 744351              | 744393             | 757774  | 744399   | 744405   | 744381   | 744411  |
|                   |       | R+PTV    | -                   | -                  | -   | 758799   | 757780   | -  | -   |
|                   | TAUPE | NATURALE | 744352              | 744394             | 757775  | 744400   | 744406   | 744382   | 744412  |
|                   |       | R+PTV    | -                   | -                  | -   | 758800   | 757781   | -  | -   |



## MOKA



## SAGE



**V2**  
**R10**  
**Classe B**  
 (naturale)

**R9**  
**Classe A**  
 (soft)

**R11**  
**Classe C**  
 (bocciardato)

DCOF>  
 0,42 Wet

**9 mm** 3/8" ↑↓



**V2**  
**R9**  
 (matte)

**R10**  
**Classe B**  
 (R+PTV)

DCOF>  
 0,42 Wet

BS EN 16165  
 ANNEX C  
 >36 wet  
 slider 96  
 (R+PTV)

**6 mm** 1/4" ↑↓

FLOHM OVERSIZE  
**magnUm**

**GRES FINE PORCELLANATO**  
 FINE PORCELAIN STONEWARE / GRÈS CÉRAME FIN / FEINSTEINZEUG-KOLLEKTIONEN / GRES PORCELÁNICO FINO  
 SQUADRATO - SQUARED - EQUARRI - REKTIFIZIERT - ESCUADRADO

| 9 mm 3/8" ↑↓      |      | COLOR       | SURFACE | 60x120<br>23 <sup>5/8</sup> "x47 <sup>1/4</sup> " | 80x80<br>31 <sup>1/2</sup> "x31 <sup>1/2</sup> " | 60x60<br>23 <sup>5/8</sup> "x23 <sup>5/8</sup> "    | 30x60<br>11 <sup>4/5</sup> "x23 <sup>5/8</sup> "   |  |  |   |
|-------------------|------|-------------|---------|---|--|---|--|--|--|---|
| <b>INDUSTRIAL</b> | MOKA | NATURALE    |         | 738820  | 738660   | 738808  | 738795   |  |  |   |
|                   |      | SOFT        |         | 738826  | 738666   | 738814  | 738801   |  |  |   |
|                   |      | BOCCIARDATO |         | -   | -  | -   | 738959   |  |  |   |
|                   | SAGE | NATURALE    |         | 738817  | 738657   | 738804  | 738792   |  |  |   |
|                   |      | SOFT        |         | 738823  | 738663   | 738811  | 738798   |  |  |   |
|                   |      | BOCCIARDATO |         | -   | -  | -   | 738956   |  |  |   |
| 6 mm 1/4" ↑↓      |      | COLOR       | SURFACE | 160x320<br>63"x126"                               | 160x160<br>63"x63"                               | 120x280<br>47 <sup>1/4</sup> "x110 <sup>1/4</sup> " | 120x240<br>47 <sup>1/4</sup> "x94 <sup>1/2</sup> " | 120x120<br>47 <sup>1/4</sup> "x47 <sup>1/4</sup> " | 80x80<br>31 <sup>1/2</sup> "x31 <sup>1/2</sup> " | 60x120<br>23 <sup>5/8</sup> "x47 <sup>1/4</sup> " |
| <b>INDUSTRIAL</b> | MOKA | NATURALE    |         | 744354  | 744396   | 757776  | 744402   | 744408   | 744384   | 744414  |
|                   |      | R+PTV       |         | -   | -  | -   | 758801   | 757782   | -  | -   |
|                   | SAGE | NATURALE    |         | 744353  | 744395   | 757777  | 744401   | 744407   | 744383   | 744413  |
|                   |      | R+PTV       |         | -   | -  | -   | 758802   | 757783   | -  | -   |

# INDUSTRIAL / PREMIUM

## STEEL



## PLOMB

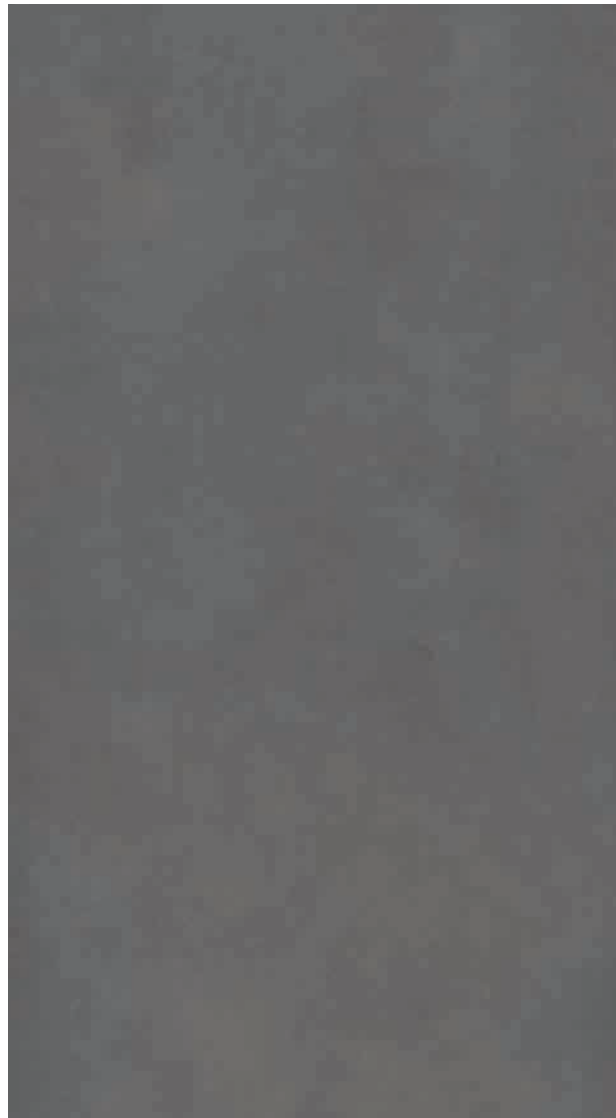

**V2**  
**R10**  
**Classe B**  
 (naturale)

**R9**  
**Classe A**  
 (soft)

**R11**  
**Classe C**  
 (bocciardato)

DCOF>  
 0,42 Wet

**9 mm** 3/8" ↑↓



**V2**  
**R9**  
 (matte)

**R10**  
**Classe B**  
 (R+PTV)

DCOF>  
 0,42 Wet

BS EN 16165  
 ANNEX C  
 >36 wet  
 slider 96  
 (R+PTV)

**6 mm** 1/4" ↑↓

FLOORING OVERSIZE  
**magnUm**

**GRES FINE PORCELLANATO**  
 FINE PORCELAIN STONEWARE / GRÈS CÉRAME FIN / FEINSTEINZEUG-KOLLEKTIONEN / GRES PORCELÁNICO FINO  
 SQUADRATO - SQUARED - EQUARRI - REKTIFIZIERT - ESCUADRADO

| 9 mm 3/8" ↑↓      |       | COLOR       | SURFACE | 60x120<br>23 <sup>5/8</sup> "x47 <sup>1/4</sup> " | 80x80<br>31 <sup>1/2</sup> "x31 <sup>1/2</sup> " | 60x60<br>23 <sup>5/8</sup> "x23 <sup>5/8</sup> "    | 30x60<br>11 <sup>4/5</sup> "x23 <sup>5/8</sup> "   |  |  |   |
|-------------------|-------|-------------|---------|---|--|---|--|--|--|---|
| <b>INDUSTRIAL</b> | STEEL | NATURALE    |         | 738818  | 738658   | 738806  | 738793   |  |  |   |
|                   |       | SOFT        |         | 738824  | 738664   | 738812  | 738799   |  |  |   |
|                   |       | BOCCIARDATO |         | -   | -  | -   | 738957   |  |  |   |
|                   | PLOMB | NATURALE    |         | 738821  | 738661   | 738809  | 738796   |  |  |   |
|                   |       | SOFT        |         | 738827  | 738667   | 738815  | 738802   |  |  |   |
|                   |       | BOCCIARDATO |         | -   | -  | -   | 738960   |  |  |   |
| 6 mm 1/4" ↑↓      |       | COLOR       | SURFACE | 160x320<br>63"x126"                               | 160x160<br>63"x63"                               | 120x280<br>47 <sup>1/4</sup> "x110 <sup>1/4</sup> " | 120x240<br>47 <sup>1/4</sup> "x94 <sup>1/2</sup> " | 120x120<br>47 <sup>1/4</sup> "x47 <sup>1/4</sup> " | 80x80<br>31 <sup>1/2</sup> "x31 <sup>1/2</sup> " | 60x120<br>23 <sup>5/8</sup> "x47 <sup>1/4</sup> " |
| <b>INDUSTRIAL</b> | STEEL | NATURALE    |         | 744350  | 744392   | 757778  | 744398   | 744404   | 744380   | 744410  |
|                   |       | R+PTV       |         | -   | -  | -   | 758803   | 757784   | -  | -   |
|                   | PLOMB | NATURALE    |         | 744355  | 744397   | 757779  | 744403   | 744409   | 744385   | 744415  |
|                   |       | R+PTV       |         | -   | -  | -   | 758804   | 757785   | -  | -   |

9 mm 3/8" 

COLOR

SURFACE

**30x30**  
11 4/5" x 11 4/5"  
pz/box 4

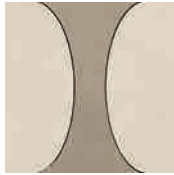

DECORO A  
TAUPE / IVORY

SOFT

739434

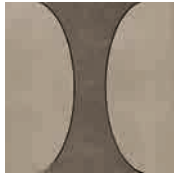

DECORO A  
MOKA / TAUPE

SOFT

739436

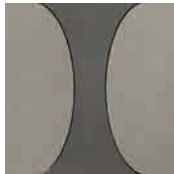

DECORO A  
PLOMB / STEEL

SOFT

739437

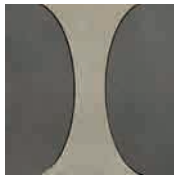

DECORO A  
SAGE / PLOMB

SOFT

739435

## INDUSTRIAL



DECORO B  
TAUPE / IVORY

SOFT

739438



DECORO B  
MOKA / TAUPE

SOFT

739440



DECORO B  
PLOMB / STEEL

SOFT

739441



DECORO B  
SAGE / PLOMB

SOFT

739439

## PUZZLE DECOR

La fuga diventa decoro, la separazione della materia acquista una nuova espressività grazie alla tecnologia dell'idrogetto. Ogni realizzazione può essere unica e personalizzata in base allo spazio in cui dovrà essere inserita, il decoro può essere adattato a qualsiasi misura richiesta. Fuga tra i pezzi 1 mm. Per la realizzazione del progetto serve la pianta del cliente con indicazione precisa delle misure delle pareti da rivestire. Nel caso in cui non ci siano pareti perfettamente in squadra i pezzi ai lati saranno lasciati più lunghi di 5 cm.

Joint spaces become part of the decoration. The space that separates the material acquires a new level of expression thanks to water-jet technology. Each project can be unique and customised based on the area where it will be installed. The decoration can be adapted to any requested measurements. 1 mm joint space between tiles. The customer's floor plan is required to design the project, providing the precise measurements of the walls where the material will be applied. If the walls are not perfectly square, the side pieces must be left 5 cm longer.

Le joint devient une décoration, la séparation de la matière acquiert une nouvelle expressivité grâce à la technologie de l'hydrojet. Toutes les réalisations peuvent être uniques et personnalisées selon l'espace où elles devront être insérées, la décoration peut être adaptée à toute mesure demandée. Joint entre les pièces 1 mm. Pour la réalisation du projet, il faut le plan du client avec l'indication précise des mesures des murs à couvrir. Au cas où les murs ne seraient pas parfaitement en équerre, les pièces sur les côtés seront laissées plus longues de 5 cm.

Die Fuge wird zum Dekor; die Trennung der Materie erlangt dank der Wasserstrahltechnologie eine neue Ausdruckskraft. Jede Umsetzung kann einzigartig sein und je nach Raum, in den sie eingefügt werden soll, personalisiert werden. Das Dekor kann jeder gewünschten Größe angepasst werden. Fuge zwischen den Teilen 1 mm. Zur Umsetzung des Projekts wird der Plan des Kunden mit genauer Angabe der Maße der zu verkleidenden Wand benötigt. Im Falle von nicht perfekt quadratischen Wänden werden die an den Seiten befindlichen Teile 5 cm länger gelassen.

La junta se vuelve decoración, la separación de la materia adquiere una nueva expresión gracias a la tecnología de la propulsión por chorro de agua. Toda realización puede ser única y personalizada en base al espacio en el que se deberá colocar, la decoración se puede adaptar a cualquier medida requerida. Junta entre las piezas de 1 mm. Para llevar a cabo el proyecto es necesario contar con la planta del cliente, que indica con precisión las medidas de las paredes que hay que revestir. En el caso en el que no se cuente con paredes perfectamente en ángulo agudo, las piezas de los lados tendrán una longitud superior a los 5 cm.

### PUZZLE DECOR 739829

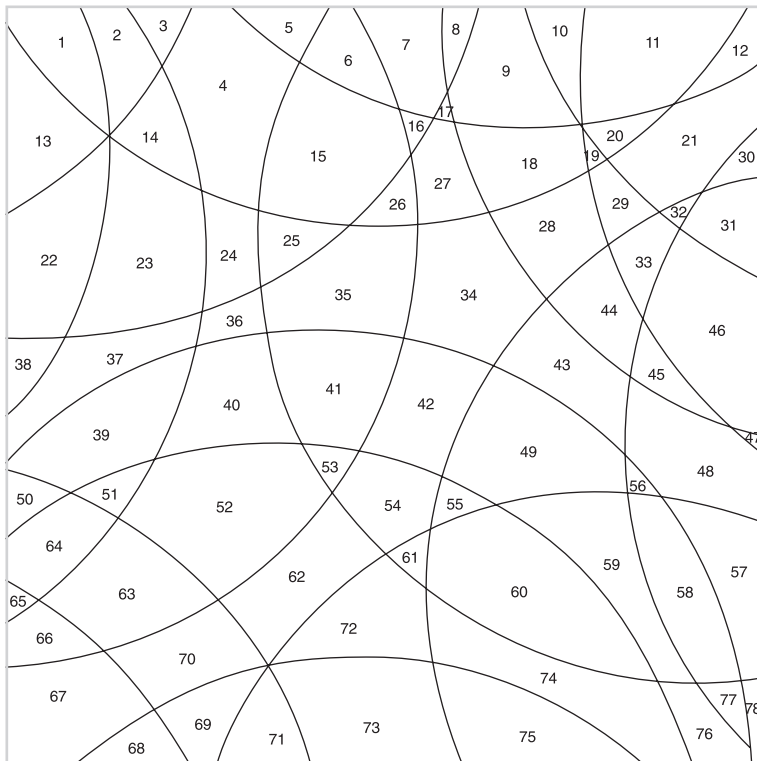

Esempio: per la realizzazione di un pannello di 160x160 cm il consumo sarà di 6 pezzi nel formato 80x80.

Example: covering a 160x160 cm panel will require the use of six 80x80 pieces.









Exemple: pour la réalisation d'un panneau de 160x160 cm, on consommera 6 pièces au format 80x80.

Beispiel: Zur Fertigung einer Platte von 160x160 cm liegt der Verbrauch bei 6 Teilen im Format 80x80.











Ejemplo: para la realización de un panel de 160x160 cm el consumo será de 6 piezas en el formato 80x80.

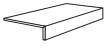

# Architectural design

| 9 mm 3/8" ↑↓      |   | COLOR | SURFACE  | 30x30<br>11 4/5" x 11 4/5"<br><br>mosaico tessere 3x3 | 15x60<br>6" x 23 5/8"<br><br>modulo listello mix 3D soft<br>pz/box 6 |
|-------------------|---|-------|----------|--|---|
| <b>INDUSTRIAL</b> |  | IVORY | NATURALE | 739130   | SAGE-PLOMB-STEEL<br>739190  |
|                   |  | TAUPE | NATURALE | 739133   | IVORY-MOKA-TAUPE<br>739191  |
|                   |  | MOKA  | NATURALE | 739134   |   |
|                   |  | SAGE  | NATURALE | 739131   |   |
|                   |  | STEEL | NATURALE | 739132   |   |
|                   |  | PLOMB | NATURALE | 739135   |   |

## PEZZI SPECIALI/SPECIAL TRIMS/PIÈCES SPÉCIALES/FORMSTÜCKE/PIEZAS ESPECIALES

| 9 mm 3/8" ↑↓      |   | COLOR | SURFACE     | 4,6x60<br>1 4/5" x 23 5/8"<br><br>battiscopa | 33x120x3<br>13" x 47 1/4" x 1 1/8"<br><br>gradino<br>pz/box 2 | 33x120x3<br>13" x 47 1/4" x 1 1/8"<br><br>angolo gradino dx<br>pz/box 2 | 33x120x3<br>13" x 47 1/4" x 1 1/8"<br><br>angolo gradino sx<br>pz/box 2 | 33x120x3<br>13" x 47 1/4" x 1 1/8"<br><br>angolo gradino<br>dx/sx<br>pz/box 1 | 15x60x6<br>6" x 23 5/8" x 2 1/8"<br><br>elemento elle<br>pz/box 4 |
|-------------------|---|-------|-------------|---|--|---|--|--|--|
| <b>INDUSTRIAL</b> |  | IVORY | NATURALE    | 745535  | 739142   | 739148  | 739154   | 739422   | -  |
|                   |   |       | SOFT        | 745541  | 739160   | 739166  | 739172   | 739428   | -  |
|                   |   |       | BOCCIARDATO | -   | -  | -   | -  | -  | 739136   |
|                   |  | TAUPE | NATURALE    | 745540  | 739145   | 739151  | 739157   | 739425   | -  |
|                   |   |       | SOFT        | 745546  | 739163   | 739169  | 739175   | 739431   | -  |
|                   |   |       | BOCCIARDATO | -   | -  | -   | -  | -  | 739139   |
|                   |  | MOKA  | NATURALE    | 745536  | 739146   | 739152  | 739158   | 739426   | -  |
|                   |   |       | SOFT        | 745542  | 739164   | 739170  | 739176   | 739432   | -  |
|                   |   |       | BOCCIARDATO | -   | -  | -   | -  | -  | 739140   |
|                   |  | SAGE  | NATURALE    | 745538  | 739143   | 739149  | 739155   | 739423   | -  |
|                   |   |       | SOFT        | 745544  | 739161   | 739167  | 739173   | 739429   | -  |
|                   |   |       | BOCCIARDATO | -   | -  | -   | -  | -  | 739137   |
|                   |  | STEEL | NATURALE    | 745539  | 739144   | 739150  | 739156   | 739424   | -  |
|                   |   |       | SOFT        | 745545  | 739162   | 739168  | 739174   | 739430   | -  |
|                   |   |       | BOCCIARDATO | -   | -  | -   | -  | -  | 739138   |
|                   |  | PLOMB | NATURALE    | 745537  | 739147   | 739153  | 739159   | 739427   | -  |
|                   |   |       | SOFT        | 745543  | 739165   | 739171  | 739177   | 739433   | -  |
|                   |   |       | BOCCIARDATO | -   | -  | -   | -  | -  | 739141   |

# INDUSTRIAL / PREMIUM

PEZZI SPECIALI/SPECIAL TRIMS  
PIÈCES SPÉCIALES/FORMSTÜCKE  
PIEZAS ESPECIALES

| 6 mm 1/4" ↑ | COLOR | SURFACE  | 30x30<br>11 4/5" x 11 4/5"              | 30x30<br>11 4/5" x 11 4/5"             | 30x30<br>11 4/5" x 11 4/5"            | 4,6x80<br>1 4/5" x 3 1/2" |
|-------------|-------|----------|---|--|---------------------------------------|---------------------------|
|             |       |          | mosaico<br>tessere 7,5x7,5<br>pz/box 11 | muretto<br>tessere 7,5x15<br>pz/box 11 | mosaico<br>tessere 1,5x3<br>pz/box 11 | battiscopa                |
| INDUSTRIAL  | IVORY | NATURALE | 747722                                  | 747732                                 | 747742                                | 747857                    |
|             | TAUPE | NATURALE | 747723                                  | 747733                                 | 747743                                | 747858                    |
|             | MOKA  | NATURALE | 747724                                  | 747734                                 | 747744                                | 747859                    |
|             | SAGE  | NATURALE | 747725                                  | 747735                                 | 747745                                | 747860                    |
|             | STEEL | NATURALE | 747726                                  | 747736                                 | 747746                                | 747861                    |
|             | PLOMB | NATURALE | 747727                                  | 747737                                 | 747747                                | 747862                    |



Recycled material content certification

FLORIM OVERSIZE  
**magnUm**

160x320/160x160/120x280/120x240  
120x120/80x80/60x120

Specifica Imballo pag.  
Packaging specifications on page  
Spécifications d'emballage à page  
Verpackungsdetail Seite  
Especificaciones de embalaje a la página  
**162/163**

| INDUSTRIAL    | scatola - box |      |       | pallet |       |      |
|---------------|---------------|------|-------|--------|-------|------|
|               | pz            | mq   | kg    | box    | mq    | kg   |
| 60x120        | 2             | 1,44 | 28,44 | 30     | 43,20 | 880  |
| 80x80         | 2             | 1,28 | 25,28 | 40     | 51,20 | 1040 |
| 60x60         | 3             | 1,08 | 21,33 | 40     | 43,20 | 880  |
| 30x60         | 6             | 1,08 | 21,33 | 40     | 43,20 | 880  |
| 30x30 mosaico | 11            | 1,00 | 23,20 | 30     | 30,00 | 720  |
| puzzle decor  | 1             | 1,00 | 23,40 | 6      | 6,00  | 170  |

**I formati 160x160 e 80x240 posso essere acquistati solo a multipli di 2 lastre.** / Sales unit for 160x160 and 80x240 is 2 pcs, so they can only be bought in multiples of 2. / Les formats 160x160 et 80x240 sont vendus par multiples de 2 plaques / Die Formate 160x160 und 80x240 können nur in einer durch 2 teilbaren Anzahl bestellt werden / Las medidas 160x160 y 80x240 solo pueden comprarse en múltiplos de 2 placas.

**Per un effetto ottimale della posa, Florim suggerisce di mantenere 2 mm di fuga per pose monofornato e 3 mm per combinare formati misti.** - For optimal installation results, Florim recommends maintaining a joint of 2 mm 1/12" for single format installations and 3 mm 1/8" to combine mixed formats. - Pour réaliser une pose parfait, Florim conseille de laisser 2 mm de joint pour la pose des monofornats et 3 mm pour les combinaisons de formats mixtes. - Um einen optimalen effekt beim verlegen zu erzielen empfiehlt Florim eine 2 mm fuge bei einformatigen verlegungen und 3 mm fuge bei formatkombinationen - Para lograr los máximos resultados en la posa del producto, Florim aconseja 2 mm de junta en aplicaciones monofornato y 3 mm en combinaciones de formatos mixtos.

| INDUSTRIAL        | scatola - box |      |      | pallet |    |    |
|-------------------|---------------|------|------|--------|----|----|
|                   | pz            | ml   | kg   | box    | mq | kg |
| 4,6x60 battiscopa | 14            | 8,40 | 8,40 | -      | -  | -  |

**In relazione alle differenti tecnologie produttive l'accostamento di prodotti con spessori diversi potrebbe presentare delle disomogeneità, se ne sconsiglia pertanto l'abbinamento.** / Due to the different production technologies, contiguous installation of products with different thickness may give a non-homogeneous result. For this reason we do not recommend this option. / Vu que différentes technologies de production sont utilisées avec des épaisseurs différentes, des problèmes d'homogénéité pourraient se présenter, il est donc déconseillé de les poser ensemble. / Wegen unterschiedlicher Produktionstechnologien können die Fliesen mit verschiedenen Materialstärken optische Differenzen aufweisen. Von einem direkten Aneinanderlegen wird deshalb abgeraten. / Dadas las diferentes tecnologías productivas, la combinación de productos de diferentes espesores podría dar lugar a heterogeneidad, por lo que se desaconseja mezclarlas.



# INDUSTRIAL OUTDOOR / PREMIUM

## Vantaggi tecnici - Technical advantages - Avantages techniques Technische Vorteile - Ventajas técnicas

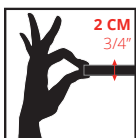

- Lastra monolitica compatta di spessore 2 cm squadrata e rettificata
- Compact monolithic slab 2 cm thick squared and rectified
- Dalle monolithique compacte de 2 cm d'épaisseur, équarrie et rectifiée
- Kompakte monolithische Platte, 2 cm dick, rechteckig und scharfkantig geschliffen
- Losa monolítica compacta de 2 cm de espesor, escuadrada y rectificada.

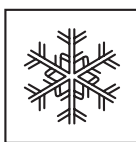

- INGELIVO
- FROST RESISTANT
- INGÉLIF
- FROSTBESTÄNDIG
- RESISTENTE A LA HELADA



- ELEVATA RESISTENZA AI CARICHI STATICI
- HIGH STATIC LOAD RESISTANCE
- RÉSISTANCE ÉLEVÉE AUX CHARGES STATIQUES
- HOHE STATISCHE BELASTBARKEIT
- ELEVADA RESISTENCIA A LAS CARGAS ESTÁTICAS



- FACILE DA POSARE
- EASY TO INSTALL
- FACILE À POSER
- VERLEGELEICHT
- FÁCIL DE COLOCAR



- ANTISCIVOLO R11
- ANTI SLIP R11
- ANTIDÉRAPANT R11
- RUTSCHFEST R11
- ANTIDESLIZANTE R11

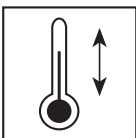

- RESISTENTE AGLI SBALZI TERMICI
- THERMAL SHOCK RESISTANT
- RÉSISTANT AUX ÉCARTS THERMIQUES
- TEMPERATURWECHSELBESTÄNDIG
- RESISTENTE A LAS OSCILACIONES TÉRMICAS



- FACILE DA PULIRE
- EASY TO CLEAN
- FACILE À NETTOYER
- REINIGUNGSLEICHT
- FÁCIL DE LIMPIAR

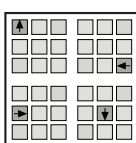

- RIMOVIBILE E RIUTILIZZABILE
- REMOVABLE AND REUSABLE
- DÉMONTABLE ET RÉUTILISABLE
- ENTFERNBAR UND WIEDERVERWENDBAR
- DESMONTABLE Y REUTILIZABLE



- INATTACCABILE DA AGENTI CHIMICI E MUFFE
- IMPERVIOUS TO ATTACK BY CHEMICALS OR MOULD
- RÉSISTANT AUX AGENTS CHIMIQUES ET AUX MOISSISSURES
- UNANGREIFBAR DURCH CHEMISCHE STOFFE UND SCHIMMEL
- RESISTENTE A LOS AGENTES QUÍMICOS Y A LOS MOHOS

## Applicazioni - Applications - Applications - Verlegung - Aplicaciones

- Posa diretta su erba
- Direct installation on grass
- Pose directe sur de l'herbe
- Verlegung direkt auf Rasen
- Colocación directa sobre hierba

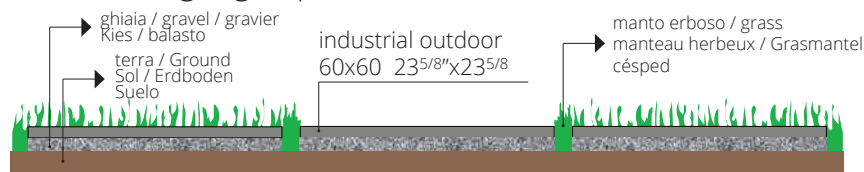

- Posa diretta su ghiaia
- Direct installation over gravel
- Pose direct sur du gravier
- Verlegung direkt auf Kies
- Colocación directa sobre grava



- Posa su massetto cementizio
- Installation on sand-cement screed
- Pose sur chape ciment
- Verlegung auf Zement-Unterbetonblock
- Colocación sobre contrapiso de hormigón

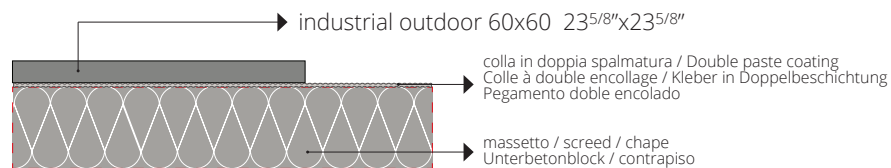

- Posa su piedini fissi o regolabili
- Installation on fixed or adjustable feet
- Pose sur pieds fixes ou réglables
- Verlegung auf feststehende oder regulierbare Füße
- Colocación sobre pies fijos o regulables

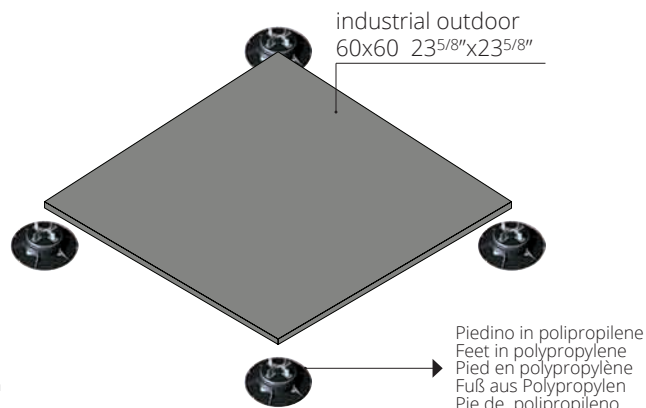

Per le specifiche di utilizzo dei sistemi sopraelevati vedi il sito [florim.com](http://florim.com)  
For the specifics on use of raised systems visit the site [florim.com](http://florim.com)  
Pour les caractéristiques d'utilisation des systèmes surélevés, voir le site [florim.com](http://florim.com)  
Für die Nutzungsbedingungen der Doppelbodensysteme siehe Webseite [florim.com](http://florim.com)  
Para las especificaciones de empleo de los sistemas sobreelevados consulte el sitio web [florim.com](http://florim.com)

Le lastre ceramiche sono sottoposte a un trattamento di compattazione termica che assicura resistenza e durata nel tempo. Il bassissimo assorbimento d'acqua rende perciò il materiale ingelivo. Ciò può comportare ristagni d'acqua superficiali anche per materiale installato a regola d'arte. / Ceramic tiles undergo a compacting thermal treatment that ensures resistance and durability. The low level of water absorption makes the slabs frost resistant. This could result in superficial water stagnations even if materials are installed in a workmanlike manner. / Les carreaux de céramique subissent un traitement thermique de compactage qui assure résistance et durabilité. Le faible niveau d'absorption d'eau rend les dalles résistantes au gel. Il pourrait en résulter des stagnations d'eau superficielles, même si les dalles ont été installées dans les règles de l'art. / Die Keramikplatten werden einer thermischen Verdichtung unterzogen, welche die Widerstandsfähigkeit und Langlebigkeit sichert. Die extrem niedrige Wasseraufnahme macht das Material frostsicher. Die hohe Materialdichte kann, auch bei einer perfekten Verlegung, eine längere Abtrocknungszeit von angestaumtem Wasser zur Folge haben. / Las baldosas cerámicas se someten a un tratamiento de compactación térmica que asegura resistencia y durabilidad. La baja absorción de agua hace que las baldosas resistan al hielo. Esto podría resultar en estancamientos superficiales de agua, incluso si los materiales están instalados según las reglas del arte.

## IVORY



## TAUPE



**R11**  
CLASSE C

DCOF >  
0,42 Wet

20 mm 3/4" ↑↓

## MOKA

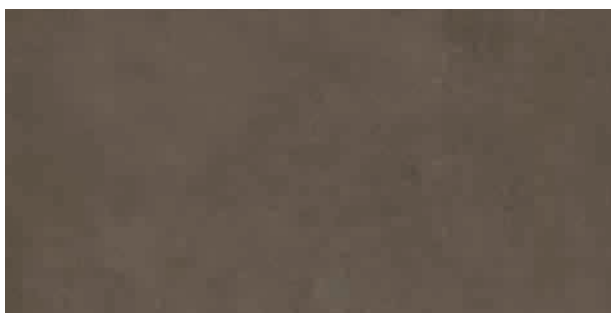

## SAGE



## STEEL

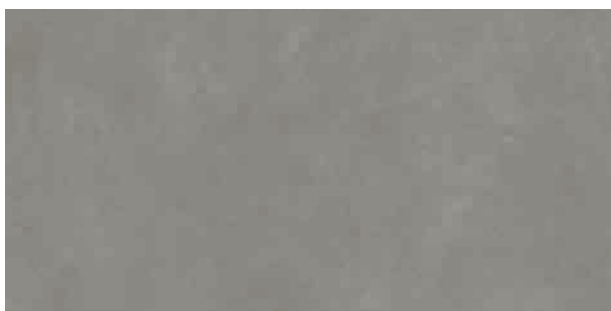

## PLOMB



### GRES FINE PORCELLANATO

FINE PORCELAIN STONWARE/GRES CERAME FIN/FEINSTEINZEUG-KOLLEKTIONEN/GRES PORCELANICO FINO  
SQUADRATO - SQUARED - EQUARRI - REKTIFIZIERT - ESCUADRADO

20 mm 3/4" ↑↓

|  | COLOR | SURFACE     | 60x60<br>23 <sup>5/8</sup> "x23 <sup>5/8</sup> " |
|--|-------|-------------|--|
|  | IVORY | BOCCIARDATO | 738961   |
|  | TAUPE | BOCCIARDATO | 738964   |
|  | MOKA  | BOCCIARDATO | 738965   |
|  | SAGE  | BOCCIARDATO | 738962   |
|  | STEEL | BOCCIARDATO | 738963   |
|  | PLOMB | BOCCIARDATO | 738966   |

### INDUSTRIAL



Recycled material content certification

20mm  
STEEL - SAGE

| ISO 10545-4 | RESISTENZA ALLA FLESSIONE IN N/mm <sup>2</sup><br>N/mm <sup>2</sup> FLEXURAL STRENGTH TEST / RESISTANCE<br>A LA FLEXION EN N/mm <sup>2</sup> / BIEGEFESTIGKEIT IN<br>N/mm <sup>2</sup> / RESISTENCIA A LA FLEXION EN N/mm <sup>2</sup> | valore medio<br>52 N/mm <sup>2</sup> |
|-------------|--|--------------------------------------|
|             | Forza di rottura in N (sp. > 7,5 mm)<br>Breaking strength in N (thickness > 7,5 mm) / Forza de<br>ruptura en N (es. > 7,5 mm) / Bruchlast in N (Dicke ><br>7,5 mm) / Fuerza de rotura en N (gr. > 7,5 mm)                              | valore medio<br>14000 N              |

### PEZZI SPECIALI

Special trims/Pièces spéciales/Formstücke  
Piezas especiales  
pag 152/155

| INDUSTRIAL | scatola - box |      |       | pallet |       |     |
|------------|---------------|------|-------|--------|-------|-----|
|            | pz            | mq   | kg    | box    | mq    | kg  |
| 60x60 20mm | 2             | 0,72 | 32,15 | 30     | 21,60 | 990 |







# PLIMATECH

gres fine porcellanato  
fine porcelain stoneware  
grès cérame fin  
feinsteinzeug-kollektionen  
gres porcelánico fino







## PLIMATECH / PREMIUM

La naturalità del granito Plima si unisce alla versatilità del gres porcellanato Florim. Dalle alture della Val Martello in Alto Adige nasce l'ispirazione di **Plimatech** dell'Architectural design. Modellata su una varietà di granito chiamato Plima, la collezione unisce ai vantaggi tecnico-progettuali del gres porcellanato l'aspetto naturale e la struttura di una pietra estremamente rara dalla particolare texture mossa con brillanti formazioni cristalline e screziature chiaro-scure. Plimatech presenta tre differenti colorazioni aggiungendo alla tipica tonalità grigio-azzurra del granito Plima altre due proposte cromatiche, una sui toni del bianco e l'altra su quelli del beige. L'eterogeneità estetica caratteristica della pietra naturale viene reinterpretata attraverso tre varianti grafiche con diversi gradi di stonizzazione.

The naturalness of Plima granite combines with the versatility of Florim porcelain stoneware. The inspiration for **Plimatech** Architectural design comes from high up in the Martell Valley of the Alto Adige region. Modeled on a variety of granite called Plima, the collection combines the technical and design advantages of porcelain stoneware, and the natural appearance and structure of an extremely rare stone featuring a distinctive wavy texture, with brilliant crystal formations and light-dark mottling. Plimatech comes in three different colors, adding two more schemes to the typical gray-blue shade of Plima granite, one in white, the other in beige. The aesthetic heterogeneity characteristic of natural stone is reinterpreted through three graphic variants with different degrees of tonal variation.

Le naturel du granit Plima se marie à la polyvalence du grès cérame Florim. **Plimatech** de l'Architectural design puise son inspiration dans les hauteurs du Val Martello dans le Haut-Adige. Façonnée à partir d'une variété de granit appelée Plima, la collection allie les avantages techniques et conceptuels du grès cérame à l'aspect naturel et à la structure d'une pierre extrêmement rare, à la texture particulière, ondulée et agrémentée de formations cristallines brillantes et de marbrures claires et sombres. Plimatech présente trois couleurs différentes : deux propositions chromatiques, l'une avec des tonalités blanches et l'autre avec des nuances beiges, s'ajoutent au ton caractéristique gris-bleu ciel du granit Plima. L'hétérogénéité esthétique qui distingue la pierre naturelle est réinterprétée à travers trois variantes graphiques offrant différents niveaux de stonisation.

Die Natürlichkeit des Granits Plima verbindet sich mit der Vielseitigkeit des Feinsteinzeugs Florim. Aus den Höhen des Martelltals in Südtirol kommt die Inspiration für **Plimatech** Architectural Design. Die einer Granitart namens Plima nachempfundene Kollektion verbindet die technischen und gestalterischen Vorteile von Feinsteinzeug mit dem natürlichen Aussehen und der Struktur eines seltenen Gesteins, das sich durch eine unverwechselbare gewellte Textur mit glänzenden Kristallformationen und Hell-Dunkel-Sprenkeln auszeichnet. Plimatech ist in drei verschiedenen Farben erhältlich, wobei zum typischen graublauen Farbton des Plima-Granits zwei weitere Schattierungen hinzukommen, eine in Weiß- und eine in Beigetönen. Die für Naturstein charakteristische ästhetische Heterogenität wird durch drei grafische Varianten mit unterschiedlichen Schattierungsgraden neu interpretiert.

La naturalidad del granito Plima se une a la versatilidad del gres porcelánico Florim. La inspiración de **Plimatech** de Architectural design tiene su origen en las alturas de Val Martello, en Alto Adigio. Modelada en una variedad de granito llamada Plima, la colección aúna las ventajas técnico-proyectuales del gres porcelánico y la estructura y el aspecto natural de una piedra sumamente peculiar, dotada de un textura especial y animada con brillantes formaciones cristalinias y venas claroscuros. Plimatech presenta tres colores distintos, añadiendo otras dos propuestas cromáticas a la típica tonalidad gris-celeste del granito Plima: una en tonos blancos y otra en gradaciones beige. La heterogeneidad estética característica de la piedra natural se reinterpreta a través de tres variantes gráficas con diferentes grados de destonización.



# PLIMATECH / PREMIUM

## PLIMAWHITE/01



## PLIMAWHITE/02



**R10**  
**Classe B**  
(naturale/  
matte)

BS EN 16165  
ANNEX C  
>36 wet  
slider 96  
(naturale/  
matte)

**R11**  
**Classe C**  
(strutturato)

DCOF>  
0,42 Wet

9 mm 3/8" ↑↓



**R10**  
**Classe B**

BS EN 16165  
ANNEX C  
>36 wet  
slider 96

DCOF>  
0,42 Wet

6 mm 1/4" ↑↓



**GRES FINE PORCELLANATO**  
FINE PORCELAIN STONEWARE / GRÈS CÉRAMÉ FIN / FEINSTEINZEUG-KOLLEKTIONEN / GRES PORCELÁNICO FINO  
SQUADRATO - SQUARED - EQUARRI - REKTIFIZIERT - ESCUADRADO

| 9 mm 3/8" ↑↓     |  | COLOR         | SURFACE        | 60x120<br>23 <sup>5/8"</sup> x47 <sup>1/4"</sup> | 60x60<br>23 <sup>5/8"</sup> x23 <sup>5/8"</sup> | 30x60<br>11 <sup>4/5"</sup> x23 <sup>5/8"</sup> |
|------------------|--|---------------|----------------|--|---|---|
| <b>PLIMATECH</b> |  | PLIMAWHITE/01 | NATURALE/MATTE | 776566   | 776506  | 776496  |
|                  |  |               | STRUTTURATO    | 776658   | -   | -   |
|                  |  | PLIMAWHITE/02 | NATURALE/MATTE | 776569   | 776507  | 776497  |
|                  |  |               | STRUTTURATO    | 776659   | -   | -   |

| 6 mm 1/4" ↑↓     |  | COLOR         | SURFACE        | 120x280<br>47 <sup>1/4"</sup> x110 <sup>1/4"</sup> | 120x240<br>47 <sup>1/4"</sup> x94 <sup>1/2"</sup> | 120x120<br>47 <sup>1/4"</sup> x47 <sup>1/4"</sup> | 60x120<br>23 <sup>5/8"</sup> x47 <sup>1/4"</sup> |
|------------------|--|---------------|----------------|--|---|---|--|
| <b>PLIMATECH</b> |  | PLIMAWHITE/01 | NATURALE/MATTE | 776410   | 776549  | 776558  | 776577   |
|                  |  |               | NATURALE/MATTE | 776412   | 776550  | 776559  | 776578   |
|                  |  | PLIMAWHITE/02 | NATURALE/MATTE | 776412   | 776550  | 776559  | 776578   |
|                  |  |               | NATURALE/MATTE | 776412   | 776550  | 776559  | 776578   |



## PLIMAWHITE/03



**R10**  
**Classe B**  
(naturale/  
matte)

BS EN 16165  
ANNEX C  
>36 wet  
slider 96  
(naturale/  
matte)

**R11**  
**Classe C**  
(strutturato)

DCOF>  
0,42 Wet

9 mm 3/8" ↑↓



**R10**  
**Classe B**

BS EN 16165  
ANNEX C  
>36 wet  
slider 96

DCOF>  
0,42 Wet

6 mm 1/4" ↑↓

FLORIM OVERSIZE  
**magnum**

**GRES FINE PORCELLANATO**  
FINE PORCELAIN STONEWARE / GRÈS CÉRAMÉ FIN / FEINSTEINZEUG-KOLLEKTIONEN / GRES PORCELÁNICO FINO  
SQUADRATO - SQUARED - EQUARRI - REKTIFIZIERT - ESCUADRADO

|                  |  | COLOR         | SURFACE        | 60x120<br>23 <sup>5/8"</sup> x47 <sup>1/4"</sup> | 60x60<br>23 <sup>5/8"</sup> x23 <sup>5/8"</sup> | 30x60<br>11 <sup>4/5"</sup> x23 <sup>5/8"</sup> |
|------------------|--|---------------|----------------|--|---|---|
| <b>PLIMATECH</b> |  | PLIMAWHITE/03 | NATURALE/MATTE | 776570   | 776508  | 776498  |
|                  |  |               | STRUTTURATO    | 776660   | -   | -   |

|                  |  | COLOR         | SURFACE        | 120x280<br>47 <sup>1/4"</sup> x110 <sup>1/4"</sup> | 120x240<br>47 <sup>1/4"</sup> x94 <sup>1/2"</sup> | 120x120<br>47 <sup>1/4"</sup> x47 <sup>1/4"</sup> | 60x120<br>23 <sup>5/8"</sup> x47 <sup>1/4"</sup> |
|------------------|--|---------------|----------------|--|---|---|--|
| <b>PLIMATECH</b> |  | PLIMAWHITE/03 | NATURALE/MATTE | 776413   | 776551  | 776560  | 776579   |

# PLIMATECH / PREMIUM

## PLIMABEIGE/01



## PLIMABEIGE/02



**R10**  
**Classe B**  
(naturale/  
matte)

BS EN 16165  
ANNEX C  
>36 wet  
slider 96  
(naturale/  
matte)

**R11**  
**Classe C**  
(strutturato)

DCOF>  
0,42 Wet

9 mm 3/8" ↑↓



**R10**  
**Classe B**

BS EN 16165  
ANNEX C  
>36 wet  
slider 96

DCOF>  
0,42 Wet

6 mm 1/4" ↑↓

FLORIM OVERSIZE  
**magnuM**

### GRES FINE PORCELLANATO

FINE PORCELAIN STONEWARE / GRÈS CÉRAME FIN / FEINSTEINZEUG-KOLLEKTIONEN / GRES PORCELÁNICO FINO

SQUADRATO - SQUARED - EQUARRI - REKTIFIZIERT - ESCUADRADO

| 9 mm 3/8" ↑↓     |  | COLOR         | SURFACE        | 60x120<br>23 <sup>5/8"</sup> x47 <sup>1/4"</sup> | 60x60<br>23 <sup>5/8"</sup> x23 <sup>5/8"</sup> | 30x60<br>11 <sup>4/5"</sup> x23 <sup>5/8"</sup> |
|------------------|--|---------------|----------------|--|---|---|
| <b>PLIMATECH</b> |  | PLIMABEIGE/01 | NATURALE/MATTE | 776571   | 776509  | 776499  |
|                  |  |               | STRUTTURATO    | 776661   | -   | -   |
|                  |  | PLIMABEIGE/02 | NATURALE/MATTE | 776572   | 776510  | 776500  |
|                  |  |               | STRUTTURATO    | 776662   | -   | -   |

| 6 mm 1/4" ↑↓     |  | COLOR         | SURFACE        | 120x280<br>47 <sup>1/4"</sup> x110 <sup>1/4"</sup> | 120x240<br>47 <sup>1/4"</sup> x94 <sup>1/2"</sup> | 120x120<br>47 <sup>1/4"</sup> x47 <sup>1/4"</sup> | 60x120<br>23 <sup>5/8"</sup> x47 <sup>1/4"</sup> |
|------------------|--|---------------|----------------|--|---|---|--|
| <b>PLIMATECH</b> |  | PLIMABEIGE/01 | NATURALE/MATTE | 776414   | 776552  | 776561  | 776580   |
|                  |  | PLIMABEIGE/02 | NATURALE/MATTE | 776415   | 776553  | 776562  | 776581   |



## PLIMABEIGE/03



**R10**  
**Classe B**  
(naturale/  
matte)

BS EN 16165  
ANNEX C  
>36 wet  
slider 96  
(naturale/  
matte)

**R11**  
**Classe C**  
(strutturato)

DCOF>  
0,42 Wet

**9 mm** 3/8" ↑↓



**R10**  
**Classe B**

BS EN 16165  
ANNEX C  
>36 wet  
slider 96

DCOF>  
0,42 Wet

**6 mm** 1/4" ↑↓

FLORIM OVERSIZE  
**magnum**

**GRES FINE PORCELLANATO**  
FINE PORCELAIN STONEWARE / GRÈS CÉRAMÉ FIN / FEINSTEINZEUG-KOLLEKTIONEN / GRES PORCELÁNICO FINO  
SQUADRATO - SQUARED - EQUARRI - REKTIFIZIERT - ESCUADRADO

|                     |                  |   |               | <b>60x120</b><br>23 <sup>5/8"</sup> x47 <sup>1/4"</sup> | <b>60x60</b><br>23 <sup>5/8"</sup> x23 <sup>5/8"</sup> | <b>30x60</b><br>11 <sup>4/5"</sup> x23 <sup>5/8"</sup> |        |
|---------------------|------------------|---|---------------|---|--|--|--------|
| <b>9 mm</b> 3/8" ↑↓ | <b>PLIMATECH</b> |  | PLIMABEIGE/03 | NATURALE/MATTE  | 776573   | 776511   | 776501 |
|                     |                  |   |               | STRUTTURATO   | 776663   | -  | -      |

|                     |                  |   |               | <b>120x280</b><br>47 <sup>1/4"</sup> x110 <sup>1/4"</sup> | <b>120x240</b><br>47 <sup>1/4"</sup> x94 <sup>1/2"</sup> | <b>120x120</b><br>47 <sup>1/4"</sup> x47 <sup>1/4"</sup> | <b>60x120</b><br>23 <sup>5/8"</sup> x47 <sup>1/4"</sup> |        |
|---------------------|------------------|---|---------------|---|--|--|---|--------|
| <b>6 mm</b> 1/4" ↑↓ | <b>PLIMATECH</b> |  | PLIMABEIGE/03 | NATURALE/MATTE  | 776416   | 776554   | 776563  | 776582 |

# PLIMATECH / PREMIUM

## PLIMAGRAY/01



## PLIMAGRAY/02



**R10**  
**Classe B**  
(naturale/  
matte)

BS EN 16165  
ANNEX C  
>36 wet  
slider 96  
(naturale/  
matte)

**R11**  
**Classe C**  
(strutturato)

DCOF>  
0,42 Wet

9 mm 3/8" ↑↓



**R10**  
**Classe B**

BS EN 16165  
ANNEX C  
>36 wet  
slider 96

DCOF>  
0,42 Wet

6 mm 1/4" ↑↓

FLORIM OVERSIZE  
**magnum**

### GRES FINE PORCELLANATO

FINE PORCELAIN STONEWARE / GRÈS CÉRAME FIN / FEINSTEINZEUG-KOLLEKTIONEN / GRES PORCELÁNICO FINO

SQUADRATO - SQUARED - EQUARRI - REKTIFIZIERT - ESCUADRADO

9 mm 3/8" ↑↓

|                  | COLOR        | SURFACE        | 60x120<br>23 <sup>5/8"</sup> x47 <sup>1/4"</sup> | 60x60<br>23 <sup>5/8"</sup> x23 <sup>5/8"</sup> | 30x60<br>11 <sup>4/5"</sup> x23 <sup>5/8"</sup> |
|------------------|--------------|----------------|--|---|---|
| <b>PLIMATECH</b> | PLIMAGRAY/01 | NATURALE/MATTE | 776574   | 776513  | 776502  |
|                  |              | STRUTTURATO    | 776664   | -   | -   |
| <b>PLIMATECH</b> | PLIMAGRAY/02 | NATURALE/MATTE | 776575   | 776514  | 776503  |
|                  |              | STRUTTURATO    | 776665   | -   | -   |

6 mm 1/4" ↑↓

|                  | COLOR        | SURFACE        | 120x280<br>47 <sup>1/4"</sup> x110 <sup>1/4"</sup> | 120x240<br>47 <sup>1/4"</sup> x94 <sup>1/2"</sup> | 120x120<br>47 <sup>1/4"</sup> x47 <sup>1/4"</sup> | 60x120<br>23 <sup>5/8"</sup> x47 <sup>1/4"</sup> |
|------------------|--------------|----------------|--|---|---|--|
| <b>PLIMATECH</b> | PLIMAGRAY/01 | NATURALE/MATTE | 776417   | 776555  | 776565  | 776583   |
|                  |              | PLIMAGRAY/02   | NATURALE/MATTE                                     | 776418  | 776556  | 776567   |



## PLIMAGRAY/03



**R10**  
**Classe B**  
(naturale/  
matte)

BS EN 16165  
ANNEX C  
>36 wet  
slider 96  
(naturale/  
matte)

**R11**  
**Classe C**  
(strutturato)

DCOF>  
0,42 Wet

9 mm 3/8" ↑↓



**R10**  
**Classe B**

BS EN 16165  
ANNEX C  
>36 wet  
slider 96

DCOF>  
0,42 Wet

6 mm 1/4" ↑↓

FLORIM OVERSIZE  
**magnum**

**GRES FINE PORCELLANATO**  
FINE PORCELAIN STONEWARE / GRÈS CÉRAME FIN / FEINSTEINZEUG-KOLLEKTIONEN / GRES PORCELÁNICO FINO  
SQUADRATO - SQUARED - EQUARRI - REKTIFIZIERT - ESCUADRADO

| 9 mm 3/8" ↑↓     |  | COLOR        | SURFACE        | 60x120<br>23 <sup>5/8"</sup> x47 <sup>1/4"</sup> | 60x60<br>23 <sup>5/8"</sup> x23 <sup>5/8"</sup> | 30x60<br>11 <sup>4/5"</sup> x23 <sup>5/8"</sup> |
|------------------|--|--------------|----------------|--|---|---|
| <b>PLIMATECH</b> |  | PLIMAGRAY/03 | NATURALE/MATTE | 776576   | 776515  | 776504  |
|                  |  |              | STRUTTURATO    | 776666   | -   | -   |

| 6 mm 1/4" ↑↓     |  | COLOR        | SURFACE        | 120x280<br>47 <sup>1/4"</sup> x110 <sup>1/4"</sup> | 120x240<br>47 <sup>1/4"</sup> x94 <sup>1/2"</sup> | 120x120<br>47 <sup>1/4"</sup> x47 <sup>1/4"</sup> | 60x120<br>23 <sup>5/8"</sup> x47 <sup>1/4"</sup> |
|------------------|--|--------------|----------------|--|---|---|--|
| <b>PLIMATECH</b> |  | PLIMAGRAY/03 | NATURALE/MATTE | 776419   | 776557  | 776568  | 776585   |

# PLIMATECH / PREMIUM

## PLIMAWHITE/01

4 grafiche continue / 4 continuous pattern graphics



### Es. posa:

Il disegno riprodotto è indicativo. Come per il materiale naturale la grafica può mostrare discontinuità di vena nel passaggio da una lastra all'altra. Per questo motivo differenze fino a 1,5 cm devono essere considerate come caratteristica del prodotto; non è garantita la sequenza delle facce in fase di approntamento dell'ordine.

### Example of installation:

The drawing is indicative. As with natural material, graphics may show vein discontinuities in the transition from one slab to another. For this reason, differences of up to 1.5 cm must be considered as a product characteristic. The sequence of the faces is not guaranteed when placing the order.

|   |               |         |                            |
|---|---------------|---------|----------------------------|
| 6 mm 1/4"  | COLOR         | SURFACE | <b>160x320</b><br>63"x126" |
| PLIMATECH  | PLIMAWHITE/01 | MATTE   | 777636                     |









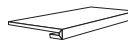

Le grafiche sopra riportate si riferiscono al formato 160x320 / The above designs refer to size 160x320 cm / Les graphismes indiqués ci-dessus se réfèrent au format 160x320  
Die oben abgebildeten Grafiken beziehen sich auf das Format 160x320 / Las gráficas arriba indicadas se refieren a la medida 160x320.

## GRES FINE PORCELLANATO

FINE PORCELAIN STONEWARE / GRÈS CÉRAMÉ FIN / FEINSTEINZEUG-KOLLEKTIONEN / GRES PORCELÁNICO FINO  
SQUADRATO - SQUARED - EQUARRI - REKTIFIZIERT - ESCUADRADO

| 9 mm 3/8" ↑↓     |   | COLOR         | SURFACE        | <b>30x60</b><br>11 4/5" x 23 5/8"<br><br>muretto 3D A+B<br><b>pz/box 4</b> |
|------------------|---|---------------|----------------|---|
|                  |  | PLIMAWHITE/02 | NATURALE/MATTE | 776729  |
| <b>PLIMATECH</b> |  | PLIMABEIGE/02 | NATURALE/MATTE | 776730  |
|                  |  | PLIMAGRAY/02  | NATURALE/MATTE | 776731  |

## PEZZI SPECIALI/SPECIAL TRIMS/PIÈCES SPÉCIALES/FORMSTÜCKE/PIEZAS ESPECIALES

| 9 mm 3/8" ↑↓     |   | COLOR         | SURFACE        | <b>4,6x60</b><br>1 4/5" x 23 5/8"<br><br>battiscopa | <b>33x120x3</b><br>13" x 47 1/4" x 1 1/8"<br><br>gradino<br><b>pz/box 2</b> |
|------------------|---|---------------|----------------|--|--|
|                  |  | PLIMAWHITE/01 | NATURALE/MATTE | 776676   | 776685   |
|                  |  | PLIMAWHITE/02 | NATURALE/MATTE | 776679   | 776688   |
|                  |  | PLIMAWHITE/03 | NATURALE/MATTE | 776682   | 776691   |
|                  |  | PLIMABEIGE/01 | NATURALE/MATTE | 776677   | 776686   |
| <b>PLIMATECH</b> |  | PLIMABEIGE/02 | NATURALE/MATTE | 776680   | 776689   |
|                  |  | PLIMABEIGE/03 | NATURALE/MATTE | 776683   | 776692   |
|                  |  | PLIMAGRAY/01  | NATURALE/MATTE | 776678   | 776687   |
|                  |  | PLIMAGRAY/02  | NATURALE/MATTE | 776681   | 776690   |
|                  |  | PLIMAGRAY/03  | NATURALE/MATTE | 776684   | 776693   |





**Per un effetto ottimale della posa, Florim suggerisce di mantenere 2 mm di fuga per pose monoformato e 3 mm per combinare formati misti** - For optimal installation results, Florim recommends maintaining a joint of 2 mm 1/12" for single format installations and 3 mm 1/8" to combine mixed formats. - Pour réaliser une pose parfait, Florim conseille de laisser 2 mm de joint pour la pose des monoformats et 3 mm pour les combinaisons de formats mixtes. - Um einen optimalen effekt beim verlegen zu erzielen empfiehlt Florim eine 2 mm fugе bei einformatigen verlegungen und 3 mm fugе bei formatkombinationen - Para lograr los máximos resultados en la posa del producto, Florim aconseja 2 mm de junta en aplicaciones monoformato y 3 mm en combinaciones de formatos mixtos

**In relazione alle differenti tecnologie produttive l'accostamento di prodotti con spessori diversi potrebbe presentare delle disomogeneità, se ne sconsiglia pertanto l'abbinamento.** / Due to the different production technologies, contiguous installation of products with different thickness may give a non-homogeneous result. For this reason we do not recommend this option. / Vu que différentes technologies de production sont utilisées avec des épaisseurs différentes, des problèmes d'homogénéité pourraient se présenter, il est donc déconseillé de les poser ensemble. / Wegen unterschiedlicher Produktionstechnologien können die Fliesen mit verschiedenen Materialstärken optische Differenzen aufweisen. Von einem direkten Aneinanderlegen wird deshalb abgeraten. / Dadas las diferentes tecnologías productivas, la combinación de productos de diferentes espesores podría dar lugar a heterogeneidad, por lo que se desaconseja mezclarlas.









# PLIMATECH / PREMIUM

## GRES FINE PORCELLANATO

FINE PORCELAIN STONEWARE / GRÈS CÉRAMÉ FIN / FEINSTEINZEUG-KOLLEKTIONEN / GRES PORCELÁNICO FINO  
SQUADRATO - SQUARED - EQUARRI - REKTIFIZIERT - ESCUADRADO

| 6 mm 1/4" ↑↓  | COLOR         | SURFACE        | 30x60<br>11 4/5" x 23 5/8" | 30x34<br>11 4/5" x 13 2/5" |
|---|---------------|----------------|----------------------------|----------------------------|
|   |               |                | muretto<br>pz/box 6        | HIVE<br>pz/box 10          |
|  | PLIMAWHITE/02 | NATURALE/MATTE | 776704                     | 776709                     |
| <b>PLIMATECH</b>  |               |                |                            |                            |
|  | PLIMABEIGE/02 | NATURALE/MATTE | 776705                     | 776710                     |
|  | PLIMAGRAY/02  | NATURALE/MATTE | 776706                     | 776711                     |

## PEZZI SPECIALI/SPECIAL TRIMS/PIÈCES SPÉCIALES/FORMSTÜCKE/PIEZAS ESPECIALES

| 6 mm 1/4" ↑↓  | COLOR         | SURFACE           | 4,6x60<br>1 4/5" x 23 5/8" |
|---|---------------|-------------------|----------------------------|
|   |               |                   | battiscopa                 |
|  | PLIMAWHITE/01 | NATURALE/MATTE    | 776695                     |
|  | PLIMAWHITE/02 | NATURALE/MATTE    | 776698                     |
|  | PLIMAWHITE/03 | NATURALE/MATTE    | 776701                     |
|  | PLIMABEIGE/01 | NATURALE/MATTE    | 776696                     |
| <b>PLIMATECH</b>  |               |                   |                            |
|  | PLIMABEIGE/02 | NATURALE/MATTE    | 776699                     |
|  | PLIMABEIGE/03 | NATURALE/MATTE    | 776702                     |
|  | PLIMAGRAY/01  | NATURALE<br>MATTE | 776697                     |
|  | PLIMAGRAY/02  | NATURALE<br>MATTE | 776700                     |
|  | PLIMAGRAY/03  | NATURALE<br>MATTE | 776703                     |

FLORM OVERSIZE  
**magnUm**

**160x320/120x280/120x240/120x120/60x120**  
Specifica Imballo pag.  
Packaging specifications on page  
Spécifications d'emballage à page  
Verpackungsdetail Seite  
Especificaciones de embalaje a la página  
**162/163**

| PLIMATECH | scatola - box |      |       | pallet |       |     |
|-----------|---------------|------|-------|--------|-------|-----|
|           | pz            | mq   | kg    | box    | mq    | kg  |
| 60x120    | 2             | 1,44 | 27,73 | 30     | 43,20 | 860 |
| 60x60     | 3             | 1,08 | 21,49 | 40     | 43,20 | 880 |
| 30x60     | 6             | 1,08 | 21,49 | 40     | 43,20 | 880 |

| PLIMATECH         | scatola - box |      |      | pallet |    |    |
|-------------------|---------------|------|------|--------|----|----|
|                   | pz            | ml   | kg   | box    | mq | kg |
| 4,6x60 battiscopa | 14            | 8,40 | 8,40 | -      | -  | -  |





# PLIMATECH OUTDOOR / PREMIUM

## Vantaggi tecnici - Technical advantages - Avantages techniques Technische Vorteile - Ventajas técnicas

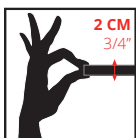

- Lastra monolitica compatta di spessore 2 cm squadrata e rettificata
- Compact monolithic slab 2 cm thick squared and rectified
- Dalle monolithique compacte de 2 cm d'épaisseur, équarrie et rectifiée
- Kompakte monolithische Platte, 2 cm dick, rechteckig und scharfkantig geschliffen
- Losa monolítica compacta de 2 cm de espesor, escuadrada y rectificada.

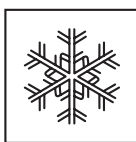

- INGELIVO
- FROST RESISTANT
- INGÉLIF
- FROSTBESTÄNDIG
- RESISTENTE A LA HELADA



- ELEVATA RESISTENZA AI CARICHI STATICI
- HIGH STATIC LOAD RESISTANCE
- RÉSISTANCE ÉLEVÉE AUX CHARGES STATIQUES
- HOHE STATISCHE BELASTBARKEIT
- ELEVADA RESISTENCIA A LAS CARGAS ESTÁTICAS



- FACILE DA POSARE
- EASY TO INSTALL
- FACILE À POSER
- VERLEGELEICHT
- FÁCIL DE COLOCAR



- ANTISCIVOLO R11
- ANTI SLIP R11
- ANTIDÉRAPANT R11
- RUTSCHFEST R11
- ANTIDESLIZANTE R11

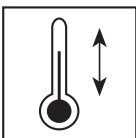

- RESISTENTE AGLI SBALZI TERMICI
- THERMAL SHOCK RESISTANT
- RÉSISTANT AUX ÉCARTS THERMIQUES
- TEMPERATURWECHSELBESTÄNDIG
- RESISTENTE A LAS OSCILACIONES TÉRMICAS



- FACILE DA PULIRE
- EASY TO CLEAN
- FACILE À NETTOYER
- REINIGUNGSLEICHT
- FÁCIL DE LIMPIAR

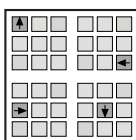

- RIMOVIBILE E RIUTILIZZABILE
- REMOVABLE AND REUSABLE
- DÉMONTABLE ET RÉUTILISABLE
- ENTFERNBAR UND WIEDERVERWENDBAR
- DESMONTABLE Y REUTILIZABLE



- INATTACCABILE DA AGENTI CHIMICI E MUFFE
- IMPERVIUS TO ATTACK BY CHEMICALS OR MOULD
- RÉSISTANT AUX AGENTS CHIMIQUES ET AUX MOISSISSURES
- UNANGREIFBAR DURCH CHEMISCHE STOFFE UND SCHIMMEL
- RESISTENTE A LOS AGENTES QUÍMICOS Y A LOS MOHOS

## Applicazioni - Applications - Applications - Verlegung - Aplicaciones

- Posa diretta su erba
- Direct installation on grass
- Pose directe sur de l'herbe
- Verlegung direkt auf Rasen
- Colocación directa sobre hierba

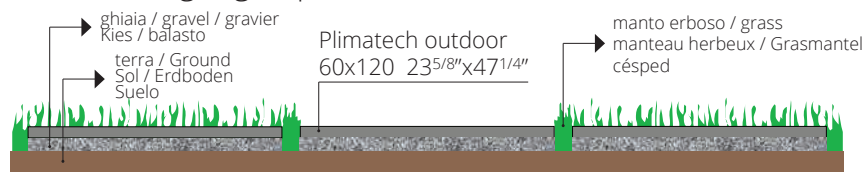

- Posa diretta su ghiaia
- Direct installation over gravel
- Pose direct sur du gravier
- Verlegung direkt auf Kies
- Colocación directa sobre grava



- Posa su massetto cementizio
- Installation on sand-cement screed
- Pose sur chape ciment
- Verlegung auf Zement-Unterbetonblock
- Colocación sobre contrapiso de hormigón

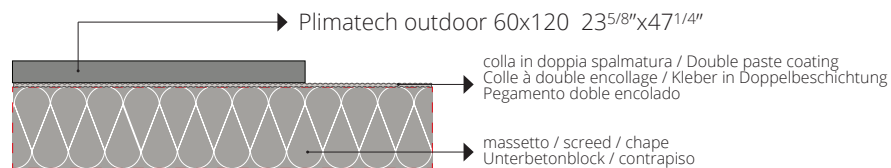

- Posa su piedini fissi o regolabili
- Installation on fixed or adjustable feet
- Pose sur pieds fixes ou réglables
- Verlegung auf feststehende oder regulierbare Füße
- Colocación sobre pies fijos o regulables

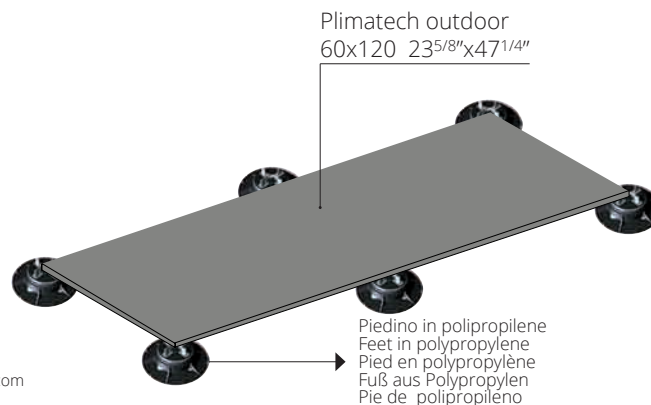

Per le specifiche di utilizzo dei sistemi sopraelevati vedi il sito florim.com  
For the specifics on use of raised systems visit the site florim.com  
Pour les caractéristiques d'utilisation des systèmes surélevés, voir le site florim.com  
Für die Nutzungsbedingungen der Doppelbodensysteme siehe Webseite florim.com  
Para las especificaciones de empleo de los sistemas sobreelevados consulte el sitio web florim.com

Le lastre ceramiche sono sottoposte a un trattamento di compattazione termica che assicura resistenza e durata nel tempo. Il bassissimo assorbimento d'acqua rende perciò il materiale ingelivo. Ciò può comportare ristagni d'acqua superficiali anche per materiale installato a regola d'arte. / Ceramic tiles undergo a compacting thermal treatment that ensures resistance and durability. The low level of water absorption makes the slabs frost resistant. This could result in superficial water stagnations even if materials are installed in a workmanlike manner. / Les carreaux de céramique subissent un traitement thermique de compactage qui assure résistance et durabilité. Le faible niveau d'absorption d'eau rend les dalles résistantes au gel. Il pourrait en résulter des stagnations d'eau superficielles, même si les dalles ont été installées dans les règles de l'art. / Die Keramikplatten werden einer thermischen Verdichtung unterzogen, welche die Widerstandsfähigkeit und Langlebigkeit sichert. Die extrem niedrige Wasseraufnahme macht das Material frostsicher. Die hohe Materialdichte kann, auch bei einer perfekten Verlegung, eine längere Abtrochnungszeit von angestaumtem Wasser zur Folge haben. / Las baldosas cerámicas se someten a un tratamiento de compactación térmica que asegura resistencia y durabilidad. La baja absorción de agua hace que las baldosas resistan al hielo. Esto podría resultar en estancamientos superficiales de agua, incluso si los materiales están instalados según las reglas del arte.



## PLIMAWHITE/02



## PLIMABEIGE/02



**R11  
CLASSE C**

DCOF >  
0,42 Wet

20 mm 3/4" ↑↓



## PLIMAGRAY/02



### GRES FINE PORCELLANATO

FINE PORCELAIN STONEWARE/GRES CERAME FIN/FEINSTEINZEUG-KOLLEKTIONEN/GRES PORCELANICO FINO  
SQUADRATO - SQUARED - EQUARRI - REKTIFIZIERT - ESCUADRADO

20 mm 3/4" ↑↓

|   | COLOR         | SURFACE     | 60x120<br>23 <sup>5/8"</sup> x47 <sup>1/4"</sup> |
|---|---------------|-------------|--|
|  | PLIMAWHITE/02 | STRUTTURATO | 776401   |
|  | PLIMABEIGE/02 | STRUTTURATO | 776404   |
|  | PLIMAGRAY/02  | STRUTTURATO | 776407   |

### PLIMATECH



Recycled material content certification

| ISO 10545-4   | RESISTENZA ALLA FLESSIONE IN N/mm <sup>2</sup><br>N/mm <sup>2</sup> FLEXURAL STRENGTH TEST / RESISTANCE<br>A LA FLEXION EN N/mm <sup>2</sup> / BIEGEFESTIGKEIT IN<br>N/mm <sup>2</sup> / RESISTENCIA A LA FLEXION EN N/mm <sup>2</sup> | valore medio<br>52 N/mm <sup>2</sup> |
|---|--|--------------------------------------|
|  | Forza di rottura in N (sp. > 7,5 mm)<br>Breaking strength in N (sp. > 7,5 mm) / Fuerza de<br>ruptura en N (sp. > 7,5 mm) / Bruchlast in N (Dicke ><br>7,5 mm) / Fuerza de rotura en N (gr. > 7,5 mm)                                   | valore medio<br>14000 N              |

| PLIMATECH   | scatola - box |      |       | pallet |       |      |
|-------------|---------------|------|-------|--------|-------|------|
|             | pz            | mq   | kg    | box    | mq    | kg   |
| 60x120 20mm | 1             | 0,72 | 32,26 | 30     | 21,60 | 1000 |

**PEZZI SPECIALI**  
Special trims/Pièces spéciales/Formstücke  
pag 152/155







# RAWTECH

gres fine porcellanato  
fine porcelain stoneware  
grès cérame fin  
feinsteinzeug-kollektionen  
gres porcelánico fino





## RAWTECH / PREMIUM

Un cemento vissuto, usurato dal tempo in cui l'imperfezione diventa il segno distintivo. **Rawtech** è il frutto di un atteggiamento progettuale che vuole recuperare il carattere identitario di un prodotto marcatamente industriale per riportarlo con gusto contemporaneo alle esigenze dell'abitare più sofisticato. Un cemento vissuto, usurato dal tempo in cui l'imperfezione diventa il segno distintivo e requisito fondamentale per esprimere al meglio uno stile inconfondibile.

**Rawtech** is the result of a design approach which aims to recapture the true identity of an essentially industrial product and at the same time appeal to the sophisticated demands of contemporary living styles. A tile with experience, worn by time, where imperfection becomes a hallmark, a prerequisite to better express its truly unmistakable style.

**Rawtech** est le fruit d'une réflexion en matière de conception qui vise à se réappropriier le caractère identitaire d'un produit résolument industriel pour le rapprocher, dans un style contemporain, des exigences d'un habitat plus sophistiqué. Un ciment ancien, usé par le passage du temps, où l'imperfection est un signe distinctif et un prérequis fondamental pour exprimer au mieux un style unique.

**Rawtech** ist das Ergebnis eines Designerstils, der die Identitätseigenschaften eines ausgesprochen industriellen Produkts zurückgewinnen und sie an die Bedürfnisse eines zeitgenössischen, anspruchsvolleren Wohnens anpassen möchte. Eine gelebte, mit der Zeit abgenutzte Fliese mit Betoneffekt, auf der die Unvollkommenheit zum Kennzeichen und damit zur Grundvoraussetzung eines unvergleichlichen Stils wird.

**Rawtech** es fruto de un planteamiento proyectual que desea recuperar el carácter identificador de un producto fuertemente industrial para satisfacer con gusto contemporáneo las necesidades de la vivienda más sofisticada. Un cemento para disfrutar, gastado por el tiempo, en el que la imperfección se convierte en signo distintivo y requisito fundamental para expresar lo mejor posible un estilo inconfundible.

# RAWTECH / PREMIUM

## RAW-WHITE



## RAW-MUD



**V2**  
RAW-WHITE

**V3**  
RAW-MUD

**R10**  
Classe B  
(naturale)

**R11**  
Classe C  
(strutturato)

DCOF>  
0,42 Wet

9 mm 3/8" ↑↓

**V2**  
RAW-WHITE

**R9**  
Classe A

DCOF>  
0,42 Wet

6 mm 1/4" ↑↓

FLORIM OVERSIZE  
magnum

### GRES FINE PORCELLANATO

FINE PORCELAIN STONEWARE / GRÈS CÉRAME FIN / FEINSTEINZEUG-KOLLEKTIONEN / GRES PORCELÁNICO FINO

SQUADRATO - SQUARED - EQUARRI - REKTIFIZIERT - ESCUADRADO

| 9 mm 3/8" ↑↓ |           | COLOR       | SURFACE | 60x120<br>23 <sup>5/8"</sup> x47 <sup>1/4"</sup> | 80x80<br>31 <sup>1/2"</sup> x31 <sup>1/2"</sup> | 60x60<br>23 <sup>5/8"</sup> x23 <sup>5/8"</sup> | 30x60<br>11 <sup>4/5"</sup> x23 <sup>5/8"</sup> |
|--------------|-----------|-------------|---------|--|---|---|---|
| RAWTECH      | RAW-WHITE | NATURALE    |         | 752196   | 752188  | 752200  | 752204  |
|              |           | STRUTTURATO |         | -  | -   | 753922  | 752208  |
|              | RAW-MUD   | NATURALE    |         | 752198   | 752190  | 752202  | 752206  |
|              |           | STRUTTURATO |         | -  | -   | 753923  | 752210  |

| 6 mm 1/4" ↑↓ |           | COLOR    | SURFACE | 120x240<br>47 <sup>1/4"</sup> x94 <sup>1/2"</sup> | 120x120<br>47 <sup>1/4"</sup> x47 <sup>1/4"</sup> | 60x120<br>23 <sup>5/8"</sup> x47 <sup>1/4"</sup> |
|--------------|-----------|----------|---------|---|---|--|
| RAWTECH      | RAW-WHITE | NATURALE |         | 757825  | 757821  | 757817   |



## RAW-DUST



## RAW-COAL



**V3**  
**R10**  
**Classe B**  
(naturale)

**R11**  
**Classe C**  
(strutturato)

DCOF>  
0,42 Wet

**9 mm** 3/8" ↑↓



**V3**  
**R9**  
**Classe A**



DCOF>  
0,42 Wet

**6 mm** 1/4" ↑↓

FLOHM OVERSIZE  
**magnUm**

### GRES FINE PORCELLANATO

FINE PORCELAIN STONEWARE / GRÈS CÉRAME FIN / FEINSTEINZEUG-KOLLEKTIONEN / GRES PORCELÁNICO FINO  
SQUADRATO - SQUARED - EQUARRI - REKTIFIZIERT - ESCUADRADO

| <b>9 mm</b> 3/8" ↑↓ |   | COLOR    | SURFACE     | <b>60x120</b><br>23 <sup>5/8"</sup> x47 <sup>1/4"</sup> | <b>80x80</b><br>31 <sup>1/2"</sup> x31 <sup>1/2"</sup> | <b>60x60</b><br>23 <sup>5/8"</sup> x23 <sup>5/8"</sup> | <b>30x60</b><br>11 <sup>4/5"</sup> x23 <sup>5/8"</sup> |
|---------------------|---|----------|-------------|---|--|--|--|
| <b>RAWTECH</b>      |  | RAW-DUST | NATURALE    | 752199  | 752191   | 752203   | 752207   |
|                     |   |          | STRUTTURATO | -   | -  | 753924   | 752211   |
|                     |  | RAW-COAL | NATURALE    | 752197  | 752189   | 752201   | 752205   |
|                     |   |          | STRUTTURATO | -   | -  | 753925   | 752209   |

| <b>6 mm</b> 1/4" ↑↓ |   | COLOR    | SURFACE  | <b>120x240</b><br>47 <sup>1/4"</sup> x94 <sup>1/2"</sup> | <b>120x120</b><br>47 <sup>1/4"</sup> x47 <sup>1/4"</sup> | <b>60x120</b><br>23 <sup>5/8"</sup> x47 <sup>1/4"</sup> |
|---------------------|---|----------|----------|--|--|---|
| <b>RAWTECH</b>      |  | RAW-DUST | NATURALE | 757826   | 757822   | 757818  |

# RAWTECH / PREMIUM

| 9 mm 3/8" ↑↓ | COLOR     | SURFACE  | 30x30<br>11 4/5" x 11 4/5"          | 21x40<br>8 1/4" x 15 3/4"               |
|--------------|-----------|----------|-------------------------------------|---|
|              |           |          | mosaico<br>tessere 3x3<br>pz/box 11 | modulo<br>listello sfalsato<br>pz/box 5 |
| RAWTECH      | RAW-WHITE | NATURALE | 753904                              | 752212                                  |
|              | RAW-MUD   | NATURALE | 753905                              | 752214                                  |
|              | RAW-DUST  | NATURALE | 753906                              | 752215                                  |
|              | RAW-COAL  | NATURALE | 753907                              | 752213                                  |

## PEZZI SPECIALI/SPECIAL TRIMS/PIÈCES SPÉCIALES/FORMSTÜCKE/PIEZAS ESPECIALES

| 9 mm 3/8" ↑↓ | COLOR     | SURFACE  | 4,6x60<br>1 4/5" x 23 5/8" | 33x120x3<br>13" x 47 1/4" x 1 1/8" | 33x120x3<br>13" x 47 1/4" x 1 1/8" | 33x120x3<br>13" x 47 1/4" x 1 1/8" | 33x120x3<br>13" x 47 1/4" x 1 1/8"  |
|--------------|-----------|----------|----------------------------|------------------------------------|------------------------------------|------------------------------------|-------------------------------------|
|              |           |          | battiscopa                 | gradino<br>pz/box 2                | angolo gradino dx<br>pz/box 2      | angolo gradino sx<br>pz/box 2      | angolo gradino<br>dx/sx<br>pz/box 1 |
| RAWTECH      | RAW-WHITE | NATURALE | 752216                     | 753908                             | 753912                             | 753916                             | 754092                              |
|              | RAW-MUD   | NATURALE | 752218                     | 753909                             | 753913                             | 753917                             | 754093                              |
|              | RAW-DUST  | NATURALE | 752219                     | 753910                             | 753914                             | 753918                             | 754094                              |
|              | RAW-COAL  | NATURALE | 752217                     | 753911                             | 753915                             | 753919                             | 754095                              |



FORM OVERSIZE  
**magnum**

**120x240/120x120/60x120**  
Specifica Imballo pag.  
Packaging specifications on page  
Spécifications d'emballage à page  
Verpackungsdetail Seite  
Especificaciones de embalaje a la página  
**162/163**

| RAWTECH | scatola - box |      |       | pallet |       |      |
|---------|---------------|------|-------|--------|-------|------|
|         | pz            | mq   | kg    | box    | mq    | kg   |
| 60x120  | 2             | 1,44 | 28,44 | 30     | 43,20 | 880  |
| 80x80   | 2             | 1,28 | 25,28 | 40     | 51,20 | 1040 |
| 60x60   | 3             | 1,08 | 21,33 | 40     | 43,20 | 880  |
| 30x60   | 6             | 1,08 | 21,33 | 40     | 43,20 | 880  |

**Per un effetto ottimale della posa, Florim suggerisce di mantenere 2 mm di fuga per pose monoformato e 3 mm per combinare formati misti** - For optimal installation results, Florim recommends maintaining a joint of 2 mm 1/12" for single format installations and 3 mm 1/8" to combine mixed formats. - Pour réaliser une pose parfait, Florim conseille de laisser 2 mm de joint pour la pose des monoformats et 3 mm pour les combinaisons de formats mixtes. - Um einen optimalen effekt beim verlegen zu erzielen empfiehlt Florim eine 2 mm fugе bei einformatigen verlegungen und 3 mm fugе bei formatkombinationen Para lograr los máximos resultados en la posa del producto, Florim aconseja 2 mm de junta en aplicaciones monoformato y 3 mm en combinaciones de formatos mixtos.

| RAWTECH           | scatola - box |      |      | pallet |    |    |
|-------------------|---------------|------|------|--------|----|----|
|                   | pz            | ml   | kg   | box    | mq | kg |
| 4,6x60 battiscopa | 14            | 8,40 | 8,40 | -      | -  | -  |

**In relazione alle differenti tecnologie produttive l'accostamento di prodotti con spessori diversi potrebbe presentare delle disomogeneità, se ne sconsiglia pertanto l'abbinamento.** / Due to the different production technologies, contiguous installation of products with different thickness may give a non-homogeneous result. For this reason we do not recommend this option. / Vu que différentes technologies de production sont utilisées avec des épaisseurs différentes, des problèmes d'homogénéité pourraient se présenter, il est donc déconseillé de les poser ensemble. / Wegen unterschiedlicher Produktionstechnologien können die Fliesen mit verschiedenen Materialstärken optische Differenzen aufweisen. Von einem direkten Aneinanderlegen wird deshalb abgeraten. / Dadas las diferentes tecnologías productivas, la combinación de productos de diferentes espesores podría dar lugar a heterogeneidad, por lo que se desaconseja mezclarlas.





# RAWTECH OUTDOOR / PREMIUM

## Vantaggi tecnici - Technical advantages - Avantages techniques Technische Vorteile - Ventajas técnicas

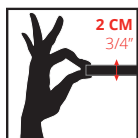

- Lastra monolitica compatta di spessore 2 cm squadrata e rettificata
- Compact monolithic slab 2 cm thick squared and rectified
- Dalle monolithique compacte de 2 cm d'épaisseur, équarrie et rectifiée
- Kompakte monolithische Platte, 2 cm dick, rechteckig und scharfkantig geschliffen
- Losa monolítica compacta de 2 cm de espesor, escuadrada y rectificada.



- INGELIVO
- FROST RESISTANT
- INGÉLIF
- FROSTBESTÄNDIG
- RESISTENTE A LA HELADA



- ELEVATA RESISTENZA AI CARICHI STATICI
- HIGH STATIC LOAD RESISTANCE
- RÉSISTANCE ÉLEVÉE AUX CHARGES STATIQUES
- HOHE STATISCHE BELASTBARKEIT
- ELEVADA RESISTENCIA A LAS CARGAS ESTÁTICAS



- FACILE DA POSARE
- EASY TO INSTALL
- FACILE À POSER
- VERLEGELEICHT
- FÁCIL DE COLOCAR



- ANTISCIVOLO R11
- ANTI SLIP R11
- ANTIDÉRAPANT R11
- RUTSCHFEST R11
- ANTIDESLIZANTE R11

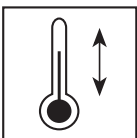

- RESISTENTE AGLI SBALZI TERMICI
- THERMAL SHOCK RESISTANT
- RÉSISTANT AUX ÉCARTS THERMIQUES
- TEMPERATURWECHSELBESTÄNDIG
- RESISTENTE A LAS OSCILACIONES TÉRMICAS



- FACILE DA PULIRE
- EASY TO CLEAN
- FACILE À NETTOYER
- REINIGUNGSLEICHT
- FÁCIL DE LIMPIAR

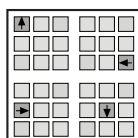

- RIMOVIBILE E RIUTILIZZABILE
- REMOVABLE AND REUSABLE
- DÉMONTABLE ET RÉUTILISABLE
- ENTFERNBAR UND WIEDERVERWENDBAR
- DESMONTABLE Y REUTILIZABLE



- INATTACCABILE DA AGENTI CHIMICI E MUFFE
- IMPERVIOUS TO ATTACK BY CHEMICALS OR MOULD
- RÉSISTANT AUX AGENTS CHIMIQUES ET AUX MOISSISSURES
- UNANGREIFBAR DURCH CHEMISCHE STOFFE UND SCHIMMEL
- RESISTENTE A LOS AGENTES QUÍMICOS Y A LOS MOHOS

## Applicazioni - Applications - Applications - Verlegung - Aplicaciones

- Posa diretta su erba
- Direct installation on grass
- Pose directe sur de l'herbe
- Verlegung direkt auf Rasen
- Colocación directa sobre hierba



- Posa diretta su ghiaia
- Direct installation over gravel
- Pose direct sur du gravier
- Verlegung direkt auf Kies
- Colocación directa sobre grava



- Posa su massetto cementizio
- Installation on sand-cement screed
- Pose sur chape ciment
- Verlegung auf Zement-Unterbetonblock
- Colocación sobre contrapiso de hormigón

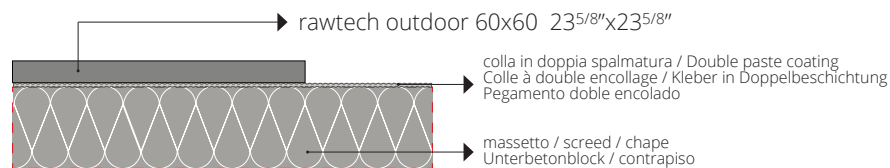

- Posa su piedini fissi o regolabili
- Installation on fixed or adjustable feet
- Pose sur pieds fixes ou réglables
- Verlegung auf feststehende oder regulierbare Füße
- Colocación sobre pies fijos o regulables

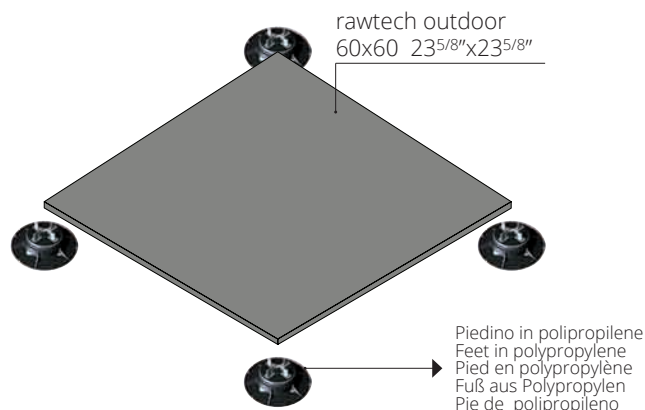

Per le specifiche di utilizzo dei sistemi sopraelevati vedi il sito florim.com  
For the specifics on use of raised systems visit the site florim.com  
Pour les caractéristiques d'utilisation des systèmes surélevés, voir le site florim.com  
Für die Nutzungsbedingungen der Doppelbodensysteme siehe Webseite florim.com  
Para las especificaciones de empleo de los sistemas sobreelevados consulte el sitio web florim.com

Le lastre ceramiche sono sottoposte a un trattamento di compattazione termica che assicura resistenza e durata nel tempo. Il bassissimo assorbimento d'acqua rende perciò il materiale ingelivo. Ciò può comportare ristagni d'acqua superficiali anche per materiale installato a regola d'arte. / Ceramic tiles undergo a compacting thermal treatment that ensures resistance and durability. The low level of water absorption makes the slabs frost resistant. This could result in superficial water stagnations even if materials are installed in a workmanlike manner. / Les carreaux de céramique subissent un traitement thermique de compactage qui assure résistance et durabilité. Le faible niveau d'absorption d'eau rend les dalles résistantes au gel. Il pourrait en résulter des stagnations d'eau superficielles, même si les dalles ont été installées dans les règles de l'art. / Die Keramikplatten werden einer thermischen Verdichtung unterzogen, welche die Widerstandsfähigkeit und Langlebigkeit sichert. Die extrem niedrige Wasseraufnahme macht das Material frostsicher. Die hohe Materialdichte kann, auch bei einer perfekten Verlegung, eine längere Abtrochnungszeit von angestaumtem Wasser zur Folge haben. / Las baldosas cerámicas se someten a un tratamiento de compactación térmica que asegura resistencia y durabilidad. La baja absorción de agua hace que las baldosas resistan al hielo. Esto podría resultar en estancamientos superficiales de agua, incluso si los materiales están instalados según las reglas del arte.



## RAW-WHITE



## RAW-MUD



**R11**  
**CLASSE C**

DCOF >  
0,42 Wet

**20 mm** 3/4" ↑↓

## RAW-DUST



## RAW-COAL



### GRES FINE PORCELLANATO

FINE PORCELAIN STONEWARE/GRES CERAME FIN/FEINSTEINZEUG-KOLLEKTIONEN/GRES PORCELANICO FINO  
SQUADRATO - SQUARED - EQUARRI - REKTIFIZIERT - ESCUADRADO

**20 mm** 3/4" ↑↓

|                | COLOR     | SURFACE     | 60x120<br>23 <sup>5</sup> / <sub>8</sub> "x47 <sup>1</sup> / <sub>4</sub> " | 60x60<br>23 <sup>5</sup> / <sub>8</sub> "x23 <sup>5</sup> / <sub>8</sub> " |
|----------------|-----------|-------------|---|--|
|                | RAW-WHITE | STRUTTURATO | 762773  | 762732   |
|                | RAW-MUD   | STRUTTURATO | -   | 762734   |
| <b>RAWTECH</b> | RAW-DUST  | STRUTTURATO | 762774  | 762735   |
|                | RAW-COAL  | STRUTTURATO | -   | 762733   |

Product Certification  
**BUREAU VERITAS**  
Certification



Recycled material content certification

### PEZZI SPECIALI

Special trims/Pièces spéciales/Formstücke  
Piezas especiales  
**pag 152/155**

| ISO 10545-4   | RESISTENZA ALLA FLESSIONE IN N/mm <sup>2</sup><br>N/mm <sup>2</sup> FLEXURAL STRENGTH TEST / RESISTANCE<br>A LA FLEXION EN N/mm <sup>2</sup> / BIEGEFESTIGKEIT IN<br>N/mm <sup>2</sup> / RESISTENCIA A LA FLEXION EN N/mm <sup>2</sup> | valore medio<br>52 N/mm <sup>2</sup> |
|---|--|--------------------------------------|
|  | <b>Forza di rottura in N (sp. &gt; 7,5 mm)</b><br>Breaking strength in N (thickness > 7,5 mm) / Forza de<br>ruptura en N (esp. > 7,5 mm) / Bruchlast in N (Dicke ><br>7,5 mm) / Fuerza de rotura en N (gr. > 7,5 mm)                   | <b>valore medio<br/>14000 N</b>      |

| RAWTECH            | scatola - box |      |       | pallet |       |     |
|--------------------|---------------|------|-------|--------|-------|-----|
|                    | pz            | mq   | kg    | box    | mq    | kg  |
| 60x120 <b>20mm</b> | 1             | 0,72 | 32,04 | 30     | 21,60 | 990 |
| 60x60 <b>20mm</b>  | 2             | 0,72 | 32,15 | 30     | 21,60 | 990 |



# STONTECH/4.0

gres fine porcellanato  
fine porcelain stoneware  
grès cérame fin  
feinsteinzeug-kollektionen  
gres porcelánico fino







## STONTECH/4.0 / PREMIUM

Progettare è un processo permanente di riflessione in cui seguire un percorso logico pur lasciando spazio alle emozioni, per questo Florim ha deciso di riprogettare la serie **Stontech** che da tempo accompagna il suo modo di interpretare l'abitare. Nuove superfici, nuovi formati e 3 differenti finiture compongono un racconto contemporaneo attento al dettaglio secondo la filosofia del marchio. Due marmi in finitura high-glossy regalano alla serie frammenti di luce preziosa e i grandi formati della famiglia Magnum oversize, in quattro colori, permettono di comporre soluzioni volumetriche inusuali dal forte valore architeturale.

Designing projects is an ongoing process of reflection in which a logical path is followed, while leaving room for the emotions. That's why Florim has decided to redesign the **Stontech** range, which has long been a part of its way of interpreting living spaces. New surfaces, new sizes and 3 different finishes tell a contemporary tale with careful attention paid to the detail, in accordance with the brand philosophy. Two high-gloss finish marbles give the range rays of precious light and the large sizes belonging to the Magnum Oversize family, in four colours, enable solutions to be created with unusual volumes and a considerable architectural content.

Concevoir est un processus de réflexion permanent vers un parcours logique qui laisse libre cours aux émotions, raison pour laquelle Florim a décidé de revisiter la série **Stontech** qui accompagne depuis longtemps sa façon d'interpréter le concept d'habitat. De nouvelles surfaces, de nouveaux formats et trois finitions différentes qui composent un récit moderne et attentif aux détails comme le veut la philosophie de la marque. Deux marbres à la finition ultra brillante embellissent la série de fragments de lumière raffinée tandis que les grands formats de la famille Magnum oversize, disponibles en quatre coloris, permettent de composer des solutions volumétriques inusuelles à forte valeur architecturale.

Die Planungsphase ist ein permanenter Reflexionsprozess, bei dem man einen logischen Weg geht und gleichzeitig dazu Raum für Emotionen lässt. Deshalb hat Florim beschlossen, die Serie **Stontech** neu zu gestalten, die seit geraumer Zeit ihre Interpretationslösungen für den Wohnbereich begleitet. Neue Oberflächen, neue Formate und 3 verschiedene Finishes bilden eine zeitgemäße Kollektion, bei der ganz nach der Philosophie der Marke die Liebe zum Detail im Vordergrund steht. Zwei hochglänzende Marmorsteine verleihen der Serie wertvolle Lichtfragmente. Die vier Farben der Großformate der Produktfamilie Magnum Oversize schaffen ungewöhnliche volumetrische Lösungen von hohem architektonischem Wert.

Diseñar es un proceso permanente de reflexión en el que hay que seguir una trayectoria lógica dejando espacio a las emociones y, precisamente por eso, Florim ha decidido volver a diseñar la serie **Stontech** que desde hace tiempo acompaña su forma de interpretar la vivienda. Nuevas superficies, nuevos formatos y 3 acabados distintos componen una historia contemporánea atenta al detalle según la filosofía de la marca. Dos mármoles con un acabado high-glossy aportan a la serie fragmentos de una luz preciosa y los grandes formatos de la familia Magnum oversize, en cuatro colores, permiten componer soluciones volumétricas inusuales con un fuerte valor arquitectónico.

# STONTECH/4.0 / PREMIUM

## STONE\_01



## STONE\_02



**GRES FINE PORCELLANATO**  
FINE PORCELAIN STONEWARE / GRÈS CÉRAME FIN / FEINSTEINZEUG-KOLLEKTIONEN / GRES PORCELÁNICO FINO  
SQUADRATO - SQUARED - EQUARRI - REKTIFIZIERT - ESCUADRADO

| 9 mm 3/8" ↑↓ |  | COLOR       | SURFACE | 60x120<br>23 <sup>5/8"</sup> x47 <sup>1/4"</sup> | 80x80<br>31 <sup>1/2"</sup> x31 <sup>1/2"</sup> | 60x60<br>23 <sup>5/8"</sup> x23 <sup>5/8"</sup> | 30x60<br>11 <sup>4/5"</sup> x23 <sup>5/8"</sup> |
|--------------|--|-------------|---------|--|---|---|---|
| STONE_01     |  | NATURALE    |         | 761172   | 761184  | 761166  | 761160  |
|              |  | HIGH-GLOSSY |         | 761206   | 761210  | 761204  | 761202  |
|              |  | STRUTTURATO |         | 761212   | -   | -   | -   |
|              |  | CANNETÈ     |         | 761218   | -   | -   | -   |
|              |  | R+PTV       |         | 761190   | -   | 761196  | 761263  |
| STONE_02     |  | NATURALE    |         | 761173   | 761185  | 761167  | 761161  |
|              |  | STRUTTURATO |         | 761213   | -   | -   | -   |
|              |  | CANNETÈ     |         | 761219   | -   | -   | -   |
|              |  | R+PTV       |         | 761191   | -   | 761197  | 761264  |

| 6 mm 1/4" ↑↓ |  | COLOR       | SURFACE | 120x240<br>47 <sup>1/4"</sup> x94 <sup>1/2"</sup> | 120x120<br>47 <sup>1/4"</sup> x47 <sup>1/4"</sup> | 60x120<br>23 <sup>5/8"</sup> x47 <sup>1/4"</sup> |
|--------------|--|-------------|---------|---|---|--|
| STONE_01     |  | NATURALE    |         | 761508  | 761514  | 761520   |
|              |  | HIGH-GLOSSY |         | 761506  | 761512  | 761518   |
| STONE_02     |  | NATURALE    |         | 761509  | 761515  | 761521   |
|              |  | R+PTV       |         | 762817  | 762813  | -  |



**R9**  
(naturale/  
cannetè)

**R10**  
**Classe B**  
(R+PTV)

**R11**  
**Classe C**  
(strutturato)

DCOF>  
0,42 Wet  
(naturale/  
R+PTV/  
strutturato/  
cannetè)

BS EN 16165  
ANNEX C  
>36 wet  
slider 96  
R+PTV

9 mm 3/8" ↑↓



**R9**  
(naturale)

**R10**  
**Classe B**  
(R+PTV)

DCOF>  
0,42 Wet

BS EN 16165  
ANNEX C  
>36 wet  
slider 96  
R+PTV

6 mm 1/4" ↑↓

FLOFORM OVERSIZE  
**magnum**

## STONE\_03

## STONE\_04



**V2**

**R9**  
(naturale/  
cannetè)

**R10**  
**Classe B**  
(R+PTV)

**R11**  
**Classe C**  
(strutturato)

DCOF>  
0,42 Wet  
(naturale/  
R+PTV/  
strutturato/  
cannetè)



BS EN 16165  
ANNEX C  
>36 wet  
slider 96  
R+PTV

**9 mm** 3/8" ↑↓

### GRES FINE PORCELLANATO

FINE PORCELAIN STONEWARE / GRÈS CÉRAMÉ FIN / FEINSTEINZEUG-KOLLEKTIONEN / GRES PORCELÁNICO FINO  
SQUADRATO - SQUARED - EQUARRI - REKTIFIZIERT - ESCUADRADO

**9 mm** 3/8" ↑↓

|                 | COLOR   | SURFACE     | <b>60x120</b><br>23 <sup>5/8</sup> "x47 <sup>1/4</sup> " | <b>80x80</b><br>31 <sup>1/2</sup> "x31 <sup>1/2</sup> " | <b>60x60</b><br>23 <sup>5/8</sup> "x23 <sup>5/8</sup> " | <b>30x60</b><br>11 <sup>4/5</sup> "x23 <sup>5/8</sup> " |
|-----------------|---|-------------|--|---|---|---|
| <b>STONE_03</b> |  | NATURALE    | 761174   | 761186  | 761168  | 761162  |
|                 |   | STRUTTURATO | 761214   | -   | -   | -   |
|                 |   | CANNETÈ     | 761220   | -   | -   | -   |
|                 |   | R+PTV       | 761192   | -   | 761198  | 761265  |
| <b>STONE_04</b> |  | NATURALE    | 761175   | 761187  | 761169  | 761163  |
|                 |   | STRUTTURATO | 761215   | -   | -   | -   |
|                 |   | CANNETÈ     | 761221   | -   | -   | -   |
|                 |   | R+PTV       | 761193   | -   | 761199  | 761266  |

### STONTECH/4.0

# STONTECH/4.0 / PREMIUM

| 9 mm 3/8" ↑  | COLOR    | SURFACE     | 30x30<br>11 4/5" x 11 4/5"       | 21x40<br>8 1/4" x 15 3/4" |
|--------------|----------|-------------|----------------------------------|---------------------------|
|              |          |             | mosaico tessere 3x3<br>pz/box 11 | modulo listello sfalsato  |
| STONTECH/4.0 |          | NATURALE    | 761487                           | 761477                    |
|              |          | HIGH-GLOSSY | 761484                           | 761475                    |
|              | STONE_02 | NATURALE    | 761488                           | 761478                    |
|              | STONE_03 | NATURALE    | 761489                           | 761480                    |
|              | STONE_04 | NATURALE    | 761491                           | 761481                    |

## PEZZI SPECIALI/SPECIAL TRIMS/PIÈCES SPÉCIALES/FORMSTÜCKE/PIEZAS ESPECIALES

| 9 mm 3/8" ↑  | COLOR    | SURFACE     | 4,6x60<br>1 4/5" x 23 5/8" | 33x120x3<br>13" x 47 1/4" x 1 1/8" | 33x120x3<br>13" x 47 1/4" x 1 1/8" | 33x120x3<br>13" x 47 1/4" x 1 1/8" |
|--------------|----------|-------------|----------------------------|------------------------------------|------------------------------------|------------------------------------|
|              |          |             | battiscopa                 | gradino<br>pz/box 2                | angolo gradino dx<br>pz/box 2      | angolo gradino sx<br>pz/box 2      |
| STONTECH/4.0 |          | NATURALE    | 761451                     | 761457                             | 761463                             | 761469                             |
|              |          | HIGH-GLOSSY | 761449                     | -                                  | -                                  | -                                  |
|              | STONE_02 | NATURALE    | 761452                     | 761458                             | 761464                             | 761470                             |
|              | STONE_03 | NATURALE    | 761453                     | 761459                             | 761465                             | 761471                             |
|              | STONE_04 | NATURALE    | 761454                     | 761460                             | 761466                             | 761472                             |



FLORIM OVERSIZE  
magnum

**160x320/120x240/120x120/60x120**  
 Specifica Imballo pag.  
 Packaging specifications on page  
 Spécifications d'emballage à page  
 Verpackungsdetail Seite  
 Especificaciones de embalaje a la página  
**152/155**

| STONTECH/4.0                   | scatola - box |      |       | pallet |       |      |
|--------------------------------|---------------|------|-------|--------|-------|------|
|                                | pz            | mq   | kg    | box    | mq    | kg   |
| 60x120                         | 2             | 1,44 | 28,44 | 30     | 43,20 | 880  |
| 80x80                          | 2             | 1,28 | 25,28 | 40     | 51,20 | 1040 |
| 60x60                          | 3             | 1,08 | 21,33 | 40     | 43,20 | 880  |
| 30x60                          | 6             | 1,08 | 21,33 | 40     | 43,20 | 880  |
| 21x40 modulo listello sfalsato | 5             | 0,42 | 9,66  | 40     | 16,80 | 420  |







**Per un effetto ottimale della posa, Florim suggerisce di mantenere 2 mm di fuga per pose monoformato e 3 mm per combinare formati misti** - For optimal installation results, Florim recommends maintaining a joint of 2 mm 1/12" for single format installations and 3 mm 1/8" to combine mixed formats. - Pour réaliser une pose parfaite, Florim conseille de laisser 2 mm de joint pour la pose des monoformats et 3 mm pour les combinaisons de formats mixtes. - Um einen optimalen Effekt beim Verlegen zu erzielen empfiehlt Florim eine 2 mm fugen bei einformatigen Verlegungen und 3 mm fugen bei formatkombinationen. Para lograr los máximos resultados en la posa del producto, Florim aconseja 2 mm de junta en aplicaciones monoformato y 3 mm en combinaciones de formatos mixtos.

| STONTECH/4.0      | scatola - box |      |      | pallet |    |    |
|-------------------|---------------|------|------|--------|----|----|
|                   | pz            | ml   | kg   | box    | mq | kg |
| 4,6x60 battiscopa | 14            | 8,40 | 8,40 | -      | -  | -  |

**In relazione alle differenti tecnologie produttive l'accostamento di prodotti con spessori diversi potrebbe presentare delle disomogeneità, se ne sconsiglia pertanto l'abbinamento.** / Due to the different production technologies, contiguous installation of products with different thickness may give a non-homogeneous result. For this reason we do not recommend this option. / Vu que différentes technologies de production sont utilisées avec des épaisseurs différentes, des problèmes d'homogénéité pourraient se présenter, il est donc déconseillé de les poser ensemble. / Wegen unterschiedlicher Produktionstechnologien können die Fliesen mit verschiedenen Materialstärken optische Differenzen aufweisen. Von einem direkten Aneinanderlegen wird deshalb abgeraten. / Dadas las diferentes tecnologías productivas, la combinación de productos de diferentes espesores podría dar lugar a heterogeneidad, por lo que se desaconseja mezclarlas.



PEZZI SPECIALI/SPECIAL TRIMS/PIÈCES SPÉCIALES/FORMSTÜCKE/PIEZAS ESPECIALES

| 6 mm 1/4"  |   |          |             | 30x30<br>11 4/5"x11 4/5"<br><br>mosaico<br>tessere 7,5x7,5<br>pz/box 11 | 30x30<br>11 4/5"x11 4/5"<br><br>muretto<br>tessere 7,5x15<br>pz/box 11 | 30x30<br>11 4/5"x11 4/5"<br><br>mosaico<br>tessere 1,5x3<br>pz/box 11 | 4,6x80<br>1 4/5"x31 1/2"<br><br>battiscopa |
|---|---|----------|-------------|--|--|--|---|
| STONTECH/4.0  |  | STONE_01 | NATURALE    | 761439   | 761445   | 761433   | 761427  |
|   |   |          | HIGH-GLOSSY | 761437   | 761443   | 761431   | 761425  |
|   |  | STONE_02 | NATURALE    | 761440   | 761446   | 761434   | 761428  |

## STONE\_01

4 grafiche continue / 4 continuous pattern graphics

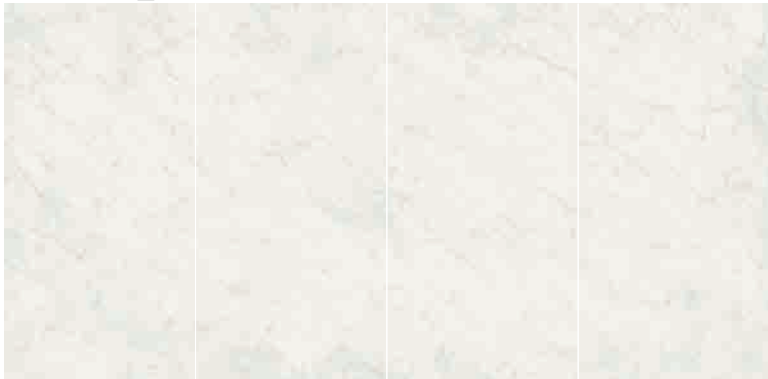

### Es. posa:

Il disegno riprodotto è indicativo. Come per il materiale naturale la grafica può mostrare discontinuità di vena nel passaggio da una lastra all'altra. Per questo motivo differenze fino a 1,5 cm devono essere considerate come caratteristica del prodotto; non è garantita la sequenza delle facce in fase di approntamento dell'ordine.

### Example of installation:

The drawing is indicative. As with natural material, graphics may show vein discontinuities in the transition from one slab to another. For this reason, differences of up to 1.5 cm must be considered as a product characteristic. The sequence of the faces is not guaranteed when placing the order.

| 6 mm 1/4"  |   | COLOR    | SURFACE | 160x320<br>63"x126" |
|---|---|----------|---------|---------------------|
| STONTECH/4.0  |  | STONE_01 | MATTE   | 777637              |

Le grafiche sopra riportate si riferiscono al formato 160x320 / The above designs refer to size 160x320 cm / Les graphismes indiqués ci-dessus se réfèrent au format 160x320  
Die oben abgebildeten Grafiken beziehen sich auf das Format 160x320 / Las gráficas arriba indicadas se refieren a la medida 160x320.

# STONTECH/4.0 OUTDOOR / PREMIUM

## Vantaggi tecnici - Technical advantages - Avantages techniques Technische Vorteile - Ventajas técnicas

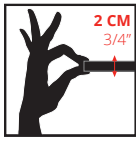

- Lastra monolitica compatta di spessore 2 cm squadrata e rettificata
- Compact monolithic slab 2 cm thick squared and rectified
- Dalle monolithique compacte de 2 cm d'épaisseur, équarrie et rectifiée
- Kompakte monolithische Platte, 2 cm dick, rechteckig und scharfkantig geschliffen
- Losa monolítica compacta de 2 cm de espesor, escuadrada y rectificada.



- INGELIVO
- FROST RESISTANT
- INGÉLIF
- FROSTBESTÄNDIG
- RESISTENTE A LA HELADA



- ELEVATA RESISTENZA AI CARICHI STATICI
- HIGH STATIC LOAD RESISTANCE
- RÉSISTANCE ÉLEVÉE AUX CHARGES STATIQUES
- HOHE STATISCHE BELASTBARKEIT
- ELEVADA RESISTENCIA A LAS CARGAS ESTÁTICAS

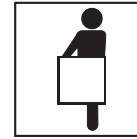

- FACILE DA POSARE
- EASY TO INSTALL
- FACILE À POSER
- VERLEGELEICHT
- FÁCIL DE COLOCAR



- ANTISCIVOLO R11
- ANTI SLIP R11
- ANTIDÉRAPANT R11
- RUTSCHFEST R11
- ANTIDESLIZANTE R11

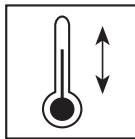

- RESISTENTE AGLI SBALZI TERMICI
- THERMAL SHOCK RESISTANT
- RÉSISTANT AUX ÉCARTS THERMIQUES
- TEMPERATURWECHSELBESTÄNDIG
- RESISTENTE A LAS OSCILACIONES TÉRMICAS



- FACILE DA PULIRE
- EASY TO CLEAN
- FACILE À NETTOYER
- REINIGUNGSLEICHT
- FÁCIL DE LIMPIAR

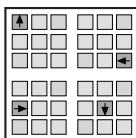

- RIMOVIBILE E RIUTILIZZABILE
- REMOVABLE AND REUSABLE
- DÉMONTABLE ET RÉUTILISABLE
- ENTFERNBAR UND WIEDERVERWENDBAR
- DESMONTABLE Y REUTILIZABLE



- INATTACCABILE DA AGENTI CHIMICI E MUFFE
- IMPERVIOUS TO ATTACK BY CHEMICALS OR MOULD
- RÉSISTANT AUX AGENTS CHIMIQUES ET AUX MOISSISSURES
- UNANGREIFBAR DURCH CHEMISCHE STOFFE UND SCHIMMEL
- RESISTENTE A LOS AGENTES QUÍMICOS Y A LOS MOHOS

## Applicazioni - Applications - Applications - Verlegung - Aplicaciones

- Posa diretta su erba
- Direct installation on grass
- Pose directe sur de l'herbe
- Verlegung direkt auf Rasen
- Colocación directa sobre hierba



- Posa diretta su ghiaia
- Direct installation over gravel
- Pose direct sur du gravier
- Verlegung direkt auf Kies
- Colocación directa sobre grava



- Posa su massetto cementizio
- Installation on sand-cement screed
- Pose sur chape ciment
- Verlegung auf Zement-Unterbetonblock
- Colocación sobre contrapiso de hormigón

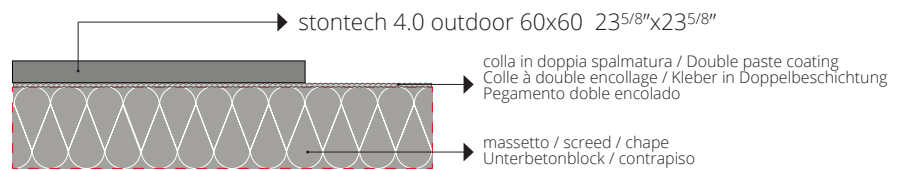

- Posa su piedini fissi o regolabili
- Installation on fixed or adjustable feet
- Pose sur pieds fixes ou réglables
- Verlegung auf feststehende oder regulierbare Füße
- Colocación sobre pies fijos o regulables

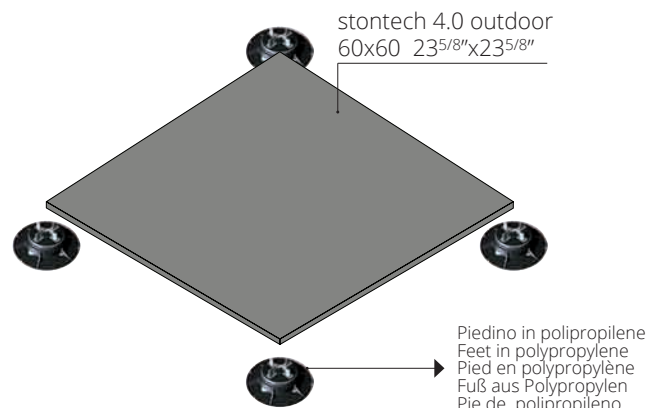

Per le specifiche di utilizzo dei sistemi sopraelevati vedi il sito florim.com  
For the specifics on use of raised systems visit the site florim.com  
Pour les caractéristiques d'utilisation des systèmes surélevés, voir le site florim.com  
Für die Nutzungsbedingungen der Doppelbodensysteme siehe Webseite florim.com  
Para las especificaciones de empleo de los sistemas sobreelevados consulte el sitio web florim.com

Le lastre ceramiche sono sottoposte a un trattamento di compattazione termica che assicura resistenza e durata nel tempo. Il bassissimo assorbimento d'acqua rende perciò il materiale ingelivo. Ciò può comportare ristagni d'acqua superficiali anche per materiale installato a regola d'arte. / Ceramic tiles undergo a compacting thermal treatment that ensures resistance and durability. The low level of water absorption makes the slabs frost resistant. This could result in superficial water stagnations even if materials are installed in a workmanlike manner. / Les carreaux de céramique subissent un traitement thermique de compactage qui assure résistance et durabilité. Le faible niveau d'absorption d'eau rend les dalles résistantes au gel. Il pourrait en résulter des stagnations d'eau superficielles, même si les dalles ont été installées dans les règles de l'art. / Die Keramikplatten werden einer thermischen Verdichtung unterzogen, welche die Widerstandsfähigkeit und Langlebigkeit sichert. Die extrem niedrige Wasseraufnahme macht das Material frostsicher. Die hohe Materialdichte kann, auch bei einer perfekten Verlegung, eine längere Abtrocknungszeit von angestaumtem Wasser zur Folge haben. / Las baldosas cerámicas se someten a un tratamiento de compactación térmica que asegura resistencia y durabilidad. La baja absorción de agua hace que las baldosas resistan al hielo. Esto podría resultar en estancamientos superficiales de agua, incluso si los materiales están instalados según las reglas del arte.

## STONE\_01



## STONE\_02



**R11  
CLASSE C**

DCOF >  
0,42 Wet

**20 mm 3/4"** ↑ ↓

## STONE\_03



## STONE\_04

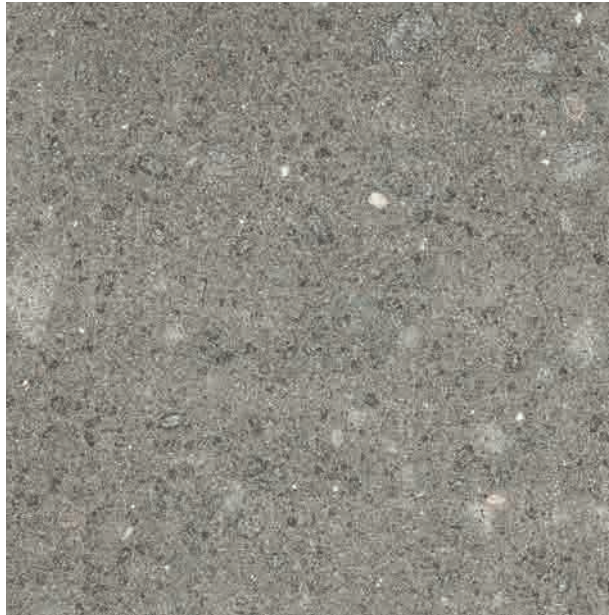

### GRES FINE PORCELLANATO

FINE PORCELAIN STONEWARE/GRES CERAME FIN/FEINSTEINZEUG-KOLLEKTIONEN/GRES PORCELANICO FINO  
SQUADRATO - SQUARED - EQUARRI - REKTIFIZIERT - ESCUADRADO

**20 mm 3/4"** ↑ ↓

| COLOR | SURFACE | 60x120<br>23 <sup>5/8"</sup> x47 <sup>1/4"</sup> |
|-------|---------|--|
|-------|---------|--|

|   |          |             |        |
|---|----------|-------------|--------|
|  | STONE_01 | STRUTTURATO | 762788 |
|---|----------|-------------|--------|

|   |          |             |        |
|---|----------|-------------|--------|
|  | STONE_02 | STRUTTURATO | 762789 |
|---|----------|-------------|--------|

### STONTECH/4.0

|   |          |             |        |
|---|----------|-------------|--------|
|  | STONE_03 | STRUTTURATO | 762790 |
|---|----------|-------------|--------|

|   |          |             |        |
|---|----------|-------------|--------|
|  | STONE_04 | STRUTTURATO | 762791 |
|---|----------|-------------|--------|

### PEZZI SPECIALI

Special trims/Pièces spéciales/Formstücke  
Piezas especiales  
pag 162/163



Recycled material content certification

**20mm  
STONE\_03 / STONE\_04**

| ISO 10545-4   | RESISTENZA ALLA FLESSIONE IN N/mm <sup>2</sup><br>N/mm <sup>2</sup> FLEXURAL STRENGTH TEST / RESISTANCE<br>A LA FLEXION EN N/mm <sup>2</sup> / BIEGEFESTIGKEIT IN<br>N/mm <sup>2</sup> / RESISTENCIA A LA FLEXION EN N/mm <sup>2</sup> | valore medio<br>52 N/mm <sup>2</sup> |
|---|--|--------------------------------------|
|  | Forza di rottura in N (sp. > 7,5 mm)<br>Breaking strength in N (thickess > 7,5 mm) / Force de<br>rupture en N (ép. > 7,5 mm) / Bruchlast in N (Dicke ><br>7,5 mm) / Fuerza de rotura en N (es. > 7,5 mm)                               | valore medio<br>14000 N              |

| STONTECH/4.0 | scatola - box |      |       | pallet |       |      |
|--------------|---------------|------|-------|--------|-------|------|
|              | pz            | mq   | kg    | box    | mq    | kg   |
| 60x120 20mm  | 1             | 0,72 | 32,26 | 30     | 21,60 | 1000 |







## WALKS/1.0

gres fine porcellanato  
fine porcelain stoneware  
grès cérame fin  
feinsteinzeug-kollektionen  
gres porcelánico fino





## WALKS/1.0 / PREMIUM

**Walks 1.0** è tecnologia e natura, unite in modo esatto e incisivo. Precisione estetica, rigore e pulizia formale contraddistinguono le scelte cromatiche che caratterizzano la serie accentuando la sua semplicità non convenzionale. Disponibile in due finiture, soft e naturale, è perfetta per interpretare architetture di interni e spazi esterni che dialogano con il paesaggio circostante. Un design dal linguaggio internazionale, accattivante e senza tempo.

**Walks 1.0** is technology and nature, precisely and incisively joint. Aesthetical precision, rigour and formal cleaning distinguish the colour choices that characterise the series, accentuating its unconventional simplicity. Available in two finishes, soft and natural, it is perfect for interpreting indoor architecture and outdoor spaces that converse with the surrounding setting. A design with international language, catchy and timeless.

**Walks 1.0** est la technologie et la nature qui s'unissent parfaitement de manière incisive. Précision esthétique, rigueur et netteté formelle distinguent les choix des teintes qui caractérisent la série en accentuant sa simplicité non conventionnelle. Disponible en deux finitions, soft et naturelle, elle s'adapte parfaitement à l'interprétation d'architectures d'intérieurs et d'espaces extérieurs qui dialoguent avec le paysage qui les entoure. Un design avec un langage International, captivant et intemporel.

**Walks 1.0** ist auf exakte und einprägsame Art mit Natur vereinte Technologie. Ästhetische Präzision, Strenge und Reinheit der Formen zeichnen die Farbwahl der Serie aus und betonen deren unkonventionelle Einfachheit. Sie ist in den zwei Endbearbeitungen, Soft und Natürlich, erhältlich und eignet sich perfekt dazu, Innenarchitekturen und Außenflächen in Harmonie mit der umliegenden Landschaft zu interpretieren. Ein Design mit internationalem, ansprechendem und zeitlosen Flair.

**Walks 1.0** es tecnología y naturaleza, unidas en un modo exacto e incisivo. Precisión estética, rigor y limpieza formal contradistinguen las elecciones cromáticas que caracterizan la serie, acentuando su sencillez no convencional. Disponible en dos acabados, soft y natural, es perfecta para interpretar arquitecturas de interiores y exteriores, que dialogan con el paisaje alrededor. Un diseño con un lenguaje internacional, cautivador y sin tiempo.



# WALKS/1.0 / PREMIUM

## WHITE



## GRAY

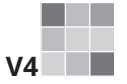

V4

**R11**  
Classe C  
(naturale)

**R9**  
(soft)

DCOF>  
0,42 Wet

9 mm 3/8" ↑↓

### GRES FINE PORCELLANATO

FINE PORCELAIN STONEWARE / GRÈS CÉRAME FIN / FEINSTEINZEUG-KOLLEKTIONEN / GRES PORCELÁNICO FINO  
SQUADRATO - SQUARED - EQUARRI - REKTIFIZIERT - ESCUADRADO

| 9 mm 3/8" ↑↓ | COLOR | SURFACE  | 60x120                                 | 40x80                                  | 60x60                                  | 30x60                                  |
|--------------|-------|----------|--|--|--|--|
|              |       |          | 23 <sup>5/8"</sup> x47 <sup>1/4"</sup> | 15 <sup>3/4"</sup> x31 <sup>1/2"</sup> | 23 <sup>5/8"</sup> x23 <sup>5/8"</sup> | 11 <sup>4/5"</sup> x23 <sup>5/8"</sup> |
| WALKS/1.0    | WHITE | NATURALE | 742827                                 | 728722                                 | 728746                                 | 728755                                 |
|              |       | SOFT     | 742831                                 | 728726                                 | 728750                                 | 728759                                 |
|              | GRAY  | NATURALE | 742828                                 | 728723                                 | 728747                                 | 728756                                 |
|              |       | SOFT     | 742832                                 | 728727                                 | 728752                                 | 728760                                 |



## BEIGE



## BLACK



V4

**R11**  
Classe C  
(naturale)



**R9**  
(soft)

DCOF>  
0,42 Wet







9 mm 3/8" ↑↓

### GRES FINE PORCELLANATO











FINE PORCELAIN STONEWARE / GRÈS CÉRAMÉ FIN / FEINSTEINZEUG-KOLLEKTIONEN / GRES PORCELÁNICO FINO  
SQUADRATO - SQUARED - EQUARRI - REKTIFIZIERT - ESCUADRADO

| 9 mm 3/8" ↑↓     |   | COLOR | SURFACE  | 60x120<br>23 <sup>5/8"</sup> x47 <sup>1/4"</sup> | 40x80<br>15 <sup>3/4"</sup> x31 <sup>1/2"</sup> | 60x60<br>23 <sup>5/8"</sup> x23 <sup>5/8"</sup> | 30x60<br>11 <sup>4/5"</sup> x23 <sup>5/8"</sup> |
|------------------|---|-------|----------|--|---|---|---|
| <b>WALKS/1.0</b> |  | BEIGE | NATURALE | 742829   | 728724  | 728748  | 728757  |
|                  |   |       | SOFT     | 742833   | 728728  | 728753  | 728761  |
|                  |  | BLACK | NATURALE | 742830   | 728725  | 728749  | 728758  |
|                  |   |       | SOFT     | 742834   | 728729  | 728754  | 728762  |

# WALKS/1.0 / PREMIUM

| 9 mm 3/8" ↑↓ |   |          |   | 30x30<br>11 4/5" x 11 4/5"  | 21x40<br>8 1/4" x 15 3/4" |
|--------------|---|----------|---|---|---------------------------|
|              | COLOR   | SURFACE  |  |  |                           |
| WALKS/1.0    |  | NATURALE | 728797  | 728780  |                           |
|              |   | SOFT     | -   | 729495  |                           |
|              |  | NATURALE | 728799  | 728782  |                           |
|              |   | SOFT     | -   | 729498  |                           |
|              |  | NATURALE | 728798  | 728781  |                           |
|              |   | SOFT     | -   | 729496  |                           |
|              |  | NATURALE | 728800  | 728783  |                           |
|              |   | SOFT     | -   | 729500  |                           |

## PEZZI SPECIALI/SPECIAL TRIMS/PIÈCES SPÉCIALES/FORMSTÜCKE/PIEZAS ESPECIALES

| 9 mm 3/8" ↑↓ |   |          |  | 4,6x60<br>1 4/5" x 23 5/8"   | 33x60x3<br>13" x 23 5/8" x 1 1/8"   | 33x33x3<br>13" x 13" x 1 1/8"  | 20x30x6<br>7 7/8" x 11 4/5" x 2 1/8"   | 1x20<br>2 1/5" x 7 7/8"  | 1x21<br>2 1/5" x 8 1/4" |
|--------------|---|----------|--|--|---|--|--|--|-------------------------|
|              | COLOR   | SURFACE  |  |  |  |  |  |  |                         |
| WALKS/1.0    |  | NATURALE | -  | 728784   | 728788  | 728801   | 728831   | 728835   |                         |
|              |   | SOFT     | 745559   | -  | -   | -  | -  |  |                         |
|              |  | NATURALE | -  | 728786   | 728791  | 728805   | 728833   | 728837   |                         |
|              |   | SOFT     | 745561   | -  | -   | -  | -  |  |                         |
|              |  | NATURALE | -  | 728785   | 728790  | 728804   | 728832   | 728836   |                         |
|              |   | SOFT     | 745560   | -  | -   | -  | -  |  |                         |
|              |  | NATURALE | -  | 728787   | 728792  | 728806   | 728834   | 728838   |                         |
|              |   | SOFT     | 745562   | -  | -   | -  | -  |  |                         |

| WALKS/1.0                 | scatola - box |      |       | pallet |       |      |
|---------------------------|---------------|------|-------|--------|-------|------|
|                           | pz            | mq   | kg    | box    | mq    | kg   |
| 60x120                    | 2             | 1,44 | 28,44 | 30     | 43,20 | 880  |
| 40x80                     | 3             | 0,96 | 18,96 | 56     | 53,76 | 1090 |
| 60x60                     | 3             | 1,08 | 21,33 | 40     | 43,20 | 880  |
| 30x60                     | 6             | 1,08 | 21,33 | 40     | 43,20 | 880  |
| 21x40 mod. list. sfalsato | 5             | 0,42 | 8,40  | 40     | 16,80 | 360  |
| 30x30 mosaico             | 11            | 1,00 | 20,00 | 30     | 30,00 | 630  |

| WALKS/1.0         | scatola - box |      |      | pallet |    |    |
|-------------------|---------------|------|------|--------|----|----|
|                   | pz            | ml   | kg   | box    | mq | kg |
| 4,6x60 battiscopa | 14            | 8,40 | 8,40 | -      | -  | -  |

**Per un effetto ottimale della posa, Florim suggerisce di mantenere 2 mm di fuga per pose monoformato e 3 mm per combinare formati misti.** - For optimal installation results, Florim recommends maintaining a joint of 2 mm for single format installations and 3 mm for mixed format combinations. - Pour réaliser une pose parfaite, Florim conseille de laisser 2 mm de joint pour la pose des monoformats et 3 mm pour les combinaisons de formats mixtes. - Um einen optimalen Effekt beim Verlegen zu erzielen empfiehlt Florim eine 2 mm Fuge bei einformatigen Verlegungen und 3 mm Fuge bei Formatkombinationen. Para lograr los máximos resultados en la posa del producto, Florim aconseja 2 mm de junta en aplicaciones monoformato y 3 mm en combinaciones de formatos mixtos.





# WALKS/1.0 OUTDOOR / PREMIUM

## Vantaggi tecnici - Technical advantages - Avantages techniques Technische Vorteile - Ventajas técnicas

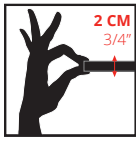

- Lastra monolitica compatta di spessore 2 cm squadrata e rettificata
- Compact monolithic slab 2 cm thick squared and rectified
- Dalle monolithique compacte de 2 cm d'épaisseur, équarrie et rectifiée
- Kompakte monolithische Platte, 2 cm dick, rechteckig und scharfkantig geschliffen
- Losa monolítica compacta de 2 cm de espesor, escuadrada y rectificada.



- INGELIVO
- FROST RESISTANT
- INGÉLIF
- FROSTBESTÄNDIG
- RESISTENTE A LA HELADA



- ELEVATA RESISTENZA AI CARICHI STATICI
- HIGH STATIC LOAD RESISTANCE
- RÉSISTANCE ÉLEVÉE AUX CHARGES STATIQUES
- HOHE STATISCHE BELASTBARKEIT
- ELEVADA RESISTENCIA A LAS CARGAS ESTÁTICAS

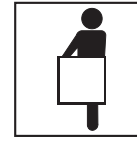

- FACILE DA POSARE
- EASY TO INSTALL
- FACILE À POSER
- VERLEGELEICHT
- FÁCIL DE COLOCAR



- ANTISCIVOLO R11
- ANTI SLIP R11
- ANTIDÉRAPANT R11
- RUTSCHFEST R11
- ANTIDESLIZANTE R11

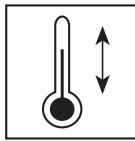

- RESISTENTE AGLI SBALZI TERMICI
- THERMAL SHOCK RESISTANT
- RÉSISTANT AUX ÉCARTS THERMIQUES
- TEMPERATURWECHSELBESTÄNDIG
- RESISTENTE A LAS OSCILACIONES TÉRMICAS



- FACILE DA PULIRE
- EASY TO CLEAN
- FACILE À NETTOYER
- REINIGUNGSEICHT
- FÁCIL DE LIMPIAR

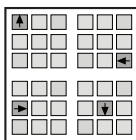

- RIMOVIBILE E RIUTILIZZABILE
- REMOVABLE AND REUSABLE
- DÉMONTABLE ET RÉUTILISABLE
- ENTFERNBAR UND WIEDERVERWENDBAR
- DESMONTABLE Y REUTILIZABLE



- INATTACCABILE DA AGENTI CHIMICI E MUFFE
- IMPERVIOUS TO ATTACK BY CHEMICALS OR MOULD
- RÉSISTANT AUX AGENTS CHIMIQUES ET AUX MOISSISSURES
- UNANGREIFBAR DURCH CHEMISCHE STOFFE UND SCHIMMEL
- RESISTENTE A LOS AGENTES QUÍMICOS Y A LOS MOHOS

## Applicazioni - Applications - Applications - Verlegung - Aplicaciones

- Posa diretta su erba
- Direct installation on grass
- Pose directe sur de l'herbe
- Verlegung direkt auf Rasen
- Colocación directa sobre hierba

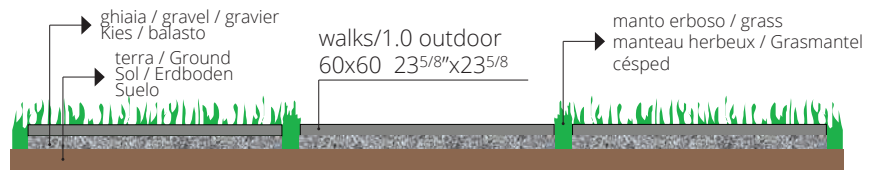

- Posa diretta su ghiaia
- Direct installation over gravel
- Pose direct sur du gravier
- Verlegung direkt auf Kies
- Colocación directa sobre grava



- Posa su massetto cementizio
- Installation on sand-cement screed
- Pose sur chape ciment
- Verlegung auf Zement-Unterbetonblock
- Colocación sobre contrapiso de hormigón

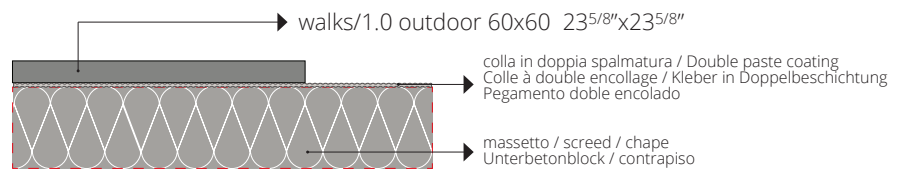

- Posa su piedini fissi o regolabili
- Installation on fixed or adjustable feet
- Pose sur pieds fixes ou réglables
- Verlegung auf feststehende oder regulierbare Füße
- Colocación sobre pies fijos o regulables

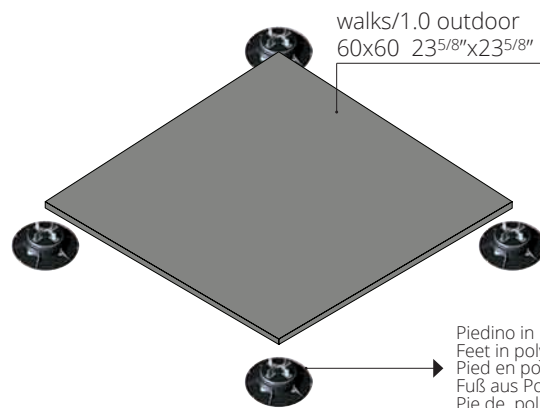

Per le specifiche di utilizzo dei sistemi sopraelevati vedi il sito florim.com  
For the specifics on use of raised systems visit the site florim.com  
Pour les caractéristiques d'utilisation des systèmes surélevés, voir le site florim.com  
Für die Nutzungsbedingungen der Doppelbodensysteme siehe Webseite florim.com  
Para las especificaciones de empleo de los sistemas sobreelevados consulte el sitio web florim.com

Piedino in polipropilene  
Feet in polypropylene  
Pied en polypropylène  
Fuß aus Polypropylen  
Pie de polipropileno

Le lastre ceramiche sono sottoposte a un trattamento di compattazione termica che assicura resistenza e durata nel tempo. Il bassissimo assorbimento d'acqua rende perciò il materiale ingelivo. Ciò può comportare ristagni d'acqua superficiali anche per materiale installato a regola d'arte. / Ceramic tiles undergo a compacting thermal treatment that ensures resistance and durability. The low level of water absorption makes the slabs frost resistant. This could result in superficial water stagnations even if materials are installed in a workmanlike manner. / Les carreaux de céramique subissent un traitement thermique de compactage qui assure résistance et durabilité. Le faible niveau d'absorption d'eau rend les dalles résistantes au gel. Il pourrait en résulter des stagnations d'eau superficielles, même si les dalles ont été installées dans les règles de l'art. / Die Keramikplatten werden einer thermischen Verdichtung unterzogen, welche die Widerstandsfähigkeit und Langlebigkeit sichert. Die extrem niedrige Wasseraufnahme macht das Material frostsicher. Die hohe Materialdichte kann, auch bei einer perfekten Verlegung, eine längere Abtrocknungszeit von angestaumtem Wasser zur Folge haben. / Las baldosas cerámicas se someten a un tratamiento de compactación térmica que asegura resistencia y durabilidad. La baja absorción de agua hace que las baldosas resistan al hielo. Esto podría resultar en estancamientos superficiales de agua, incluso si los materiales están instalados según las reglas del arte.



## WHITE



## GRAY





**R11  
CLASSE C**

DCOF >  
0,42 Wet

20 mm 3/4" ↑↓

### GRES FINE PORCELLANATO

FINE PORCELAIN STONEWARE/GRES CERAME FIN/FEINSTEINZEUG-KOLLEKTIONEN/GRES PORCELANICO FINO  
SQUADRATO - SQUARED - EQUARRI - REKTIFIZIERT - ESCUADRADO

| WALKS/1.0 | 20 mm 3/4" ↑↓   | COLOR | SURFACE  | 40x120                                 | 60x60                                  |
|-----------|---|-------|----------|--|--|
|           |   |       |          | 15 <sup>3/4"</sup> x47 <sup>1/4"</sup> | 23 <sup>5/8"</sup> x23 <sup>5/8"</sup> |
|           |   | WHITE | NATURALE | 740560                                 | 740558                                 |
|           |  | GRAY  | NATURALE | 740561                                 | 740559                                 |

### PEZZI SPECIALI

Special trims/Pièces spéciales/Formstücke  
Piezas especiales  
pag 152/155

| ISO 10545-4 | RESISTENZA ALLA FLESSIONE IN N/mm <sup>2</sup>   | valore medio   |
|-------------|--|--|
|             |   | N/mm <sup>2</sup> FLEXURAL STRENGTH TEST / RESISTANCE A LA FLEXION EN N/mm <sup>2</sup> / BIEGEFESTIGKEIT IN N/mm <sup>2</sup> / RESISTENCIA A LA FLEXION EN N/mm <sup>2</sup> |
|             | Forza di rottura in N (sp. > 7,5 mm) / Breaking strength in N (thickness > 7,5 mm) / Force de rupture en N (ép. > 7,5 mm) / Bruchlast in N (Dicke > 7,5 mm) / Fuerza de rotura en N (gr. > 7,5 mm) | valore medio<br>14000 N  |

| WALKS/1.0   | scatola - box |      |       | pallet |       |      |
|-------------|---------------|------|-------|--------|-------|------|
|             | pz            | mq   | kg    | box    | mq    | kg   |
| 40x120 20mm | 2             | 0,96 | 42,86 | 24     | 23,04 | 1060 |
| 60x60 20mm  | 2             | 0,72 | 32,15 | 30     | 21,60 | 990  |

# OUTDOOR 20mm PEZZI SPECIALI

SPECIAL TRIMS  
PIÈCES SPÉCIALES  
FORMSTÜKE  
PIEZAS ESPECIALES

CARATTERISTICHE TECNICHE





TECHNICAL FEATURES  
CARACTÉRISTIQUES TECHNIQUES  
TECHNISCHE EIGENSCHAFTEN  
CARACTERÍSTICAS TÉCNICAS

# Pezzi speciali Outdoor 20mm

Special trims/Pièces spéciales/Formstücke / Piezas especiales

Collections:

BUILDTECH/2.0 - EARTHECH  
INDUSTRIAL - STONTECH/4.0 - RAWTECH - WALKS/1.0

Collections:

BUILDTECH/2.0 - BIOTECH - CORETECH - EARTHECH  
STONTECH/4.0 - RAWTECH - PLIMATECH

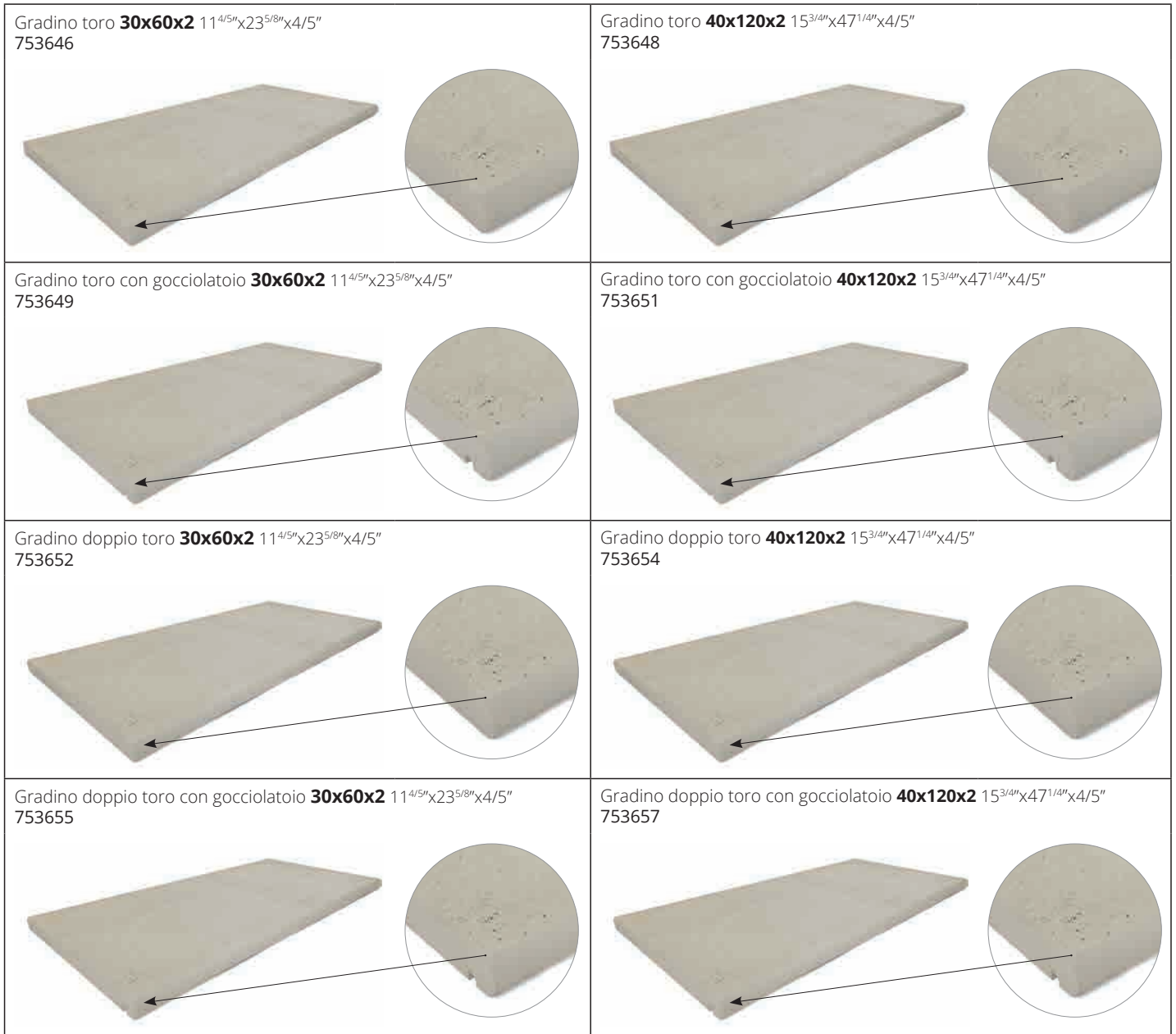

| PEZZI SPECIALI<br>OUTDOOR 20mm              | scatola - box |    |       | pallet |    |    |
|---|---------------|----|-------|--------|----|----|
|   | pz            | mq | kg    | box    | mq | kg |
| 30x60 gradino toro                          | 1             | -  | 10,00 | -      | -  | -  |
| 30x60 gradino toro con gocciolatoio         | 1             | -  | 10,00 | -      | -  | -  |
| 30x60 gradino doppio toro                   | 1             | -  | 10,00 | -      | -  | -  |
| 30x60 gradino doppio toro con gocciolatoio  | 1             | -  | 10,00 | -      | -  | -  |
| 40x120 gradino toro                         | 1             | -  | 25,00 | -      | -  | -  |
| 40x120 gradino toro con gocciolatoio        | 1             | -  | 25,00 | -      | -  | -  |
| 40x120 gradino doppio toro con gocciolatoio | 1             | -  | 25,00 | -      | -  | -  |
| 30x60 elemento ad elle                      | 1             | -  | 10,00 | -      | -  | -  |
| 30x60 elemento ad elle angolo dx/sx         | 1             | -  | 10,00 | -      | -  | -  |
| 60x60 elemento ad elle                      | 1             | -  | 20,00 | -      | -  | -  |
| 60x60 elemento ad elle angolo dx/sx         | 1             | -  | 20,00 | -      | -  | -  |
| 40x120 elemento ad elle                     | 1             | -  | 25,00 | -      | -  | -  |
| 40x120 elemento ad elle angolo dx/sx        | 1             | -  | 25,00 | -      | -  | -  |



Collections:  
 BUILDTECH/2.0 - EARTHECH - INDUSTRIAL  
 STONTECH/4.0 - RAWTECH - WALKS/1.0

Collections:  
 BUILDTECH/2.0 - BIOTECH - CORETECH - EARTHECH  
 STONTECH/4.0 - RAWTECH - PLIMATECH

Elemento ad Elle Angolo SX **30x60x8** 11<sup>4/5"</sup>x23<sup>5/8"</sup>x3<sup>1/8"</sup>  
 753852

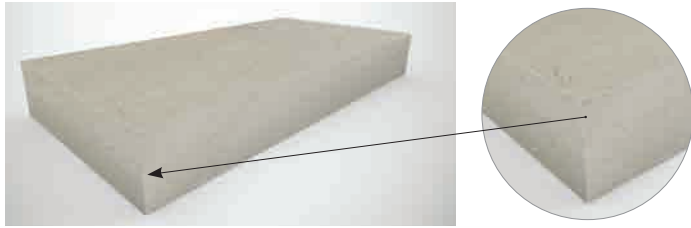

Elemento ad Elle Angolo SX **40x120x8** 15<sup>3/4"</sup>x47<sup>1/4"</sup>x3<sup>1/8"</sup>  
 753861

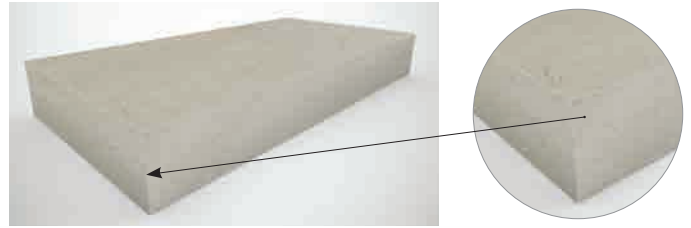

Elemento ad Elle **30x60x8** 11<sup>4/5"</sup>x23<sup>5/8"</sup>x3<sup>1/8"</sup>  
 753850

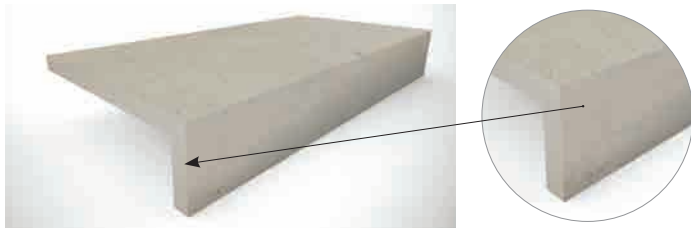

Elemento ad Elle **40x120x8** 15<sup>3/4"</sup>x47<sup>1/4"</sup>x3<sup>1/8"</sup>  
 753859

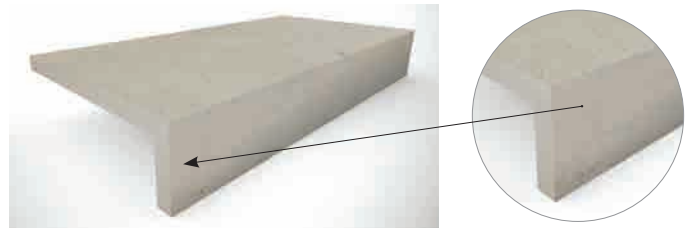

Elemento ad Elle Angolo DX **30x60x8** 11<sup>4/5"</sup>x23<sup>5/8"</sup>x3<sup>1/8"</sup>  
 753851

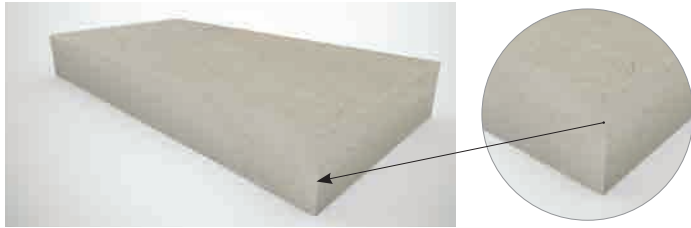

Elemento ad Elle Angolo DX **40x120x8** 15<sup>3/4"</sup>x47<sup>1/4"</sup>x3<sup>1/8"</sup>  
 753860

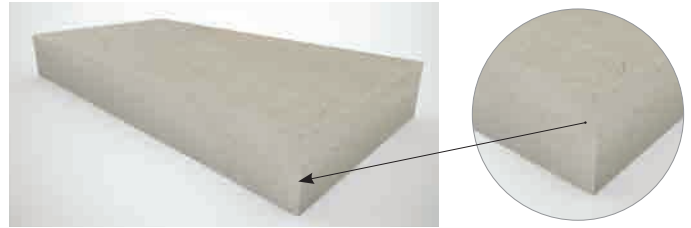

Elemento ad Elle Angolo SX **60x60x8** 23<sup>5/8"</sup>x23<sup>5/8"</sup>x3<sup>1/8"</sup>  
 753855

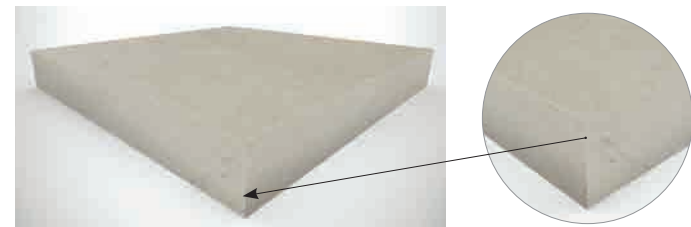

**Pezzi speciali e fondo possono differire in termini di tonalità, il bordo può presentare stratificazioni di tonalità diverse.**

Special pieces and field tiles may come in different shades, the slab's edge may show layers of differing hues.

Il peut y avoir des différences de tonalités entre les pièces spéciales et le fond, le bord pourrait présenter des stratifications de tonalités différentes.

Die Formteile können farblich von der Grundplatte abweichen, ihre Kanten können Schichtungen in unterschiedlichen Farbtönen aufweisen.

Piezas especiales y bases pueden diferir en términos de tonalidad, el borde puede presentar estratificaciones de diferente tonalidad.

Elemento ad Elle **60x60x8** 23<sup>5/8"</sup>x23<sup>5/8"</sup>x3<sup>1/8"</sup>  
 753853 ▲ FL-14000

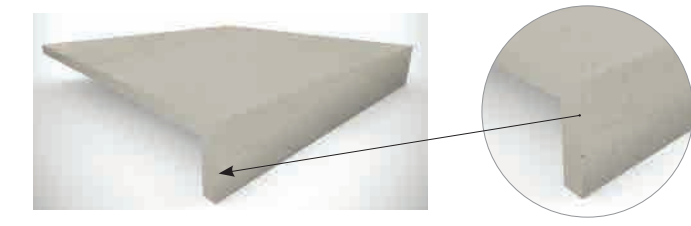

Elemento ad Elle Angolo DX **60x60x8** 23<sup>5/8"</sup>x23<sup>5/8"</sup>x3<sup>1/8"</sup>  
 753854

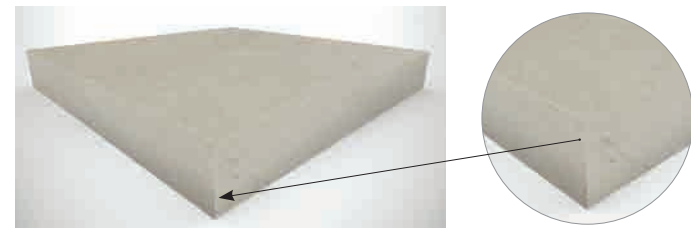

# **BORDO VASCA**

SWIMMING POOL EDGE  
BORD DE PISCINE  
BECKENRAND  
BORDE DE LA TINA



**CARATTERISTICHE TECNICHE**



TECHNICAL FEATURES  
CARACTÉRISTIQUES TECHNIQUES  
TECHNISCHE EIGENSCHAFTEN  
CARACTERÍSTICAS TÉCNICAS

# WAVE/SPECIALPIECES

BORDO VASCA / SWIMMING POOL EDGE / BORD DE PISCINE  
BECKENRAND / BORDE DE LA TINA

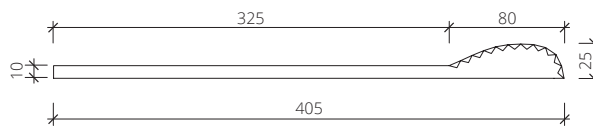
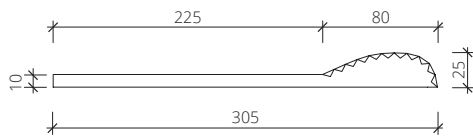
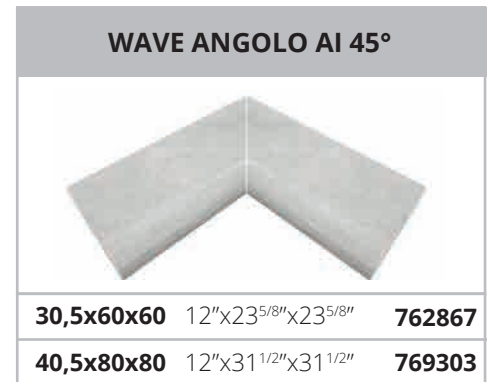
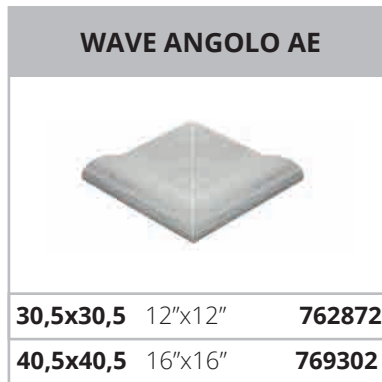
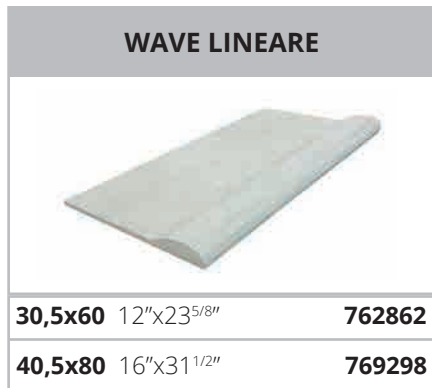

## BORDO PER PISCINA "WAVE"

Rivoluzionario pezzo speciale che, attraverso l'accostamento di una serie di listelli opportunamente conformati su un lato del pezzo, rende ottimale la tracimazione, il contenimento dell'acqua, nonché l'appiglio manuale. La flessibilità progettuale di questo pezzo consente di realizzare bordi con diversi materiali Florim selezionati tra le serie che presentano le più elevate proprietà antiscivolo a piedi nudi (classe A+B+C, rif. norma DIN 51097).

## "WAVE" SWIMMING POOL EDGE

Revolutionary border tile that, by placing together a set of suitably shaped strips on one side of the tile, makes an efficient overflow, containing the water and also offering a hand-grip. The flexibility of the design of this tile enables edges to be created with different Florim materials selected from the ranges that have the highest barefoot slip-resistance ratings (Class A+B+C, according to DIN 51097 standard).

## BORD POUR PISCINE « WAVE »

Pièce spéciale révolutionnaire qui, grâce à la juxtaposition d'une série de listels dûment disposés sur un côté de la pièce, optimise le débordement, le confinement de l'eau, ainsi que le point d'accroche avec les mains. La flexibilité de conception de cette pièce permet de réaliser des bords avec différents matériaux Florim sélectionnés parmi les séries dotées des plus hautes propriétés antidérapantes pieds nus (classe A+B+C, réf. norme DIN 51097).

## BECKENRANDSTEIN "WAVE"

Ein revolutionäres Spezialteil, das durch das Aneinandersetzen einer Reihe von Leisten, die an einer Seite des Spezialteils zweckmäßig geformt sind, eine ausgezeichnete Überflutung, Wassereindämmung und Griffkante bietet. Die flexible Projektanpassung dieses Spezialteils erlaubt die Gestaltung von Beckenrändern mit verschiedenen Florim-Materialien, ausgewählt unter den Produktserien mit der höchsten Barfuß-Rutschfestigkeit (Klasse A+B+C, Bezugsnorm DIN 51097).

## BORDE PARA PISCINA «WAVE»

Pieza especial revolucionaria que se remata por un lado con una serie de listones de forma especial, para ofrecer un desbordamiento y retención del agua óptimos, así como un excelente asidero manual. La flexibilidad de diseño de esta pieza permite realizar bordes con varios materiales de Florim, seleccionados entre las series que presentan las más altas propiedades antideslizantes con pies descalzos (clase A+B+C, ref. norma DIN 51097).



# OCEAN/SPECIALPIECES

BORDO VASCA / SWIMMING POOL EDGE / BORD DE PISCINE  
BECKENRAND / BORDE DE LA TINA

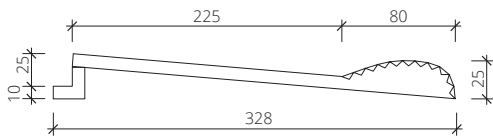
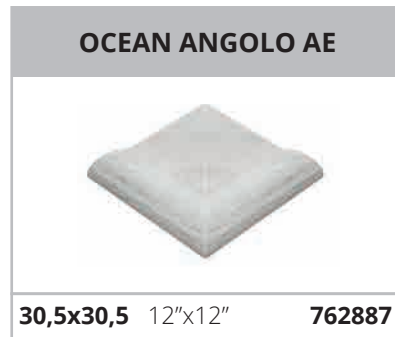

## BORDO PER PISCINA "OCEAN"

Innovativo e rivoluzionario pezzo speciale progettato appositamente per essere utilizzato come bordo piscina con sistema ad acqua traboccante a sfioro. E' composto da un pezzo che, attraverso l'accostamento di una serie di listelli opportunamente conformati su un lato del pezzo, rende ottimale la tracimazione, il contenimento dell'acqua, nonché l'appiglio manuale. La flessibilità progettuale di questo pezzo consente di realizzare bordi con diversi materiali Florim selezionati tra le serie che presentano le più elevate proprietà antiscivolo a piedi nudi (classe A+B+C, rif. norma DIN 51097). Questo pezzo speciale comprende anche l'angolare in porcellanato per appoggio e contenimento griglia.

## "OCEAN" SWIMMING POOL EDGE

Innovative, revolutionary border tile specially designed to be used as a swimming pool edge with overflow system. It comprises a piece that, by placing together a set of suitably shaped strips on one side of the tile, makes an efficient overflow, containing the water and also offering a hand-grip. The flexibility of the design of this tile enables edges with different Florim materials to be created, selecting them from the ranges that have the highest barefoot slip-resistance ratings (Class A+B+C, according to DIN 51097 standard). This special piece also includes the porcelain stoneware corner element for setting and containing the grating.

## BORD POUR PISCINE « OCEAN »

Pièce spéciale innovante et révolutionnaire spécialement conçue pour être utilisée comme bord de piscine à débordement avec système de trop-plein. Grâce à la juxtaposition d'une série de listels dûment disposés sur un de ses côtés, cette pièce, optimise le débordement, le confinement de l'eau, ainsi que le point d'accroche avec les mains. La flexibilité de conception de cette pièce permet de réaliser des bords avec différents matériaux Florim sélectionnés parmi les séries dotées des plus hautes propriétés antidérapantes pieds nus (classe A+B+C, réf. norme DIN 51097). Cette pièce spéciale comprend également une pièce d'angle en grès cérame pour le support et le confinement de la grille.

## BECKENRANDSTEIN "OCEAN"

Dieses innovative und revolutionäre Spezialteil wurde speziell für die Verwendung als Rand für Schwimmbecken mit Wasserüberlauftrinne entwickelt. Es besteht aus einem Teil, das durch das Aneinandersetzen einer Reihe von Leisten, die an einer Seite des Teils zweckmäßig geformt sind, eine ausgezeichnete Überflutung, Wassereindämmung und Griffkante bietet. Die flexible Projektanpassung dieses Spezialteils erlaubt die Gestaltung von Beckenrändern mit verschiedenen Florim-Materialien, ausgewählt unter den Produktserien mit der höchsten Barfuß-Rutschfestigkeit (Klasse A+B+C, Bezugsnorm DIN 51097). Dieses Spezialteil enthält auch das Eckstück aus Feinsteinzeug zur Aufnahme des Rostes.

## BORDE PARA PISCINA «OCEAN»

Pieza especial, innovadora y revolucionaria, diseñada específicamente para usarse como borde de piscina con sistema de agua desbordante. Consta de una pieza que se remata por un lado con una serie de listones de forma especial, para ofrecer un desbordamiento y retención del agua óptimos, así como un excelente asidero manual. La flexibilidad de diseño de esta pieza permite realizar bordes con varios materiales de Florim, seleccionados entre las series que presentan las más altas propiedades antideslizantes con pies descalzos (clase A+B+C, ref. norma DIN 51097). Esta pieza especial también incluye la pieza angular de porcelánico de apoyo y sujeción de la rejilla.

## CARATTERISTICHE - VANTAGGI TECNICI

1. Modularità a base 60/80 cm (in base alla collezione scelta).
2. Facilità di posa, con collanti di normale uso per la ceramica.
3. Elevata leggerezza.
4. Alta resistenza meccanica ai carichi.
5. Sicurezza allo scivolamento.
6. Costanza e precisione dimensionale.
7. Ergonomia che facilita l'appiglio manuale.
8. Conformazione che ottimizza la tracimazione e il contenimento dell'acqua.
9. Massima igiene.
10. Totale impermeabilità.
11. Possibilità di realizzazione con diverse collezioni antiscivolo Florim.
12. Ridotta incidenza nel costo complessivo della vasca.
13. Il taglio dei pezzi in cantiere, deve essere fatto con sistemi adeguati (es. taglio ad acqua con disco diamantato).

## TAGLI

E' possibile fornire pezzi tagliati a misura di varie forme e dimensioni. Prezzi e condizioni di vendita sono da stabilire, con specifica offerta da parte della divisione "FLORIM SOLUTIONS".

## CARACTÉRISTIQUES - AVANTAGES TECHNIQUES

1. Modularité à la base 60/ 80 cm (en fonction de la collection choisie)
2. Facilité de pose, avec des adhésifs à usage normal pour la céramique.
3. Légèreté élevée.
4. Haute résistance mécanique aux charges.
5. Antidérapant.
6. Constance et précision dimensionnelles.
7. Ergonomie qui facilite la prise manuelle.
8. Conformation qui optimise le débordement et le confinement de l'eau.
9. Hygiène maximale.
10. Étanchéité totale.
11. Possibilité de mise en œuvre avec diverses collections anti-dérapantes Florim.
12. Incidence réduite sur le coût global de la piscine.
13. La découpe des pièces sur le chantier doit être effectuée avec des systèmes adéquats (par ex. découpe à eau avec disque diamanté).

## PIÈCES COUPÉES

Il est possible de fournir des pièces coupées sur mesure de diverses formes et dimensions. Prix et conditions de vente à établir avec une offre spécifique de la part de la division «FLORIM SOLUTIONS».

## CARACTERÍSTICAS - VENTAJAS TÉCNICAS

1. Modularidad en base a 60/ 80 cm (según la colección elegida)
2. Facilidad de colocación, con encolados de uso normal para cerámicos.
3. Elevada ligereza.
4. Alta resistencia mecánica a las cargas.
5. Seguridad contra el deslizamiento.
6. Constancia y precisión dimensional.
7. Ergonomía que facilita el agarre manual.
8. Configuración que optimiza el desbordamiento y la contención del agua.
9. Máxima higiene.
10. Total impermeabilidad.
11. Posibilidad de realización con las distintas colecciones de antideslizantes Florim.
12. Reducida incidencia en el coste total de la tina.
13. El corte de las piezas en las obras se debe realizar con sistemas adecuados (por ejemplo: corte de agua con disco diamantado).

## CORTES

Es posible proveer piezas cortadas a la medida de varias formas y dimensiones. Los precios y condiciones de venta se deben fijar mediante una oferta específica de la división "FLORIM SOLUTIONS".

## TECHNICAL CHARACTERISTICS - ADVANTAGES

1. Modularity with 60/ 80 CM (based on the chosen collection)
2. Easy to lay with adhesives normally used for ceramic materials.
3. Ultra-light weight.
4. High mechanical load resistance.
5. Non-slip safety.
6. Dimensional constancy and precision.
7. Ergonomics that facilitate manual gripping.
8. Conformation that optimises the overflow and containment of water.
9. Maximum hygiene.
10. Total impermeability.
11. Possibility to create using different Florim antislip collections.
12. Reduced incidence on the total cost of the pool.
13. The cutting of the pieces on the work site must be done using suitable systems (e.g. water cut with diamond disk).

## CUTS

It is possible to supply pieces cut to measure in various shapes and sizes. Prices and sales conditions are to be stipulated with a specific offer by the FLORIM SOLUTIONS Division.



## MERKMALE - TECHNISCHE VORZÜGE

1. Modularität auf der Basis von 60/80 cm (basierend auf der ausgesuchten Kollektion)
2. Einfache Verlegung mit den üblichen Klebern für Keramik.
3. Äußerste Leichtigkeit.
4. Hohe mechanische Belastungsfestigkeit.
5. Rutschfestigkeit.
6. Maßbeständigkeit und -genauigkeit.
7. Ergonomische Form, die das Greifen mit der Hand erleichtert.
8. Beschaffenheit, die den Überlauf und die Eindämmung des Wassers optimiert.
9. Maximale Hygiene.
10. Vollkommene Wasserundurchlässigkeit.
11. Möglichkeit der Herstellung mit verschiedenen rutschfesten Serien von Florim.
12. Geringe Auswirkung auf die Gesamtkosten des Beckens.
13. Das Schneiden der Teile an der Baustelle hat mit geeigneten Systemen (z.B. Wasserstrahlschneiden mit Diamantscheibe) zu erfolgen.

## ZUSCHNITT

Es können nach Maß zugeschnittene Teile in verschiedenen Formen und Größen geliefert werden. Preise und Verkaufsbedingungen sind in speziellem Angebot der Abteilung "FLORIM SOLUTIONS" festzulegen.

## WAVE/OCEAN/PACKAGES

|                     |            | BOXES  |    |       | PALLETS  |    |    |
|---------------------|------------|--|----|-------|---|----|----|
|                     |            | PZ   | MQ | KG    | PZ  | MQ | KG |
| WAVE LINEARE        | 30,5x60    | 2  | -  | 4,50  | -   | -  | -  |
| WAVE LINEARE        | 40,5x80    | 2  | -  | 7,70  | -   | -  | -  |
| WAVE ANGOLO AE      | 30,5x30,5  | 1  | -  | 2,40  | -   | -  | -  |
| WAVE ANGOLO AE      | 40,5x40,5  | 1  | -  | 4,00  | -   | -  | -  |
| WAVE ANGOLO AI 45°  | 30,5x60x60 | 1  | -  | 6,50  | -   | -  | -  |
| WAVE ANGOLO AI 45°  | 40,5x80x80 | 1  | -  | 11,50 | -   | -  | -  |
| OCEAN LINEARE       | 33x60      | 2  | -  | 5,20  | -   | -  | -  |
| OCEAN LINEARE       | 33x80      | 2  | -  | 7,00  | -   | -  | -  |
| OCEAN ANGOLO AE     | 30,5x30,5  | 1  | -  | 2,40  | -   | -  | -  |
| OCEAN ANGOLO AI 45° | 33x60x60   | 1  | -  | 7,80  | -   | -  | -  |
| OCEAN ANGOLO AI 45° | 33x80x80   | 1  | -  | 10,50 | -   | -  | -  |



FLORIM OVERSIZE  
**magnUm**<sup>®</sup>

## **IMBALLI E DECORI**

PACKAGING AND DECORATIONS  
EMBALLAGES ET DÉCORS  
VERPACKUNGEN UND DEKORS  
EMBALAJES Y DECORACIONES

# TABELLA IMBALLI

PACKAGE TABLE/TABLEAU DE EMBALLAGES/TABELLE FORMATE/TABLA DE LOS EMBALAJES  
#6 SPESSORE / THICKNESS/ÉPAISSEUR/STÄRKE/ESPESOR

|                        |               |   | BOXES  |    |      |       | PALLET  |       |      |
|------------------------|---------------|---|---|----|------|-------|--|-------|------|
|                        |               |   | ML  | PZ | MQ   | KG    | BOX  | MQ    | KG   |
|                        | <b>80x80</b>  | 31 <sup>1/2</sup> "x31 <sup>1/2</sup> " | -   | 3  | 1,92 | 27,80 | 40   | 76,80 | 1140 |
|                        | <b>60x120</b> | 23 <sup>5/8</sup> "x47 <sup>1/4</sup> " | -   | 3  | 2,16 | 31,30 | 30   | 64,80 | 960  |
| <b>MOSAICO 1,5x3</b>   | <b>30x30</b>  | 11 <sup>4/5</sup> "x11 <sup>4/5</sup> " | -   | 11 | 1,00 | 16,50 | -  | -     | -    |
| <b>MOSAICO 7,5x7,5</b> | <b>30x30</b>  | 11 <sup>4/5</sup> "x11 <sup>4/5</sup> " | -   | 11 | 1,00 | 16,50 | -  | -     | -    |
| <b>MURETTO 7,5x15</b>  | <b>30x30</b>  | 11 <sup>4/5</sup> "x11 <sup>4/5</sup> " | -   | 11 | 1,00 | 16,50 | -  | -     | -    |
| <b>BATTISCOPIA</b>     | <b>4,6x80</b> | 1 <sup>4/5</sup> "x31 <sup>1/2</sup> "  | 14,40   | 18 | -    | 8,60  | -  | -     | -    |
|                        | <b>4,6x60</b> | 1 <sup>4/5</sup> "x23 <sup>5/8</sup> "  | 14,40   | 24 | -    | 8,60  | -  | -     | -    |

## DECORI/ DECORS

Note Imballo. Tutti i singoli pezzi tagliati vengono numerati con applicazione sulla parte a vista di un pezzo di nastro isolante dove è riportato il n° del pezzo. Le scatole sono rivestite internamente di polistirolo per garantire l'integrità dei singoli pezzi. Su ogni scatola è riportato: N° dei pezzi totali - Numerazione di ciascun pezzo. Sulla palette viene applicata una pallet card ed una busta in plastica contenente lo schema di montaggio. Per richieste di formati inferiori al modulo base (120x240 o 160x240), resta in vigore la richiesta di lavorazioni fuori standard. N. B. Il prezzo di listino del decoro si riferisce a formato standard. Eventuali lavorazioni su misura verranno valutate su richiesta. (Il servizio clienti è a disposizione per informazioni e ulteriori dettagli a riguardo).

Packing notes. Each individual cut piece is given a number. The piece number is shown on the exposed side of a strip of insulation tape. The boxes are padded on the inside with polystyrene to protect the individual pieces. Each box bears the following information: Total n° of pieces - Code number of each piece. The pallet comes with a pallet card and a plastic pouch containing the assembly diagram. For smaller sizes requests different from basic modules (120x240 or 160x240), you need to follow the procedure for requesting a non-standard format. N. B. The decor's price list refers to the standard format featuring one colour. Any custom-work will be assessed upon request. Please call our Customer Service for more information.

Remarques concernant l'emballage. Chaque pièce découpée est numérotée avec une application sur la partie visible d'un morceau de ruban isolant sur lequel figure le n° de la pièce. Les boîtes sont revêtues intérieurement de polystyrène afin de garantir l'intégrité de chaque pièce. Sur chaque boîte figurent: le nombre de pièces totales et la numérotation de chaque pièce. Une carte de la palette et un sachet en plastique contenant le schéma du montage sont appliqués sur la palette. Pour toute demande de formats inférieurs au module de base (120x240 ou 160x240), reste en vigueur la demande de hors standard. N. B. Le prix catalogue du décor se réfère au format standard. Les éventuels traitements sur mesure seront évalués sur demande. Le service clientèle est à votre disposition si vous avez besoin d'informations et de plus amples détails.

Verpackungshinweise. Alle geschneittenen einzelnen Teile werden nummeriert, wobei die Nummer des Teils auf der sichtbaren Seite eines Stücks Isolierband angebracht ist. Die Kartonverpackungen sind innen mit Polystyrol ausgelegt, um die Unversehrtheit der einzelnen Teile zu gewährleisten. Folgende Angaben befinden sich auf jedem Karton: Gesamtzahl der Teile Nummerierung jedes Teils. An der Palette sind eine Palettenkarte und ein Kunststoffbeutel mit dem Montageplan angebracht. Für Anfragen von kleineren Formaten als vom Standard vorgesehen (120x240 oder 160x240) gilt der übliche Bearbeitungsvorgang für Sonderanfertigungen. N. B. Der Listenpreis bezieht sich auf die Dekoration im Standard-Format, einfarbig. Eventuelle kundenspezifische Verarbeitungen werden auf Anfrage kalkuliert. Der Kundenservice steht für weitere Informationen und Einzelheiten hierzu jederzeit zur Verfügung.

Notas sobre el embalaje. Todas las partes cortadas se enumeran colocando en la parte a la vista de la pieza una cinta adhesiva donde se reproduce el n.º de la pieza. El interior de las cajas se reviste con poliestireno para garantizar la integridad de cada una de las piezas. Sobre cada caja se reproduce: N.º de las piezas totales - Numeración de cada pieza. En la paleta se coloca una "pallet card" y una bolsa plástica que contiene el esquema del montaje. Para pedidos de formatos inferiores a los módulos de base (120x240 o 160x240), es necesario solicitar las elaboraciones no estándar. N. B. El precio de catálogo del decoro se refiere al formato estándar. Las elaboraciones a medida se evaluarán bajo pedido. El servicio de atención al cliente está a su disposición para proporcionarle más información y detalles al respecto.

| TIPO / TYPE  |
|--|
| <b>A: CASSA / CRATE</b> cm 175x340x31h - 68 <sup>8/9</sup> "x133 <sup>6/7</sup> "x12 <sup>1/5</sup> "        |
| <b>B: CASSA / CRATE</b> cm 145x292x35h - 57"x115"x13 <sup>7/9</sup> "  |
| <b>C: CASSA / CRATE</b> cm 136x263x34h - 53 <sup>1/2</sup> "x103 <sup>1/2</sup> "x13 <sup>2/5</sup> "        |
| <b>D: CASSA / CRATE</b> cm 135x144x41h - 53 <sup>1/7</sup> "x56 <sup>2/3</sup> "x16 <sup>1/7</sup> "         |
| <b>E: CASSA / CRATE</b> cm 135x144x66h - 53 <sup>1/7</sup> "x56 <sup>2/3</sup> "x26"                         |
| <b>G: CASSA / CRATE</b> cm 174x183x41h - 68 <sup>1/2</sup> "x72x16 <sup>1/7</sup> "                          |
| <b>H/I: CAVALLETTO / A-FRAME</b> cm 73x330x200h - 28 <sup>3/4</sup> "x130"x78 <sup>3/4</sup> "               |
| <b>L: CAVALLETTO / A-FRAME</b> cm 75x339x186h - 29 <sup>1/2</sup> "x133 <sup>1/2</sup> "x73 <sup>2/9</sup> " |
| <b>M: CAVALLETTO / A-FRAME</b> cm 75x290x146h - 29 <sup>1/2</sup> "x114 <sup>1/6</sup> "x57 <sup>1/2</sup> " |
| <b>N: CAVALLETTO / A-FRAME</b> cm 75x250x146h - 29 <sup>1/2</sup> "x98 <sup>3/7</sup> "x57 <sup>1/2</sup> "  |
| <b>P: CAVALLETTO / A-FRAME</b> cm 75x250x160h - 29 <sup>1/2</sup> "x98 <sup>3/7</sup> "x63"                  |
| <b>R: CAVALLETTO / A-FRAME</b> cm 75x170x195h - 29 <sup>1/2</sup> "x67"x76 <sup>7/9</sup> "                  |

\*Le lastre sono contenute in scatole da 2 pezzi ciascuna / Packing for this item is 2 slabs per box / Les plaques sont contenues dans des boîtes de 2 pièces chacune. Die Platten sind in Kartons zu je 2 Stück verpackt. / Las baldosas están empaquetadas en cajas de 2 piezas cada una.

°per spedizioni > 12 scatole / for shipments > 12 boxes / pour les expéditions > 12 boîtes / für Versandmengen > 12 Schachteln / para envíos > 12 cajas.

°°per spedizioni ≤ 12 scatole / for shipments ≤ 12 boxes / pour les expéditions ≤ 12 boîtes / für Versandmengen ≤ 12 Schachteln / para envíos ≤ 12 cajas



# TABELLA IMBALLI

## PACKAGE TABLE/TABLEAU DE EMBALLAGES/TABELLE FORMATE/TABLA DE LOS EMBALAJES #6 SPESSORE / THICKNESS/ÉPAISSEUR/STÄRKE/ESPESOR

| TIPO<br>TYPE  | formato LASTRA<br>SLAB size   | LASTRA<br>SLAB |       | CASSA vuota<br>empty CRATE |       |        | CASSA piena<br>full CRATE | CAVALLETTO vuoto<br>empty A-Frame |        |        | CAVALLETTO pieno<br>full A-Frame |
|---|---|----------------|-------|----------------------------|-------|--------|---------------------------|-----------------------------------|--------|--------|----------------------------------|
|   |   | MQ             | KG    | PZ                         | MQ    | KG     | KG                        | PZ                                | MQ     | KG     | KG                               |
|    | <b>A</b><br><b>160x320</b><br>63"x126"  | 5,12           | 74,15 | 14                         | 71,68 | 140,5  | 1178,6                    | -                                 | -      | -      | -                                |
|    | <b>B</b><br><b>120x280</b><br>47 <sup>1/4</sup> "x110 <sup>1/4</sup> "  | 3,36           | 48,65 | 20                         | 67,20 | 90,00  | 1063                      | -                                 | -      | -      | -                                |
|    | <b>C (6mm)</b><br><b>120x240</b><br>47 <sup>1/4</sup> "x94 <sup>1/2</sup> "   | 2,88           | 41,70 | 20                         | 57,60 | 107,00 | 941                       | -                                 | -      | -      | -                                |
|   | <b>C (9mm)</b><br><b>120x240</b><br>47 <sup>1/4</sup> "x94 <sup>1/2</sup> "   | 2,88           | 69,50 | 14                         | 40,32 | 107,00 | 1080                      | -                                 | -      | -      | -                                |
|    | <b>D (6mm)</b><br><b>120x120</b><br>47 <sup>1/4</sup> "x47 <sup>1/4</sup> "   | 1,44           | 20,85 | 24*                        | 34,56 | 50,00  | 550                       | -                                 | -      | -      | -                                |
|   | <b>D (9mm)</b><br><b>120x120</b><br>47 <sup>1/4</sup> "x47 <sup>1/4</sup> "   | 1,44           | 33,28 | 20*                        | 28,80 | 50,00  | 715                       | -                                 | -      | -      | -                                |
|    | <b>E (6mm)</b><br><b>120x120</b><br>47 <sup>1/4</sup> "x47 <sup>1/4</sup> "   | 1,44           | 20,70 | 48*                        | 69,12 | 70,00  | 1065,1                    | -                                 | -      | -      | -                                |
|   | <b>E (9mm)</b><br><b>120x120</b><br>47 <sup>1/4</sup> "x47 <sup>1/4</sup> "   | 1,44           | 23,11 | 40*                        | 57,60 | 70,00  | 994                       | -                                 | -      | -      | -                                |
|   | <b>G</b><br><b>160x160</b><br>63"x63"   | 2,56           | 37,06 | 24                         | 61,44 | 45,00  | 934,44                    | -                                 | -      | -      | -                                |
|  | <b>H</b><br><b>160x320</b><br>63"x126"  | 5,12           | 74,15 | -                          | -     | -      | -                         | 44                                | 225,28 | 220,00 | 3482,6                           |
|   | <b>I</b><br><b>120x280</b><br>47 <sup>1/4</sup> "x110 <sup>1/4</sup> "  | 3,36           | 48,65 | -                          | -     | -      | -                         | 44                                | 147,84 | 220,00 | 2360,6                           |
|  | <b>L</b><br><b>160x320</b><br>63"x126"<br>Cavalletto in lamiera zincata<br>Zinc-plated sheet A-frame                                      | 5,12           | 74,15 | -                          | -     | -      | -                         | 44                                | 225,28 | 120,00 | 3382,6                           |
|  | <b>M</b><br><b>120x280</b><br>47 <sup>1/4</sup> "x110 <sup>1/4</sup> "<br>Cavalletto in lamiera zincata<br>Zinc-plated sheet A-frame      | 3,36           | 48,65 | -                          | -     | -      | -                         | 44                                | 147,84 | 108,5  | 2249,1                           |
|  | <b>N (6mm)</b><br><b>120x240</b><br>47 <sup>1/4</sup> "x94 <sup>1/2</sup> "<br>Cavalletto in lamiera zincata<br>Zinc-plated sheet A-frame | 2,88           | 41,70 | -                          | -     | -      | -                         | 44                                | 126,72 | 92,5   | 1941,5                           |
|   | <b>N (9mm)</b><br><b>120x240</b><br>47 <sup>1/4</sup> "x94 <sup>1/2</sup> "<br>Cavalletto in lamiera zincata<br>Zinc-plated sheet A-frame | 2,88           | 69,50 | -                          | -     | -      | -                         | 28                                | 80,64  | 92,5   | 2038,5                           |
|  | <b>P (6mm)</b><br><b>120x240</b><br>47 <sup>1/4</sup> "x94 <sup>1/2</sup> "   | 2,88           | 41,70 | -                          | -     | -      | -                         | 44                                | 126,72 | 170,00 | 2004,8                           |
|   | <b>P (9mm)</b><br><b>120x240</b><br>47 <sup>1/4</sup> "x94 <sup>1/2</sup> "   | 2,88           | 69,50 | -                          | -     | -      | -                         | 28                                | 80,64  | 170,00 | 2116                             |
|  | <b>R</b><br><b>160x160</b><br>63"x63"   | 2,56           | 37,07 | -                          | -     | -      | -                         | 44                                | 112,64 | 160,00 | 1791,08                          |

## ESEMPI DI PERSONALIZZAZIONE DECORI IN DIMENSIONE 120X240

EXAMPLES OF DECORS CUSTOMIZATIONS 120X240 SIZE

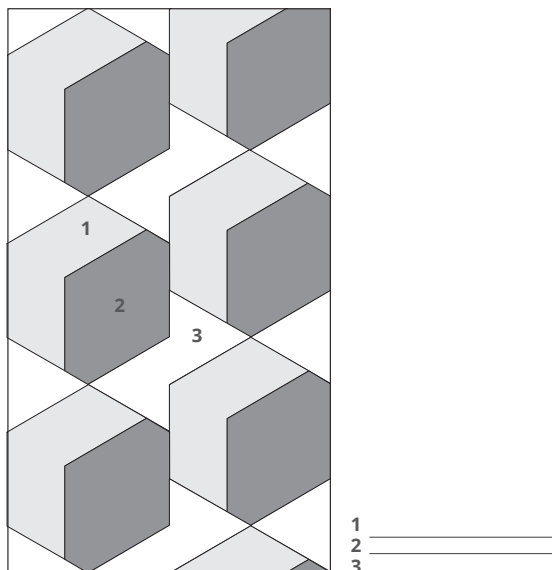

In ogni decoro è possibile selezionare materie e superfici combinandole nel modo in cui si desidera (vedi esempio).  
Il decoro può essere adattato a qualsiasi misura richiesta.

For each decor you can select materials and surfaces combining them in the way you prefer (see example).  
The decoration can be adapted to any requested measurements.

### ABBINAMENTI CONSIGLIATI.

SUGGESTED COMBINATIONS.

#### INDUSTRIAL

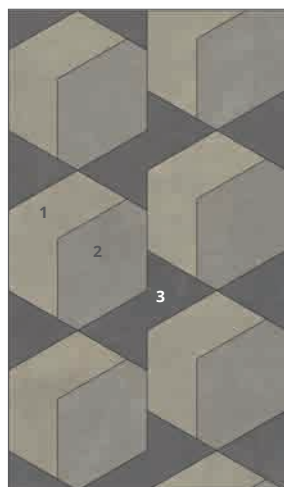

FLA / 749488

1 / INDUSTRIAL / SAGE  
2 / INDUSTRIAL / STEEL  
3 / INDUSTRIAL / PLOMB

#### FLOWTECH



FLOWTECH / AGED BRONZE

**ESEMPI DI PERSONALIZZAZIONE DECORI**  
 EXAMPLES OF DECORS CUSTOMIZATIONS

**FLOWTECH  
 INDUSTRIAL**

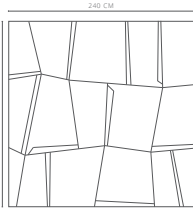
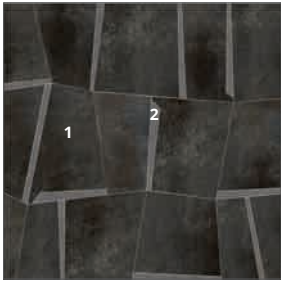

**FLB / 749489**

1 / **FLOWTECH** / BURNISHED  
 2 / **INDUSTRIAL** / PLOMB

**INDUSTRIAL**

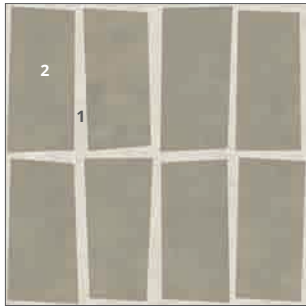

**FLC / 749490**

1 / **INDUSTRIAL** / IVORY  
 2 / **INDUSTRIAL** / SAGE

**BIOTECH**



**FLE A / B / C / 750220**

**BIOTECH / LAPIS GREIGE**



**FLE A / 749497**



**FLE B / 749498**



**FLE C / 749499**

# ESEMPI DI PERSONALIZZAZIONE DECORI IN DIMENSIONE 160X240

EXAMPLES OF DECORS CUSTOMIZATIONS 160X240 SIZE

## INDUSTRIAL



FLD A/B/C/D/E/F / 750219

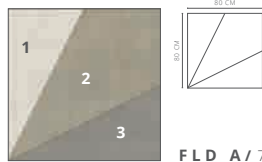

FLD A / 749491

1/ INDUSTRIAL / IVORY  
2/ INDUSTRIAL / SAGE  
3/ INDUSTRIAL / STEEL



FLD B / 749492

1/ INDUSTRIAL / IVORY  
2/ INDUSTRIAL / SAGE  
3/ INDUSTRIAL / STEEL  
4/ INDUSTRIAL / MOKA

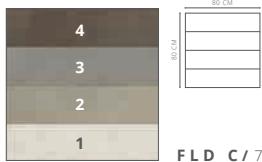

FLD C / 749493

1/ INDUSTRIAL / IVORY  
2/ INDUSTRIAL / SAGE  
3/ INDUSTRIAL / STEEL  
4/ INDUSTRIAL / MOKA

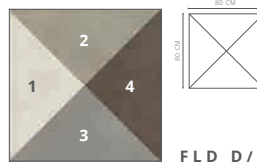

FLD D / 749494

1/ INDUSTRIAL / IVORY  
2/ INDUSTRIAL / SAGE  
3/ INDUSTRIAL / STEEL  
4/ INDUSTRIAL / MOKA



FLD E / 749495

1/ INDUSTRIAL / IVORY  
2/ INDUSTRIAL / SAGE  
3/ INDUSTRIAL / STEEL  
4/ INDUSTRIAL / MOKA



FLD F / 749496

1/ INDUSTRIAL / IVORY  
2/ INDUSTRIAL / SAGE  
3/ INDUSTRIAL / STEEL  
4/ INDUSTRIAL / MOKA

## BUILDTECH/2.0 INDUSTRIAL

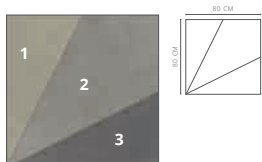

1/ INDUSTRIAL / SAGE  
2/ INDUSTRIAL / STEEL  
3/ INDUSTRIAL / PLOMB

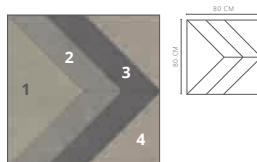

1/ INDUSTRIAL / SAGE  
2/ INDUSTRIAL / STEEL  
3/ INDUSTRIAL / PLOMB  
4/ BUILDTECH/2.0 / BUILD MUD CE

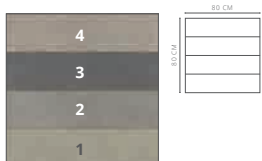

1/ INDUSTRIAL / SAGE  
2/ INDUSTRIAL / STEEL  
3/ INDUSTRIAL / PLOMB  
4/ BUILDTECH/2.0 / BUILD MUD CE

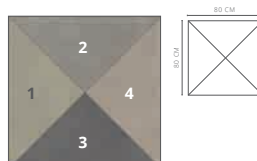

1/ INDUSTRIAL / SAGE  
2/ INDUSTRIAL / STEEL  
3/ INDUSTRIAL / PLOMB  
4/ BUILDTECH/2.0 / BUILD MUD CE

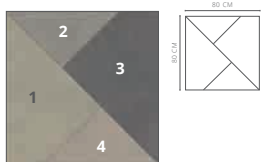

1/ INDUSTRIAL / SAGE  
2/ INDUSTRIAL / STEEL  
3/ INDUSTRIAL / PLOMB  
4/ BUILDTECH/2.0 / BUILD MUD CE

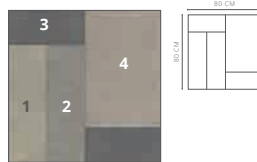

1/ INDUSTRIAL / SAGE  
2/ INDUSTRIAL / STEEL  
3/ INDUSTRIAL / PLOMB  
4/ BUILDTECH/2.0 / BUILD MUD CE



**ESEMPI DI PERSONALIZZAZIONE DECORI IN DIMENSIONE 120X240**  
**EXAMPLES OF DECORS CUSTOMIZATIONS 120X240 SIZE**

**BIOTECH**



**FLF / 749500**

**BIOTECH / CREMA STONE**

**INDUSTRIAL**



**FLG / 749501**

**1/ INDUSTRIAL / STEEL**  
**2/ INDUSTRIAL / PLOMB**

**INDUSTRIAL**

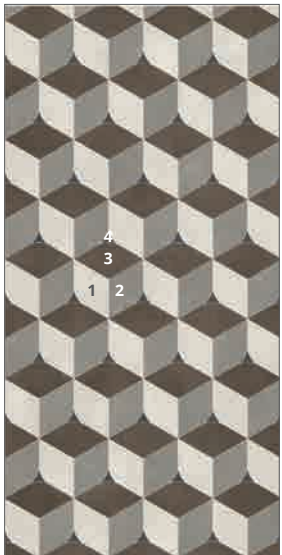

**FLH / 749502**

**1/ INDUSTRIAL / IVORY**  
**2/ INDUSTRIAL / STEEL**  
**3/ INDUSTRIAL / MOKA**  
**4/ INDUSTRIAL / PLOMB**

**INDUSTRIAL**



**FLI / 749503**

**1/ INDUSTRIAL / SAGE**  
**2/ INDUSTRIAL / STEEL**

**ESEMPI DI PERSONALIZZAZIONE DECORI IN DIMENSIONE 120X240**

EXAMPLES OF DECORS CUSTOMIZATIONS 120X240 SIZE

**BUILDTECH/2.0**

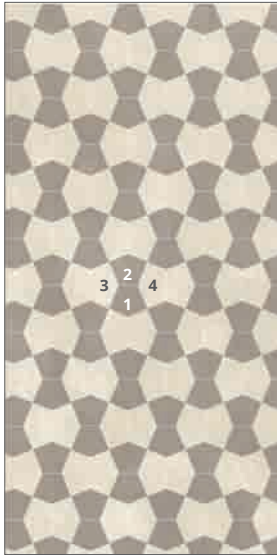

**FLL / 749504**

- 1/ BUILDTECH/2.0 / BUILD MUD CE
- 2/ BUILDTECH/2.0 / BUILD MUD CE
- 3/ BUILDTECH/2.0 / BUILD WHITE CE
- 4/ BUILDTECH/2.0 / BUILD WHITE CE

**BUILDTECH/2.0**

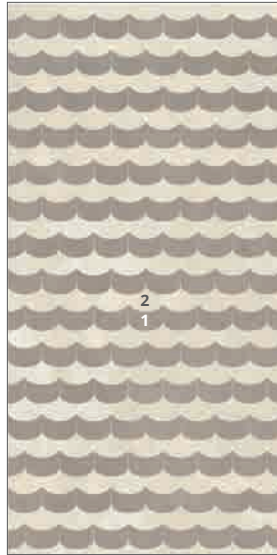

**FLM / 749505**

- 1/ BUILDTECH/2.0 / BUILD MUD CE
- 2/ BUILDTECH/2.0 / BUILD WHITE CE

**INDUSTRIAL  
BIOTECH**

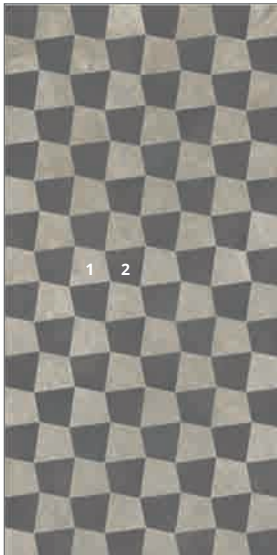

**FLN / 749506**

- 1/ BIOTECH / LAPIS GREIGE
- 2/ INDUSTRIAL / PLOMB

**INDUSTRIAL**



**FLO / 749507**

- 1/ INDUSTRIAL / MOKA
- 2/ INDUSTRIAL / TAUPE
- 3/ INDUSTRIAL / IVORY

## ESEMPI DI PERSONALIZZAZIONE DECORI

EXAMPLES OF DECORS CUSTOMIZATIONS

### BUILDTECH/2.0

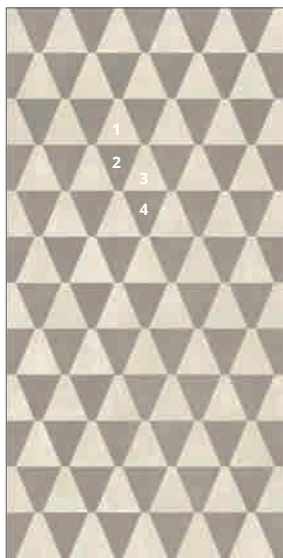

FLP / 749508

- 1/ BUILDTECH/2.0 / BUILD WHITE CE
- 2/ BUILDTECH/2.0 / BUILD MUD CE
- 3/ BUILDTECH/2.0 / BUILD WHITE CE
- 4/ BUILDTECH/2.0 / BUILD MUD CE

## ESEMPI DI PERSONALIZZAZIONE DECORI IN DIMENSIONE 265X240

EXAMPLES OF DECORS CUSTOMIZATIONS 265X240 SIZE

### INDUSTRIAL / BUILDTECH/2.0

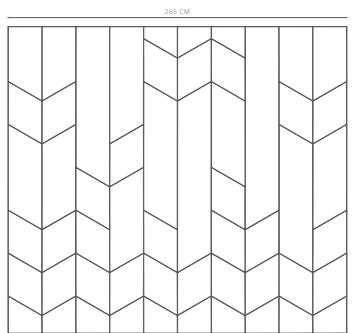
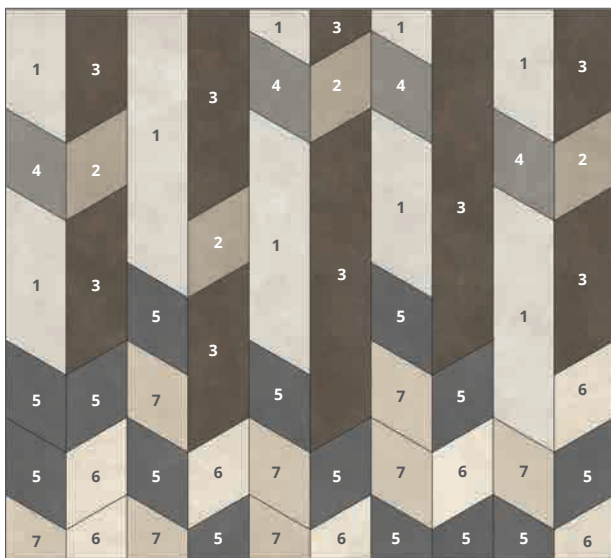

FLQ / 749509

- 1/ INDUSTRIAL / IVORY
- 2/ INDUSTRIAL / TAUPE
- 3/ INDUSTRIAL / MOKA
- 4/ INDUSTRIAL / STEEL
- 5/ INDUSTRIAL / PLOMB
- 6/ BUILDTECH/2.0 / BUILD WHITE CE
- 7/ BUILDTECH/2.0 / BUILD BONE CE

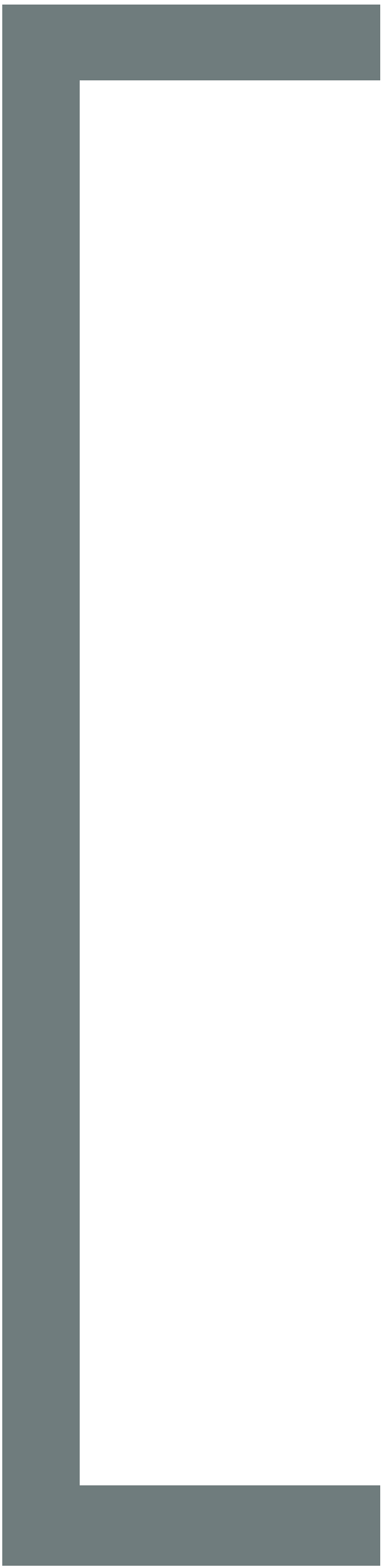



FLORIM OVERSIZE  
**magnUm**<sup>®</sup>

MODERN DESIGN  
PERSPECTIVES ARE  
CHANGING: AMAZING  
SIZES IN A THICKNESS  
OF JUST 6 MM,  
LIGHT, VERSATILE  
AND STRONG, WITH  
EXTRAORDINARY  
AESTHETIC APPEAL.

**GRAPHICS**

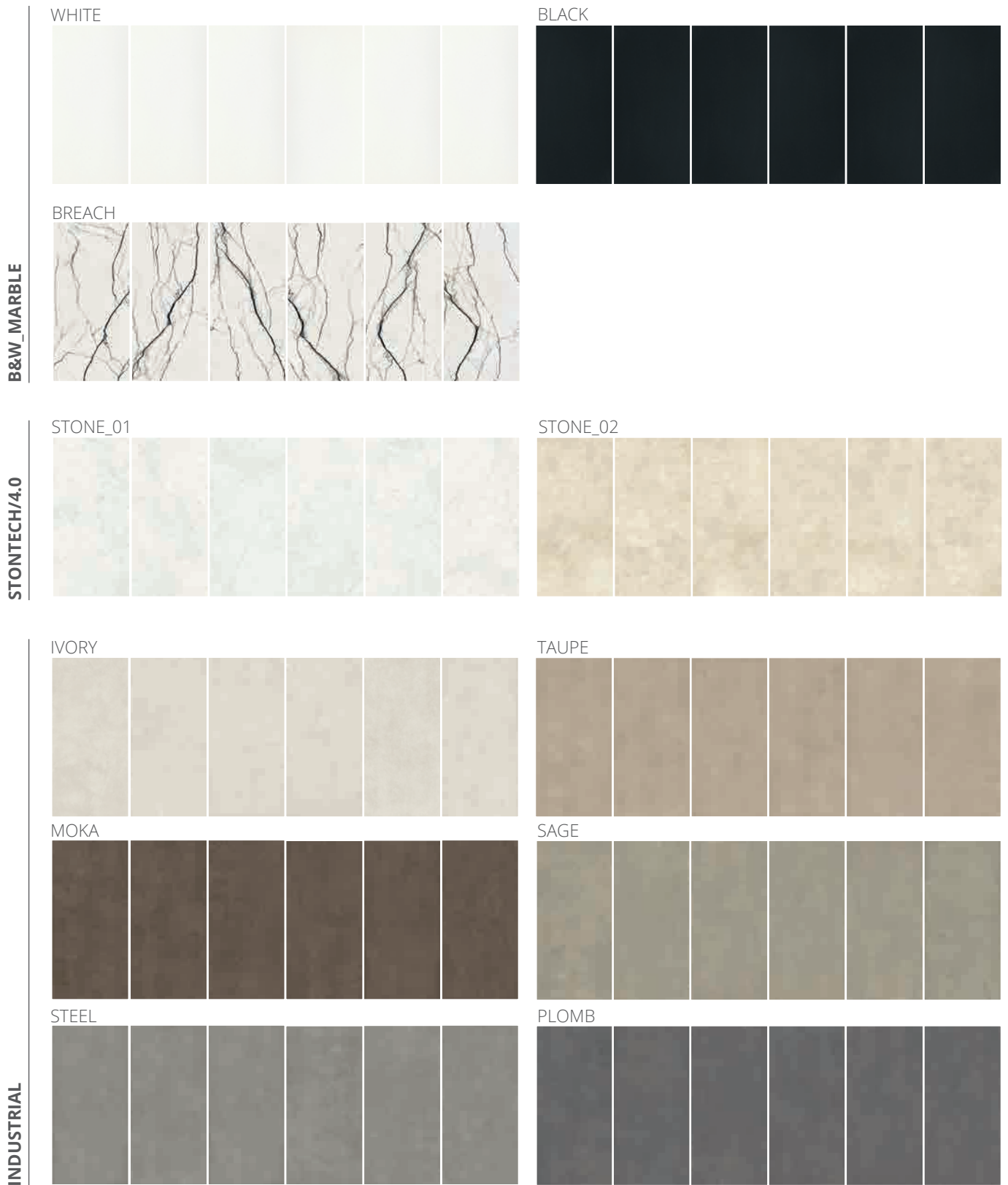

**Le immagini riportate non rappresentano necessariamente il numero di grafiche del prodotto. Il numero di grafiche è variabile in funzione del formato e del colore di riferimento.**  
 Images do not necessarily represent the number of patterns in the product's range. The number of different patterns varies according to size and color of the item. / Les images reportées ne représentent pas forcément le nombre de graphismes du produit. Leur nombre varie en fonction du format et de la couleur choisie. / Die Abbildungen geben keine bindende Auskunft bzgl. der Anzahl verschiedener Grafiken. Die Anzahl der Grafiken ist abhängig von Format und Farbe der jeweiligen Kollektion. / Las imágenes mostradas no representan necesariamente el número de gráficas del producto. El número de gráficas varía en función del formato y del color.

FLOWTECH

RUSSET



AGED BRONZE



BURNISHED



RAWTECH

RAW-WHITE



RAW-DUST



BIOTECH

CREMA STONE



STONEWOOD



LAPIS GREIGE



SERIZZO STONE

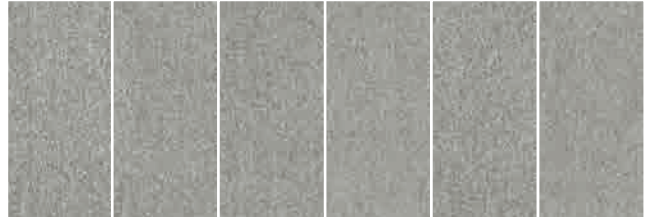

SOAP STONE



PLIMAWHITE/01



PLIMAWHITE/02

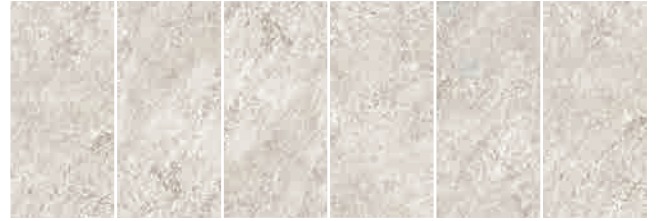

PLIMAWHITE/03

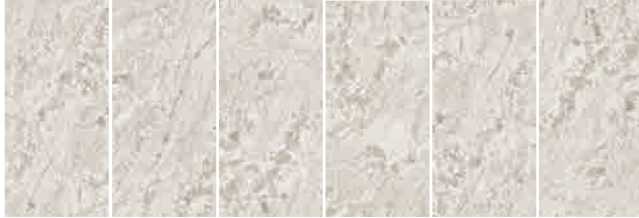

PLIMABEIGE/01



PLIMABEIGE/02



PLIMABEIGE/03



PLIMAGRAY/01



PLIMAGRAY/02



PLIMAGRAY/03

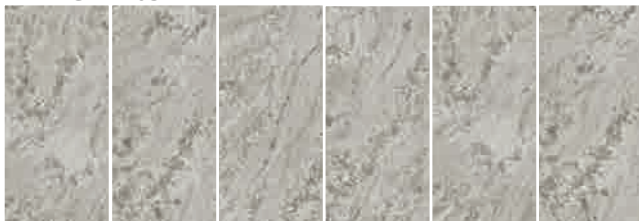

PLIMATECH

**Le immagini riportate non rappresentano necessariamente il numero di grafiche del prodotto. Il numero di grafiche è variabile in funzione del formato e del colore di riferimento.**  
 Images do not necessarily represent the number of patterns in the product's range. The number of different patterns varies according to size and color of the item. / Les images reportées ne représentent pas forcément le nombre de graphismes du produit. Leur nombre varie en fonction du format et de la couleur choisis. / Die Abbildungen geben keine bindende Auskunft bzgl. der Anzahl verschiedener Grafiken. Die Anzahl der Grafiken ist abhängig von Format und Farbe der jeweiligen Kollektion. / Las imágenes mostradas no representan necesariamente el número de gráficas del producto. El número de gráficas varía en función del formato y del color.



FLAME LIGHT

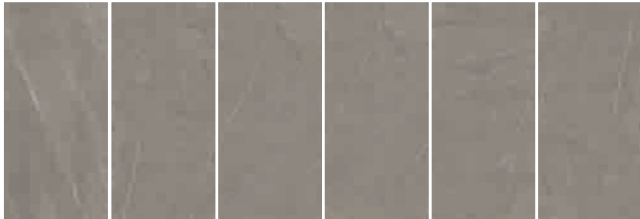

BRUSHED LIGHT

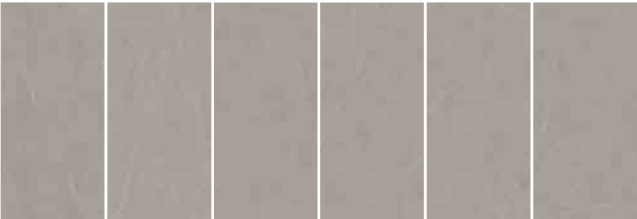

SATIN DARK

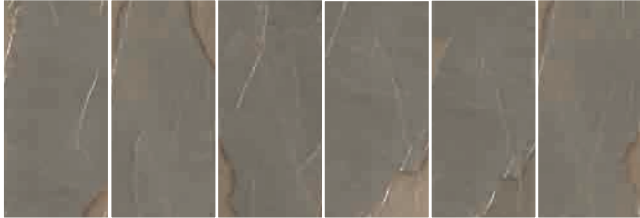

FLAME DARK



BUILD\_WHITE CE

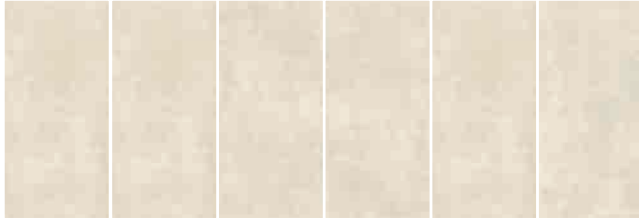

BUILD\_BONE CE



BUILD\_MUD CE

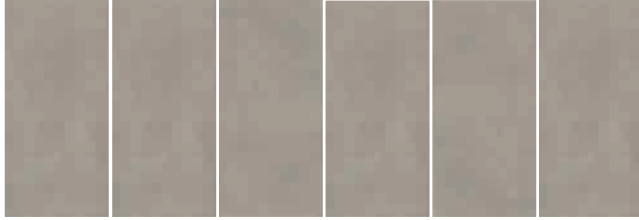

BUILD\_COAL CE

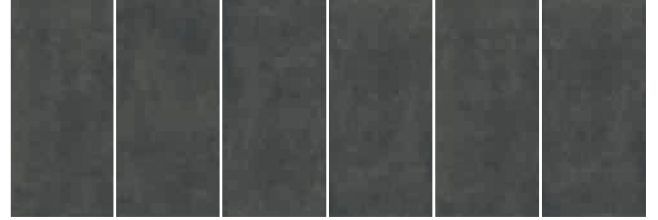

CREAM



MUSTARD

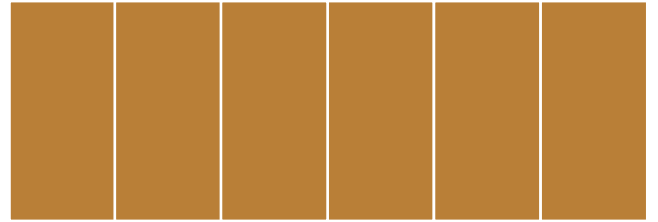

SCARLET

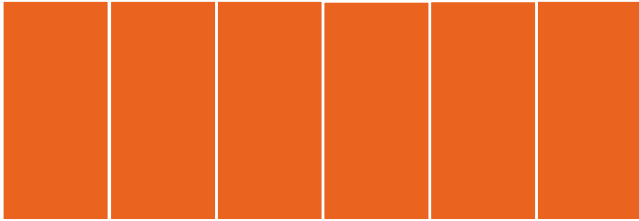

CRIMSON



FUCHSIA

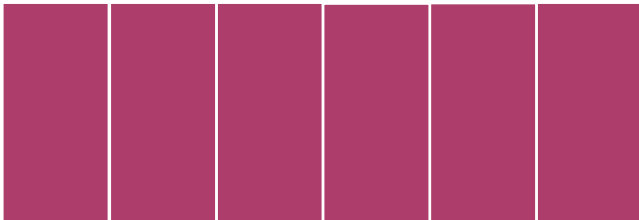

BURGUNDY

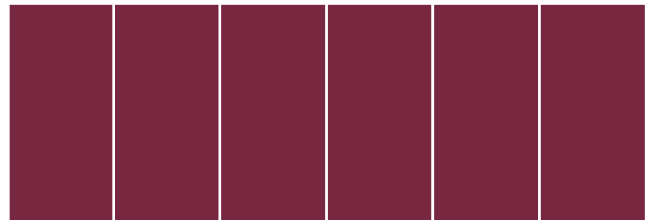

SKY

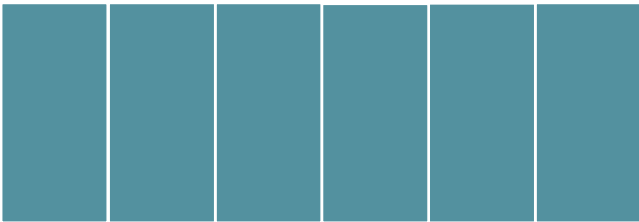

MIDNIGHT

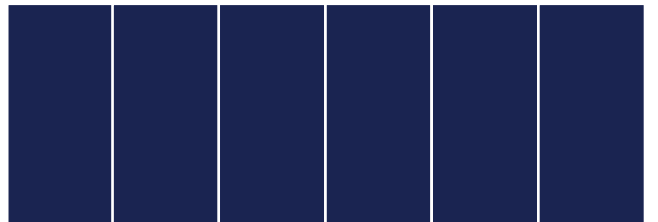

TEAL

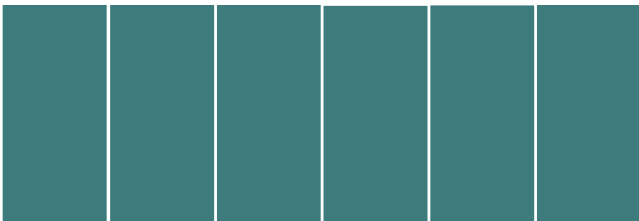

BOTTLE

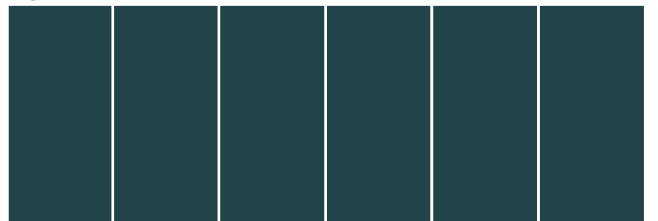

PUMICE\_GROUND

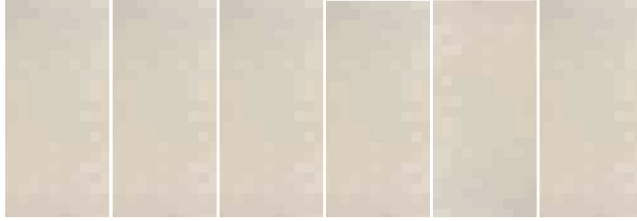

PUMICE\_FLAKES



DESERT\_GROUND



DESERT\_FLAKES



FOG\_GROUND



FOG\_FLAKES

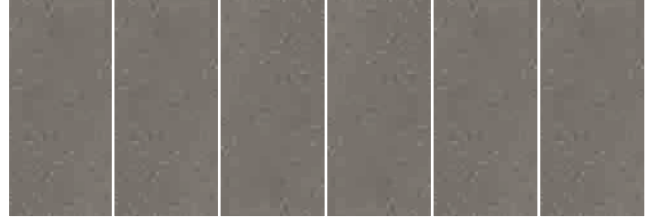

CARBON\_GROUND

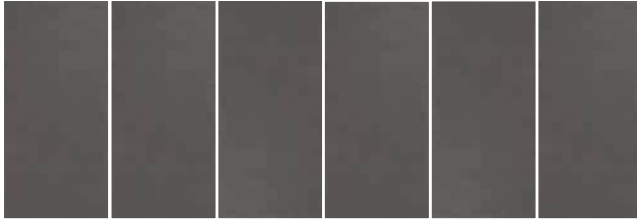

CARBON\_FLAKES



SAVANNAH\_GROUND

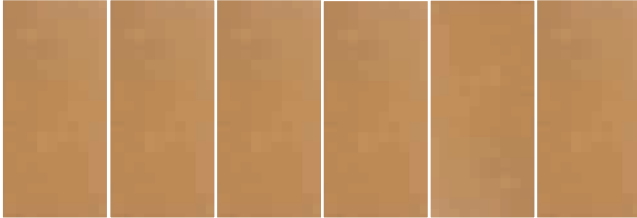

SAVANNAH\_FLAKES



OUTBACK\_GROUND

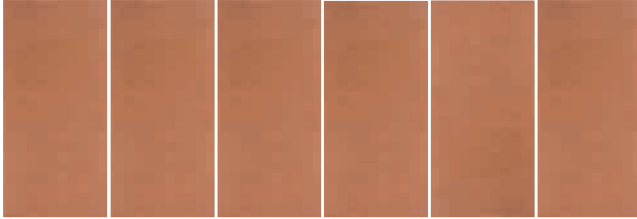

OUTBACK\_FLAKES



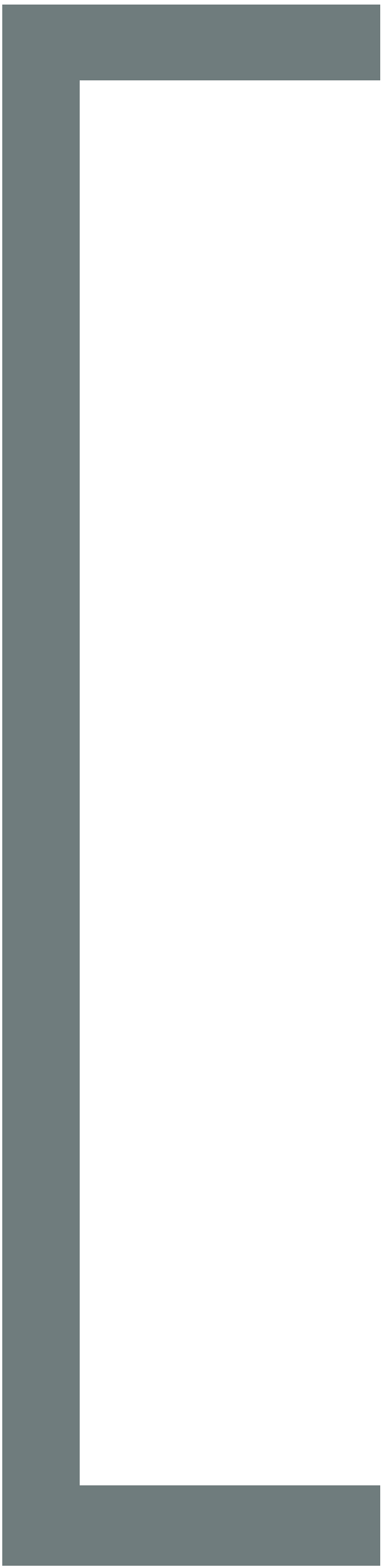



# CARATTERISTICHE TECNICHE

TECHNICAL FEATURES  
CARACTÉRISTIQUES TECHNIQUES  
TECHNISCHE EIGENSCHAFTEN  
CARACTERISTICAS TÉCNICAS

6mm

# BUILDTECH/2.0 - FLOWTECH

6 mm 1/4"

GRES FINE PORCELLANATO/FINE PORCELAIN STONEWARE/GRES CERAME FIN/FEINSTEINZEUG-KOLLEKTIONEN/GRES PORCELANICO FINO  
SQUADRATO - SQUARED - EQUARRI - REKTIFIZIERT - ESQUADRADO

| CARATTERISTICHE TECNICHE - TECHNICAL CHARACTERISTICS - CARACTERISTIQUES TECHNIQUES - TECHNISCHE EIGENSCHAFTEN - CARACTERÍSTICAS TÉCNICAS   |   |  |                           |   |                        |                              |                        |   |
|--|---|--|---------------------------|---|------------------------|------------------------------|------------------------|---|
| Lastre in gres fine porcellanato non smaltato. Piastrelle di ceramica pressate a secco. Caratteristiche di qualità secondo i test di controllo previsti dalla norma EN 14411-ISO 13006 Appendice G gruppo Bia UGL. / Unglazed porcelain stoneware slabs. Dry-pressed ceramic tiles. Quality specifications, according to control tests of EN 14411-ISO 13006 Appendix G group Bia UGL. / Dalles en grés cérame fin non émaillé. Carreaux céramiques pressés à sec. Caractéristiques de qualité d'après les essais de contrôle norme EN 14411-ISO 13006 Appendice G groupe Bia UGL. / Nicht glasierte und vollständig gesinterte Feinsteinzeugplatten. Trocken gepresste Keramikfliesen. Qualitätseigenschaften nach Normen EN 14411-ISO 13006 Anhang G Gruppe Bia UGL. / Planchas de gres porcelánico fino no esmaltado. Baldosas de cerámica rensadas en seco. Características de calidad según las Normas EN 14411-ISO 13006 Apéndice G grupo Bia UGL. |   | PRESCRIZIONE<br>STANDARD REQUIREMENTS<br>PRESCRIPTIONS<br>ANFORDERUNGEN<br>PRESCRIPCION  |                           | RISULTATI TESTS<br>TEST RESULTS<br>RESULTATS DES ESSAIS<br>PRÜFERGEBNIS<br>RESULTADOS TESTS |                        |                              |                        | RIFERIMENTO NORMA<br>REFERENCE STANDARD<br>RÉFÉRENCE NORME<br>STANDARWERT<br>REFERENCIA NORMA |
|  |   | N ≥ 15 cm  |                           | BUILDTECH/2.0   |                        | FLOWTECH                     |                        |   |
|  |   | (%)  | (mm)                      | NATURALE MATTE  | R+PTV                  | NATURALE MATTE               | R+PTV                  |   |
|  | LUNGHEZZA E LARGHEZZA: DEVIAZIONE AMMISSIBILE, IN %, DELLA DIMENSIONE MEDIA DI OGNI PIASTRELLA DALLA DIM. DI FABBRICAZIONE / LENGTH AND WIDTH: ADMITTED DEVIATION, IN %, OF THE AVERAGE SIZE OF EACH TILE FROM THE PRODUCTION DIMENSIONS / LONGUEUR ET LARGEUR : MARGE DE TOLÉRANCE, EN %, ENTRE LA DIMENSION MOYENNE DE CHAQUE CARREAU ET LA DIM. DE FABRICATION / LANGE UND BREITE: ZULASSIGE ABWEICHUNG DES DURCHSCHNITTMÄßES JEDER FLESE VOM HERSTELLMAß IN PROZENTEN / LARGO Y ANCHO: DESVIACION ADMISIBLE, EN %, DEL TAMAÑO MEDIO DE CADA BALDOSA A PARTIR DEL TAMAÑO DE FABRICACION. | Squadrato ISO 13006  | ±0,3 %                    | ±1,0 mm   | ±0,15 %                |                              | ISO 10545-2            |   |
|  | DEVIAZIONE AMMISSIBILE, IN PERCENTO, DELLO SPESSORE MEDIO DI OGNI PIASTRELLA DALLA DIMENSIONE DI FABBRICAZIONE / ADMITTED DEVIATION, IN %, OF THE AVERAGE THICKNESS OF EACH TILE FROM THE PRODUCTION DIMENSIONS / MARGE DE TOLÉRANCE, EN POURCENTAGE, ENTRE L'ÉPAISSEUR MOYENNE DE CHAQUE CARREAU ET LA DIMENSION DE FABRICATION / ZULASSIGE ABWEICHUNG DER DURCHSCHNITTSDICKE JEDER FLESE VOM HERSTELLMAß IN PROZENTEN / DESVIACION ADMISIBLE, EN TANTO POR CIENTO, DEL GROSOR MEDIO DE CADA BALDOSA A PARTIR DEL TAMAÑO DE FABRICACION.   | Squadrato ISO 13006  | ±5 %                      | ±0,5 mm   | ±5 %                   |                              | ISO 10545-2            |   |
|  | DEVIAZIONE MASSIMA DI RETTILINEARITÀ, IN PERCENTO, IN RAPPORTO ALLE DIMENSIONI DI FABBRICAZIONE / CORRESPONDENT / MAXIMUM STRAIGHTNESS DEVIATION, IN %, IN RELATION TO THE CORRESPONDING PRODUCTION DIMENSIONS / MARGE DE TOLÉRANCE DE RECTITUDE, EN POURCENTAGE, PAR RAPPORT AUX DIMENSIONS DE FABRICATION CORRESPONDANTES / ZULASSIGE HOCHSTABWEICHUNG DER KANTENGERADHEIT IM VERHÄLTNIS ZU DEN ENTSPRECHENDEN HERSTELLMAßEN IN PROZENTEN / DESVIACION MÁXIMA DE RECTITUD, EN TANTO POR CIENTO, EN RELACION CON EL TAMAÑO DE FABRICACION CORRESPONDIENTE.                                 | Squadrato ISO 13006  | ±0,3 %                    | ±0,8 mm   | ±0,10 %                |                              | ISO 10545-2            |   |
|  | DEVIAZIONE MASSIMA DI ORTOGONALITÀ, IN PERCENTO, IN RAPPORTO ALLE DIMENSIONI DI FABBRICAZIONE / CORRESPONDENT MAXIMUM RIGHT-ANGLE DEVIATION, IN %, IN RELATION TO THE CORRESPONDING PRODUCTION DIMENSIONS / MARGE DE TOLÉRANCE D'ANGULARITÉ, EN POURCENTAGE, PAR RAPPORT AUX DIMENSIONS DE FABRICATION / HOCHSTABWEICHUNG DER RECHTWINKELIGKEIT IM VERHÄLTNIS ZU DEN ENTSPRECHENDEN HERSTELLMAßEN IN PROZENTEN / DESVIACION MÁXIMA DE LA ORTOGONALIDAD, EN TANTO POR CIENTO, EN RELACION CON EL TAMAÑO DE FABRICACION CORRESPONDIENTE.  | Squadrato ISO 13006  | ±0,3 %                    | ±1,5 mm   | ±0,20 %                |                              | ISO 10545-2            |   |
|  | PLANARITÀ (CURVATURA DEL CENTRO, DELLO SPIGOLO E SVERGOLAMENTO) / FLATNESS (CURVING IN THE MIDDLE, CORNER AND WARPING) / PLANÉITÉ (COURBURE CENTRALE, DE L'ARÊTE ET GAUCHISSEMENT) / EBENFLACHIGKEIT (KRÜMMUNG DER MITTE, DER KANTE UND VERWINDUNG) / PLANITUD (CURVATURA DEL CENTRO, DE LA ARISTA Y ABARQUILLAMIENTO).   | Squadrato ISO 13006  | ±0,4 %                    | ±1,8 mm   | ±0,20 %                |                              | ISO 10545-2            |   |
|  | QUALITÀ DELLA SUPERFICIE / SURFACE QUALITY / QUALITÉ DE LA SURFACE / QUALITÄT DER OBERFLÄCHE / CALIDAD DE LA SUPERFICIE.  | Il 95% min delle piastrelle deve essere esente da difetti visibili. / At least 95% of the tiles must be free from visible flaws. 95% min des carreaux ne doivent présenter aucun défaut visible. Mindestens 95% der Fliesen müssen frei von sichtbaren min. / el 95% de las baldosas tiene que estar exento de defectos visibles.    |                           | CONFORME/CONFORMING<br>CONFORME/KONFORM/CONFORME  |                        | ISO 10545-2                  |                        |   |
|  | MASSA D'ACQUA ASSORBITA IN % / % WATER ABSORPTION - MASSE D'EAU ABSORBÉE EN % / WASSERAUFNAHME IN % / MASA DE AGUA ABSORBIDA EN %   |  | < 0,5%                    | valore medio 0,08%  |                        | ISO 10545-3                  |                        |   |
|  | FORZA DI ROTTURA IN N (sp. < 7,5 mm) - BREAKING STRENGTH IN N (thickness < 7,5 mm) / FORCE DE RUPTURE EN N (ép. < 7,5 mm) / BRUCHLAST IN N (Dicke < 7,5 mm) / FUERZA DE ROTURA EN N (gr. < 7,5 mm).   |  | ≥ 700 N                   | valore medio 1350 N   |                        | ISO 10545-4                  |                        |   |
|  | RESISTENZA ALLA FLESSIONE IN N/mm <sup>2</sup> / N/mm <sup>2</sup> FLEXURAL STRENGTH TEST / RÉSISTANCE A LA FLEXION EN N/mm <sup>2</sup> / BIEGESTÄRKE IN N/mm <sup>2</sup> / RESISTENCIA A LA FLEXIÓN EN N/mm <sup>2</sup>   |  | 35 MIN. N/mm <sup>2</sup> | valore medio 52 N/mm <sup>2</sup>   |                        | ISO 10545-4                  |                        |   |
|  | RESISTENZA ALL'ABRASIONE PROFONDA DELLE PIASTRELLE NON SMALTATE / RESISTANCE TO DEEP ABRASION OF UNGLAZED TILES / RESISTANCE A L'ABRASION PROFONDE DES CARREAUX NON ÉMAILLÉS / TIEFENABRIEFESTIGKEIT UNGLASIERTER FLESEN / RESISTENCIA A LA ABRASION PROFUNDA DE LAS BALDOSAS SIN ESMALTAR.   |  | < 175 mm <sup>3</sup>     | valore medio 140 mm <sup>3</sup>  |                        | ISO 10545-6                  |                        |   |
|  | RESISTENZA AGLI SBALZI TERMICI / THERMAL SHOCKS RESISTANT / RÉSISTANCE AUX VARIATIONS THERMIQUES / TEMPERATURWECHSELBESTÄNDIGKEIT / RESISTENCIA AL CHOQUE TÉRMICO.  | Metodo di prova disponibile / Available testing method<br>Méthode d'essai disponible / Verfügbare Prüfmethode<br>Método de ensayo disponible   |                           | RESISTE - RÉSISTANT<br>RÉSISTE - ERFÜLLT - RESISTE  |                        | ISO 10545-9                  |                        |   |
|  | RESISTENZA AL GELO / FROST RESISTANCE / RÉSISTANCE AU GEL / FROSTSICHERHEIT / RESISTENCIA A LA HELADA   | RICHIESTA - REQUIRED<br>REQUIRE - GEFORDERT - REQUERIDA  |                           | RESISTE - RÉSISTANT<br>RÉSISTE - ERFÜLLT - RESISTE  |                        | ISO 10545-12                 |                        |   |
|  | RESISTENZA ALLE MACCHIE / RESISTANCE TO STAINING / RÉSISTANCE AUX TACHES / FLECKENABWEISEND / RESISTENCIA A LAS MANCHAS.  | Metodo di prova disponibile / Available testing method<br>Méthode d'essai disponible / Verfügbare Prüfmethode<br>Método de ensayo disponible   |                           | Classe 4-5  | Classe 4-5             | Classe 4-5                   | Classe 4               |   |
|  | RILASCIO DI SOSTANZE PERICOLOSE / RELEASE OF HAZARDOUS SUBSTANCES / REJET DE SUBSTANCES DANGEREUSES / FREISETZUNG GEFAHRLICHER STOFFE / LIBERACIÓN DE SUSTANCIAS PELIGROSAS / CADMIO (in mg/dm <sup>2</sup> ) - PIOMBO (in mg/dm <sup>2</sup> )   | VALORE DICHIARATO PER SUPERFICIE GL CON IMPEGHI SU PAVI DI LAVORO / DECLARED VALUE FOR GL SURFACES USED ON WORKTOPS / VALEUR DÉCLARÉE POUR SURFACES GL UTILISÉES SUR PAVI DE TRAVAIL / ANGEBOBENEN WERT FÜR GL OBERFLÄCHEN ZUM GEBRAUCH ALS ARBEITSPLATZEN / VALOR DECLARADO PARA ACABADOS GL UTILIZADOS PARA SUPERFICIES DE TRABAJO |                           | CONFORME/CONFORMING<br>CONFORME/KONFORM/CONFORME  |                        | DM-1-2-2007-Reg-CE-1935-2004 |                        |   |
|  | RESISTENZA A BASSE CONCENTRAZIONI DI ACIDI E ALCALI / RESISTANCE TO LOW CONCENTRATIONS OF ACIDS AND ALKALIS / RESISTANCE A BASSES CONCENTRATIONS D'ACIDES ET ALCALIS / WIDERSTAND GEGEN NIEDRIGE KONZENTRATIONEN VON SAUREN UND LAUGEN. / RESISTENCIA A BAJAS CONCENTRACIONES DE ACIDOS Y ALCALIS.  | COME DICHIARATO DAL PRODUTTORE<br>SEE MANUFACTURER'S DECLARATION<br>SELON DECLARATION DU PRODUCTEUR<br>ENTSPRECHEND DER HERSTELLERANGABEN TAL COMO DECLARA EL FABRICANTE   |                           | LA  | LA-LB                  | LA-LB                        | LA-LB                  |   |
|  | RESISTENZA AI PRODOTTI CHIMICI DI USO DOMESTICO E AGLI ADDITIVI PER PISCINA / RESISTENCE TO DOMESTIC CHEMICAL PRODUCTS AND ADDITIVES FOR SWIMMING POOLS / RESISTANT AUX PRODUITS CHIMIQUES A USAGE DOMESTIQUE ET AUX ADDITIFS POUR PISCINE / WIDERSTAND GEGEN HAUSHALTSCHIMIKALIEN UND / SCHWIMMBADZUSATZSTOFFEN / RESISTENCIA A PRODUCTOS PARA LIMPIEZA DOMESTICA Y ADITIVOS PARA PISCINAS   | B min  |                           | A   |                        | ISO 10545-13                 |                        |   |
|  | COEFFICIENTE D'ATTRITO (SCIOLOSITÀ) / FRICTION COEFFICIENT (SLIPPERINESS) / COEFFICIENT DE FRICTION (GLISSEMENT) / REIBUNGSKOEFFIZIENT (SCHLUPFRIGKEIT) / COEFICIENTE DE ANTI DESLIZAMIENTO.  | -  |                           | 6° < α ≤ 10° R9   | 10° < α ≤ 19° R10      | 6° < α ≤ 10° R9              | 10° < α ≤ 19° R10      |   |
|  |   | -  |                           | 12° ≤ α < 18° classe A  | 18° ≤ α < 24° classe B | -                            | 18° ≤ α < 24° classe B |   |
|  |   | -  |                           | > 0,42 wet  |                        | DCOF ANSI A 326.3            |                        |   |
|  |   | -  |                           | -   | PTV >36 wet slider 96  | -                            | PTV >36 wet slider 96  |   |











Per un effetto ottimale della posa, florim suggerisce di mantenere 2 mm di fuga per pose monoformato e 3 mm per combinare formati misti / For optimal installation results, florim recommends maintaining a joint of 2 mm 1/16" for single format installations and 3 mm 1/8" to combine mixed formats / Pour réatter les meilleurs résultats de la pose du produit, florim conseille 2 mm de jointe pour les combinaisons de formats mixtes / Um einen optimalen effekt beim verlegen zu erzielen empfehlt florim eine 2 mm fuge bei einformatigen verlegungen und 3 mm fuge bei formatkombinationen / Para lograr los máximos resultados en la posa del producto, florim aconseja 2 mm de junta en aplicaciones monoformato y 3 mm en combinaciones de formatos mixtos.

# B&W\_MARBLE - STONTECH/4.0











GRES FINE PORCELLANATO/FINE PORCELAIN STONEWARE/GRES CERAME FIN/FEINSTEINZEUG-KOLLEKTIONEN/GRES PORCELANICO FINO  
SQUADRATO - SQUARED - EQUARRI - REKTIFIZIERT - ESQUADRADO

6 mm 1/4" 

## CARATTERISTICHE TECNICHE - TECHNICAL CHARACTERISTICS - CARACTERISTIQUES TECHNIQUES - TECHNISCHE EIGENSCHAFTEN - CARACTERÍSTICAS TÉCNICAS

| Lastre in gres fine porcellanato non smaltato. Piastrelle di ceramica pressate a secco. Caratteristiche di qualità secondo i test di controllo previsti dalla norma EN 14411-ISO 13006 Appendice G gruppo Bia UGL. / Unglazed porcelain stoneware slabs. Dry-pressed ceramic tiles. Quality specifications, according to control tests of EN 14411-ISO 13006 Appendix G group Bia UGL. / Dalles en grès cérame fin non émaillé. Carreaux céramiques pressés à sec. Caractéristiques de qualité d'après les essais de contrôle norme EN 14411-ISO 13006 Appendice G groupe Bia UGL. / Nicht glasierte und vollständig gesinterte Feinsteinzeugplatten. Trocken gepreschte Keramikfliesen. Qualitätseigenschaften nach Normen EN 14411-ISO 13006 Anhang G Gruppe Bia UGL. / Planchas de gres porcelánico fino no esmaltado. Baldosas de cerámica resandadas en seco. Características de calidad según las Normas EN 14411-ISO 13006 Apéndice G grupo Bia UGL. |   | PRESCRIZIONE STANDARD REQUIREMENTS PRESCRIPTIONS ANFORDERUNGEN PRESCRIPCION |   | RISULTATI TESTS TEST RESULTS RESULTATS DES ESSAIS PRÜFERGEBNIS RESULTADOS TESTS |  |                |  |          | RIFERIMENTO NORMA REFERENCE STANDARD RÉFÉRENCE NORME STANDARDWERT REFERENCIA NORMA |                              |
|---|---|---|---|---|--|----------------|--|----------|--|------------------------------|
|   |   | N ≥ 15 cm   |   | B&W_MARBLE  |  | STONTECH/4.0   |  |          |  |                              |
|   |   | (%)   | (mm)  | NATURALE  | HIGH GLOSSY                                      | NATURALE MATTE | HIGH GLOSSY  | R+PTV    |  |                              |
|   | LUNGHEZZA E LARGHEZZA: DEVIAZIONE AMMISSIBILE, IN %, DELLA DIMENSIONE MEDIA DI OGNI PIASTRELLA DALLA DIM. DI FABBRICAZIONE / LENGTH AND WIDTH: ADMITTED DEVIATION, IN %, OF THE AVERAGE SIZE OF EACH TILE FROM THE PRODUCTION DIMENSIONS / LONGUEUR ET LARGEUR - MARGE DE TOLÉRANCE, EN %, ENTRE LA DIMENSION MOYENNE DE CHAQUE CARREAU ET LA DIM. DE FABRICATION / LÄNGE UND BREITE: ZULÄSSIGE ABWEICHUNG DES DURCHSCHNITTMASSES JEDER FLIESE VOM HERSTELLMAß IN PROZENTEN / LARGO Y ANCHO: DESVIACION ADMISIBLE, EN %, DEL TAMAÑO MEDIO DE CADA BALDOSA A PARTIR DEL TAMAÑO DE FABRICACIÓN. | Squadrato ISO 13006   | ±0,3 %  | ±1,0 mm   |  |                | ±0,15 %  |          | ISO 10545-2  |                              |
|   | DEVIAZIONE AMMISSIBILE, IN PERCENTO, DELLO SPESSORE MEDIO DI OGNI PIASTRELLA DALLA DIMENSIONE DI FABBRICAZIONE / ADMITTED DEVIATION, IN %, OF THE AVERAGE THICKNESS OF EACH TILE FROM THE PRODUCTION DIMENSIONS / MARGE DE TOLÉRANCE, EN POURCENTAGE, ENTRE L'ÉPAISSEUR MOYENNE DE CHAQUE CARREAU ET LA DIMENSION DE FABRICATION / ZULÄSSIGE ABWEICHUNG DER DURCHSCHNITTSDICKE JEDER FLIESE VOM HERSTELLMAß IN PROZENTEN / DESVIACION ADMISIBLE, EN TANTO POR CIENTO, DEL GROSOR MEDIO DE CADA BALDOSA A PARTIR DEL TAMAÑO DE FABRICACIÓN.  | Squadrato ISO 13006   | ±5 %  | ±0,5 mm   |  |                | ±5 %   |          | ISO 10545-2  |                              |
|   | DEVIAZIONE MASSIMA DI RETTILINEARITÀ IN PERCENTO, IN RAPPORTO ALLE DIMENSIONI DI FABBRICAZIONE CORRISPONDENTI / MAXIMUM STRAIGHTNESS DEVIATION, IN %, IN RELATION TO THE CORRESPONDING PRODUCTION DIMENSIONS / MARGE DE TOLÉRANCE DE RECTITUDE, EN POURCENTAGE, PAR RAPPORT AUX DIMENSIONS DE FABRICATION CORRÉSPONDANTES / ZULÄSSIGE HOCHSTABWEICHUNG DER KANTENGERADHEIT IM VERHÄLTNIS ZU DEN ENTSPRECHENDEN HERSTELLMAßEN IN PROZENTEN / DESVIACION MÁXIMA DE RECTITUD, EN TANTO POR CIENTO, EN RELACION CON EL TAMAÑO DE FABRICACIÓN CORRRESPONDIENTE.                                    | Squadrato ISO 13006   | ±0,3 %  | ±0,8 mm   |  |                | ±0,10 %  |          | ISO 10545-2  |                              |
|   | DEVIAZIONE MASSIMA DI ORTOGONALITÀ, IN PERCENTO, IN RAPPORTO ALLE DIMENSIONI DI FABBRICAZIONE CORRISPONDENTI / MAXIMUM RIGHT-ANGLE DEVIATION, IN %, IN RELATION TO THE CORRESPONDING PRODUCTION DIMENSIONS / MARGE DE TOLÉRANCE D'ANGULARITÉ, EN POURCENTAGE, PAR RAPPORT AUX DIMENSIONS DE FABRICATION / HOCHSTABWEICHUNG DER RECHTWINKLIGKEIT IM VERHÄLTNIS ZU DEN ENTSPRECHENDEN HERSTELLMAßEN IN PROZENTEN / DESVIACION MÁXIMA DE LA ORTOGONALIDAD, EN TANTO POR CIENTO, EN RELACION CON EL TAMAÑO DE FABRICACIÓN CORRRESPONDIENTE.   | Squadrato ISO 13006   | ±0,3 %  | ±1,5 mm   |  |                | ±0,20 %  |          | ISO 10545-2  |                              |
|   | PLANARITÀ (CURVATURA DEL CENTRO, DELLO SPIGOLO E SVERGOLAMENTO) / FLATNESS (CURVING IN THE MIDDLE, CORNER AND WARPING) / PLANEITÉ (COUBURE CENTRALE, DE L'ARÊTE ET GAUCHISSEMENT) / EBENFLÄCHIGKEIT (KRÜMMUNG, DER MITTE, DER KANTE UND VERWINDUNG) / PLANITUD (CURVATURA DEL CENTRO, DE LA ARISTÁ Y ABARQUILLAMIENTO).   | Squadrato ISO 13006   | ±0,4 %  | ±1,8 mm   |  |                | ±0,20 %  |          | ISO 10545-2  |                              |
|   | QUALITÀ DELLA SUPERFICIE / SURFACE QUALITY / QUALITÉ DE LA SURFACE / QUALITÄT DER OBERFLÄCHE / CALIDAD DE LA SUPERFICIE.  |   | Il 95% min delle piastrelle deve essere esente da difetti visibili. / At least 95% of the tiles must be free from visible flaws. 95% min des carreaux ne doivent présenter aucun défaut visible. Mindestens 95% der Fliesen müssen frei von sichtbaren Mängeln. / el 95% de las baldosas tiene que estar exento de defectos visibles. |   |  |                | CONFORME/CONFORMING<br>CONFORME/KONFORM/CONFORME   |          | ISO 10545-2  |                              |
|    | MASSA D'ACQUA ASSORBITA IN % / % WATER ABSORPTION - MASSE D'EAU ABSORBÉE EN % / WASSERAUFNAHME IN % / MASA DE AGUA ABSORBIDA EN %   |   | < 0,5%  |   |  |                | valore medio 0,08 %                                |          | ISO 10545-3  |                              |
|   | FORZA DI ROTTURA IN N (sp. < 7,5 mm) - BREAKING STRENGTH IN N (thickness < 7,5 mm) / FORCE DE RUPTURE EN N (ép. < 7,5 mm) / BRUCHLAST IN N (Dicke < 7,5 mm) / FUERZA DE ROTURA EN N (gr. < 7,5 mm)  |   | ≥ 700 N   |   |  |                | valore medio<br>1350 N                             |          | ISO 10545-4  |                              |
|   | RESISTENZA ALLA FLESSIONE IN N/mm <sup>2</sup> / N/mm <sup>2</sup> FLEXURAL STRENGTH TEST / RESISTENCIA A LA FLEXION EN N/mm <sup>2</sup> / BIEGESTÄRKE IN N/mm <sup>2</sup> / RESISTENCIA A LA FLEXION EN N/mm <sup>2</sup>  |   | 35 MIN. N/mm <sup>2</sup>   |   |  |                | valore medio<br>52 N/mm <sup>2</sup>               |          | ISO 10545-4  |                              |
|   | RESISTENZA ALL'ABRASIONE PROFONDA DELLE PIASTRELLE NON SMALTATE / RESISTANCE TO DEEP ABRASION OF UNGLAZED TILES / RESISTANCE A L'ABRASION PROFONDE DES CARREAUX NON ÉMAILLÉS / TIEFENABRIEFESTIGKEIT UNGLASIRTER FLIESEN / RESISTENCIA A LA ABRASION PROFUNDA DE LAS BALDOSAS SIN ESMALTAR.   |   | < 175 mm <sup>3</sup>   |   |  |                | valore medio<br>140 mm <sup>3</sup>                |          | ISO 10545-6  |                              |
|   | RESISTENZA AGLI SBALZI TERMICI / THERMAL SHOCKS RESISTANT / RESISTANCE AUX VARIATIONS THERMIQUES / TEMPERATURWECHSELBESTÄNDIGKEIT / RESISTENCIA AL CHOQUE TÉRMICO.  |   | Metodo di prova disponibile<br>Available testing method<br>Méthode d'essai disponible<br>Verfügbare Prüfmethode<br>Método de ensayo disponible  |   |  |                | RESISTE - RESISTANT<br>RÉSISTE - ERFÜLLT - RESISTE |          | ISO 10545-9  |                              |
|   | RESISTENZA AL GELO / FROST RESISTANCE / RESISTANCE AU GEL / FROSTSICHERHEIT / RESISTENCIA A LA HELADA   |   | RICHIESTA - REQUIRED<br>REQUISE - GEFORDERT - REQUERIDA   |   |  |                | RESISTE - RESISTANT<br>RÉSISTE - ERFÜLLT - RESISTE |          | ISO 10545-12   |                              |
|   | RESISTENZA ALLE MACCHIE / RESISTANCE TO STAINING / RESISTANCE AUX TACHES / FLECKENABWEISEND / RESISTENCIA A LAS MANCHAS.  |   | Metodo di prova disponibile<br>Available testing method<br>Méthode d'essai disponible<br>Verfügbare Prüfmethode<br>Método de ensayo disponible  |   | Classe 5   | Classe 4       | Classe 4   | Classe 4 | Classe 4-5   | ISO 10545-14                 |
|   | RILASCIO DI SOSTANZE PERICOLOSE / RELEASE OF HAZARDOUS SUBSTANCES / REJET DE SUBSTANCES DANGEREUSES / FREISETZUNG GEFAHRLICHER STOFFE / LIBERACION DE SUSTANCIAS PELIGROSAS / CADMIO (in mg/dm <sup>2</sup> ) - PIOMBO (in mg/dm <sup>2</sup> )   |   | VALORE DICHIARATO PER SUPERFICIE CON IMPIEGHI SU PAVI DI LAVORO / DECLARÉ VALLUE FOR GL SURFACES USED ON WORKTOPS / VALEUR DÉCLARÉE POUR SURFACES GL UTILISÉS SUR PLANS DE TRAVAIL / ANGEZEIGENER WERT FÜR GL-OBERFLÄCHEN ZUM GEBRAUCH ALS ARBEITSPLATZEN / VALOR DECLARADO PARA ACABADOS GL UTILIZADOS PARA SUPERFICIES DE TRABAJO   |   | CONFORME/CONFORMING<br>CONFORME/KONFORM/CONFORME |                |  |          |  | DM-1-2-2007-Reg-CE-1935-2004 |
|   | RESISTENZA A BASSE CONCENTRAZIONI DI ACIDI E ALCALI / RESISTANCE TO LOW CONCENTRATIONS OF ACIDS AND ALKALIS / RESISTANCE A BASSES CONCENTRATIONS D'ACIDES ET ALCALIS / WIDERSTAND GEGEN NIEDRIGE KONZENTRATIONEN VON SAUREN UND LAUGEN. / RESISTENCIA A BAJAS CONCENTRACIONES DE ACIDOS Y ALCALIS.  |   | COME DICHIARATO DAL PRODUTTORE<br>SEE MANUFACTURER'S DECLARATION<br>SELON DÉCLARATION DU PRODUCTEUR<br>ENTSPRECHEND DER HERSTELLERANGABEN TAL COMO DECLARA EL FABRICANTE  |   | LA-LB  | LB             | LA-LB  | LB       | LA-LB  | ISO 10545-13                 |
|   | RESISTENZA AI PRODOTTI CHIMICI DI USO DOMESTICO E AGLI ADDITIVI PER PISCINA / RESISTENCE TO DOMESTIC CHEMICAL PRODUCTS AND ADDITIVES FOR SWIMMING POOLS / RESISTANT AUX PRODUITS CHIMIQUES A USAGE DOMESTIQUE ET AUX ADDITIFS POUR PISCINE / WIDERSTAND GEGEN HAUSHALTSCHIMIKALIEN UND / SCHWIMMIBADZUSATZSTOFFEN / RESISTENCIA A PRODUCTOS PARA LIMPIEZA DOMESTICA Y ADITIVOS PARA PISCINAS  |   | B min   |   | A  |                |  |          |  |                              |
|   | COEFFICIENTE D'ATTRITO (SCIVOLosità) / FRICTION COEFFICIENT (SLIPPERINESS) / COEFFICIENT DE FRICTION (GLISSEMENT) / REIBUNGSKOEFFIZIENT (SCHLUPFRIGKEIT) / COEFFICIENTE DE ANTI DESLIZAMIENTO.  |   | -   | 6° < α ≤ 10° R9   | -  | -              | 6° < α ≤ 10° R9                                    | -        | 10° < α ≤ 19° R10  | DIN EN 16165 ANNEX B         |
|   |   |   | -   | -   | -  | -              | -  | -        | 18° ≤ α < 24° classe B   | DIN EN 16165 ANNEX A         |
|   |   |   | -   | -   | -  | -              | -  | -        | PTV>36 wet slider 96   | BS EN 16165 ANNEX C          |
|   |   |   | -   | > 0,42 wet  | -  | -              | > 0,42 wet   | -        | > 0,42 wet   | ANSI A 326.3                 |

Per un effetto ottimale della posa, florim suggerisce di mantenere 2 mm di fuga per pose monofornate e 3 mm per combinare formati misti / For optimal installation results, florim recommends maintaining a joint of 2 mm 1/16" for single format installations and 3 mm 1/8" to combine mixed formats / Pour réaliser une pose parfaite, florim suggère de maintenir 2 mm de joint pour la pose des monofornats, et 3 mm pour les combinaisons de formats mixtes / Um einen optimalen effekt beim verlegen zu erzielen empfiehlt florim eine 2 mm fugel bei einformatigen verlegungen und 3 mm fugel bei formatkombinationen / Para lograr los máximos resultados en la posa del producto, florim aconseja 2 mm de junta en aplicaciones monofornato y 3 mm en combinaciones de formatos mixtos.

| CARATTERISTICHE TECNICHE - TECHNICAL CHARACTERISTICS - CARACTERISTIQUES TECHNIQUES - TECHNISCHE EIGENSCHAFTEN - CARACTERÍSTICAS TÉCNICAS |   |  |   |  |  |   |              |
|--|---|--|---|--|--|---|--------------|
|  | LUNGHEZZA E LARGHEZZA: DEVIAZIONE AMMISSIBILE, IN %, DELLA DIMENSIONE MEDIA DI OGNI PIASTRELLA DALLA DIM. DI FABBRICAZIONE / LENGTH AND WIDTH: ADMITTED DEVIATION, IN %, OF THE AVERAGE SIZE OF EACH TILE FROM THE PRODUCTION DIMENSIONS / LONGUEUR ET LARGEUR: MARGE DE TOLÉRANCE, EN %, ENTRE LA DIMENSION MOYENNE DE CHAQUE CARREAU ET LA DIM. DE FABRICATION / LANGE UND BREITE: ZULASSIGE ABWEICHUNG DES DURCHSCHNITTMABES JEDER FLIESE VOM HERSTELLMAS IN PROZENTEN / LARGO Y ANCHO: DESVIACION ADMISIBLE, EN %, DEL TAMAÑO MEDIO DE CADA BALDOSA A PARTIR DEL TAMAÑO DE FABRICACION. | Squadrato ISO 13006  | PRESCRIZIONE STANDARD REQUIREMENTS PRESCRIPTIONS ANFORDERUNGEN PRESCRIPCION |  | RIFERIMENTO NORMA REFERENCE STANDARD RÉFÉRENCE NORME STANDARDWERT REFERENCIA NORMA |   |              |
|  |   |  | N ≥ 15 cm   |  |  |   |              |
|  |   |  | (%)   | (mm)   |  | RISULTATI TESTS TEST RESULTS RESULTATS DES ESSAIS PRÜFERGEBNIS RESULTADOS TESTS |              |
|  |   |  | INDUSTRIAL  |  |  |   |              |
|  |   |  | NATURALE MATTE  | R+PTV  | NATURALE MATTE   |   |              |
|   | DEVIAZIONE MASSIMA DI RETTILINEARITÀ, IN PERCENTO, IN RAPPORTO ALLE DIMENSIONI DI FABBRICAZIONE CORRISPONDENTI / MAXIMUM STRAIGHTNESS DEVIATION, IN %, IN RELATION TO THE CORRESPONDING PRODUCTION DIMENSIONS / MARGE DE TOLÉRANCE DE RECTITUDE, EN POURCENTAGE, PAR RAPPORT AUX DIMENSIONS DE FABRICATION CORRESPONDANTES / ZULASSIGE HÖCHSTABWEICHUNG DER KANTENGERADHEIT IM VERHÄLTNIS ZU DEN ENTSPRECHENDEN HERSTELLMÄßEN IN PROZENTEN / DESVIACION MÁXIMA DE RECTITUD, EN TANTO POR CIENTO, EN RELACION CON EL TAMAÑO DE FABRICACION CORRESPONDIENTE.                                  | Squadrato ISO 13006  | ±0,3%   | ±0,8mm   | ±0,10%   | ISO 10545-2   |              |
|  | DEVIAZIONE MASSIMA DI ORTOGONALITÀ, IN PERCENTO, IN RAPPORTO ALLE DIMENSIONI DI FABBRICAZIONE CORRISPONDENTI MAXIMUM RIGHT-ANGLE DEVIATION, IN %, IN RELATION TO THE CORRESPONDING PRODUCTION DIMENSIONS / MARGE DE TOLÉRANCE D'ANGULARITÉ, EN POURCENTAGE, PAR RAPPORT AUX DIMENSIONS DE FABRICATION / HÖCHSTABWEICHUNG DER RECHTWINKLIGKEIT IM VERHÄLTNIS ZU DEN ENTSPRECHENDEN HERSTELLMÄßEN / DESVIACION MÁXIMA DE LA ORTOGONALIDAD, EN TANTO POR CIENTO, EN RELACION CON EL TAMAÑO DE FABRICACION CORRESPONDIENTE.   | Squadrato ISO 13006  | ±0,3%   | ±1,5mm   | ±0,20%   | ISO 10545-2   |              |
|  | PLANARITÀ (CURVATURA DEL CENTRO, DELLO SPIGOLO E SVERGOLAMENTO) / FLATNESS (CURVING IN THE MIDDLE, CORNER AND WARPING) / PLANÉITÉ (COURBURE CENTRALE, DE L'ARÊTE ET GAUCHISSEMENT) / EBENFLÄCHIGKEIT (KRÜMMUNG DER MITTE, DER KANTE UND VERWINDUNG) / PLANITUD (CURVATURA DEL CENTRO, DE LA ARISTA Y ABARQUILLAMIENTO).   | Squadrato ISO 13006  | ±0,4%   | ±1,8mm   | ±0,20%   | ISO 10545-2   |              |
|  | QUALITÀ DELLA SUPERFICIE / SURFACE QUALITY / QUALITÉ DE LA SURFACE / QUALITÄT DER OBERFLÄCHE / CALIDAD DE LA SUPERFICIE.  | Il 95% min delle piastrelle deve essere esente da difetti visibili. / At least 95% of the tiles must be free from visible flaws. 95% min des carreaux ne doivent présenter aucun défaut visible. Mindestens 95% der Fliesen müssen frei von sichtbaren min. / el 95% de las baldosas tiene que estar exento de defectos visibles.        |   | CONFORME/KONFORMING CONFORME/KONFORM/CONFORME      |  | ISO 10545-2   |              |
|    | MASSA D'ACQUA ASSORBITA IN % / % WATER ABSORPTION - MASSE D'EAU ABSORBÉE EN % / WASSERAUFNAHME IN % / MASA DE AGUA ABSORBIDA EN %   |  | < 0,5%  |  | valore medio 0,08%   | ISO 10545-3   |              |
|   | FORZA DI ROTTURA IN N (sp. < 7,5 mm) - BREAKING STRENGTH IN N (thickness < 7,5 mm) / FORCE DE RUPTURE EN N (ép. < 7,5 mm) / BRUCHLAST IN N (Dicke < 7,5 mm) / FUERZA DE ROTURA EN N (gr. < 7,5 mm).   |  | ≥ 700 N   |  | valore medio 1350 N  | ISO 10545-4   |              |
|  | RESISTENZA ALLA FLESSIONE IN N/mm² / N/mm² FLEXURAL STRENGTH TEST / RESISTENCIA A LA FLEXION EN N/mm² / BIEGESTÄRKE IN N/mm² / RESISTENCIA A LA FLEXION EN N/mm²  |  | 35 MIN. N/mm²   |  | valore medio 52 N/mm²  | ISO 10545-4   |              |
|   | RESISTENZA ALL'ABRASIONE PROFONDA DELLE PIASTRELLE NON SMALTATE / RESISTANCE TO DEEP ABRASION OF UNGLAZED TILES / RESISTANCE A L'ABRASION PROFONDE DES CARREAUX NON ÉMALLÉS / TIEFENABRIEFESTIGKEIT UNGLASIRTER FLIESEN / RESISTENCIA A LA ABRASION PROFUNDA DE LAS BALDOSAS SIN ESMALTAR.  |  | < 175 mm³   |  | valore medio 140 mm³   | ISO 10545-6   |              |
|   | RESISTENZA AGLI SBALZI TERMICI / THERMAL SHOCKS RESISTANT / RÉSISTANCE AUX VARIATIONS THERMIQUES / TEMPERATURWECHSELBESTÄNDIGKEIT / RESISTENCIA AL CHOQUE TÉRMICO.  | Metodo di prova disponibile / Available testing method<br>Méthode d'essai disponible / Verfügbare Prüfmethode<br>Método de ensayo disponible   |   | RESISTE - RÉSISTANT<br>RÉSISTE - ERFÜLLT - RESISTE |  | ISO 10545-9   |              |
|   | RESISTENZA AL GELO / FROST RESISTANCE / RÉSISTANCE AU GEL / FROSTSICHERHEIT / RESISTENCIA A LA HELADA   | RICHIESTA - REQUIRED<br>REQUISIT - GEFORDERT - REQUERIDA   |   | RESISTE - RÉSISTANT<br>RÉSISTE - ERFÜLLT - RESISTE |  | ISO 10545-12  |              |
|   | RESISTENZA ALLE MACCHIE / RESISTANCE TO STAINING / RESISTANCE AUX TACHES / FLECKENABWEISUNG / RESISTENCIA A LAS MANCHAS.  | Metodo di prova disponibile / Available testing method<br>Méthode d'essai disponible / Verfügbare Prüfmethode<br>Método de ensayo disponible   |   | Classe 4   | Classe 4   | Classe 4  | ISO 10545-14 |
|   | RILASCIO DI SOSTANZE PERICOLOSE / RELEASE OF HAZARDOUS SUBSTANCES / REJET DE SUBSTANCES DANGEREUSES / FREISETZUNG GEFAHRLICHER STOFFE / LIBERACION DE SUSTANCIAS PELIGROSAS / CADMIO (in mg/dm²) - PIOMBO (in mg/dm²)   | VALORE DICHIARATO PER SUPERFICIE GL CON IMPREGHI SU PIANI DI LAVORO / DECLARED VALUE FOR GL SURFACES USED ON WORKTOPS / VALEUR DÉCLARÉE POUR SURFACES GL UTILISÉES SUR PLANS DE TRAVAIL / ANGEZEIGENER WERT FÜR GL-OBERFLÄCHEN ZUM GEBRAUCH ALS ARBEITSPLATTEN / VALOR DECLARADO PARA ACABADOS GL UTILIZADOS PARA SUPERFICIES DE TRABAJO |   | CONFORME/KONFORMING<br>CONFORME/KONFORM/CONFORME   |  | DM-1-2-2007-Reg-CE-1935-2004  |              |
|   | RESISTENZA A BASSE CONCENTRAZIONI DI ACIDI E ALCALI / RESISTANCE TO LOW CONCENTRATIONS OF ACIDS AND ALKALIS / RESISTANCE A BASSES CONCENTRATIONS D'ACIDES ET ALCALIS / WIDERSTAND GEGEN NIEDRIGE KONZENTRATIONEN VON SAUREN UND LAUGEN. / RESISTENCIA A BAJAS CONCENTRACIONES DE ACIDOS Y ALCALIS.  | COME DICHIARATO DAL PRODUTTORE<br>SEE MANUFACTURER'S DECLARATION<br>SELON DECLARATION DU PRODUCTEUR<br>ENTSPRECHEND DER HERSTELLERANGABEN TAL COMO DECLARA EL FABRICANTE   |   | LA   |  | ISO 10545-13  |              |
|  | RESISTENZA A ALTE CONCENTRAZIONI DI ACIDI ED ALCALI / RESISTANCE TO HIGH CONCENTRATIONS OF ACIDS AND ALKALIS / RESISTANCE A HAUTES CONCENTRATIONS D'ACIDES ET BASES / BESTÄNDIGKEIT GEGEN STARK KONZENTRIERTE SAURENUND LAUGEN / RESISTENCIA A ALTAS CONCENTRACIONES DE ACIDOS Y ALCALIS.   |  |   | HA   |  |   |              |
|  | RESISTENZA AI PRODOTTI CHIMICI DI USO DOMESTICO E AGLI ADDITIVI PER PISCINA / RESISTENCE TO DOMESTIC CHEMICAL PRODUCTS AND ADDITIVES FOR SWIMMING POOLS / RESISTANT AUX PRODUITS CHIMIQUES À USAGE DOMESTIQUE ET AUX ADDITIFS POUR PISCINE / WIDERSTAND GEGEN HAUSHALTSCHEMIKALIEN UND / SCHWIMMBADZUSATZSTOFFEN / RESISTENCIA A PRODUCTOS PARA LIMPIEZA DOMESTICA Y ADITIVOS PARA PISCINAS   | B min  |   | A  |  |   |              |
|   | COEFFICIENTE D'ATTRITO (SCIVOLosità) / FRICTION COEFFICIENT (SLIPPERINESS) / COEFFICIENT DE FRICTION (GLISSEMENT) / REIBUNGSKOEFFIZIENT (SCHLUPFRIGKEIT) / COEFICIENTE DE ANTI DESLIZAMIENTO.   |  |   | > 0,42 wet   |  | ANSI A 326.3  |              |
|  |   |  |   | 18° ≤ α < 24°<br>classe B                          | 12° ≤ α < 18°<br>classe A  | DIN EN 16165<br>ANNEX A   |              |
|  |   |  |   | 6° < α ≤ 10°<br>R9                                 | 6° < α ≤ 10°<br>R9   | DIN EN 16165<br>ANNEX B   |              |
|  |   |  |   | PTV > 36<br>wet<br>slider 96                       | -  | BS EN 16165<br>ANNEX C  |              |

Per un effetto ottimale della posa, florim suggerisce di mantenere 2 mm di fuga per pose monoformato e 3 mm per combinare formati misti / For optimal installation results, florim recommends maintaining a joint of 2 mm 1/12" for single format installations and 3 mm 1/8" to combine mixed formats / Pour réaliser une pose parfaite, florim suggère de maintenir 2 mm de joint pour la pose des monoformats, et 3 mm pour les combinaisons de formats mixtes / Um einen optimalen effekt beim verlegen zu erzielen empfiehlt florim eine 2 mm fugje bei einformatigen verlegungen und 3 mm fugje bei formatkombinationen / Para lograr los máximos resultados en la posa del producto, florim aconseja 2 mm de junta en aplicaciones monoformato y 3 mm en combinaciones de formatos mixtos.



| CARATTERISTICHE TECNICHE - TECHNICAL CHARACTERISTICS - CARACTERISTIQUES TECHNIQUES - TECHNISCHE EIGENSCHAFTEN - CARACTERÍSTICAS TÉCNICAS |   |  |   |   |  |                              |
|--|---|--|---|---|--|------------------------------|
|  | Lastre in gres fine porcellanato non smaltato. Piastrelle di ceramica pressate a secco. Caratteristiche di qualità secondo i test di controllo previsti dalla norma EN 14411-ISO 13006 Appendice G gruppo Bia UGL/ Unglazed porcelain stoneware slabs. Dry-pressed ceramic tiles. Quality specifications, according to control tests of EN 14411-ISO 13006 Appendix G group Bia UGL. / Dalles en gres cérame fin non émaillé. Carreaux céramiques pressés à sec. Caractéristiques de qualité d'après les essais de contrôle norme EN 14411-ISO 13006 Appendice G groupe Bia UGL/ Nicht glasierte und vollständig gesinterte Feinsteinzeugplatten. Trocken gepresste Keramikfliesen. Qualitätseigenschaften nach Normen EN 14411-ISO 13006 Anhang G Gruppe Bia UGL/ Planchas de gres porcelánico fino no esmaltado. Baldosas de cerámica prensadas en seco. Características de calidad según las Normas EN 14411-ISO 13006 Apéndice G grupo Bia UGL. | PRESCRIZIONE STANDARD REQUIREMENTS PRESCRIPTIONS ANFORDERUNGEN PRESCRIPCION  |   | RISULTATI TESTS TEST RESULTS RESULTATS DES ESSAIS PRÜFERGEBNIS RESULTADOS TESTS | RIFERIMENTO NORMA REFERENCE STANDARD RÉFERENCE NORME STANDARDWERT REFERENCIA NORMA |                              |
|  |   | N ≥ 15 cm  |   |   |  | COMFORT                      |
|  |   | (%)  | (mm)  |   |  |                              |
|  | LUNGHEZZA E LARGHEZZA: DEVIAZIONE AMMISSIBILE, IN %, DELLA DIMENSIONE MEDIA DI OGNI PIASTRELLA DALLA DIM. DI FABBRICAZIONE / LENGTH AND WIDTH: ADMITTED DEVIATION, IN %, OF THE AVERAGE SIZE OF EACH TILE FROM THE PRODUCTION DIMENSIONS / LONGUEUR ET LARGEUR: MARGE DE TOLÉRANCE, EN %, ENTRE LA DIMENSION MOYENNE DE CHAQUE CARREAU ET LA DIM. DE FABRICATION / LÄNGE UND BREITE: ZULASSIGE ABWEICHUNG DES DURCHSCHNITTMABES JEDER FLIESE VOM HERSTELLMAß IN PROZENTEN / LARGO Y ANCHO: DESVIACION ADMISIBLE, EN %, DEL TAMAÑO MEDIO DE CADA BALDOSA A PARTIR DEL TAMAÑO DE FABRICACIÓN.   | Squadrato ISO 13006  | ±0,3%   | ±1,0 mm   | ±0,15%   |                              |
|  | DEVIAZIONE AMMISSIBILE, IN PERCENTO, DELLO SPESORE MEDIO DI OGNI PIASTRELLA DALLA DIMENSIONE DI FABBRICAZIONE / ADMITTED DEVIATION, IN %, OF THE AVERAGE THICKNESS OF EACH TILE FROM THE PRODUCTION DIMENSIONS / MARGE DE TOLÉRANCE, EN POURCENTAGE, ENTRE L'ÉPAISSEUR MOYENNE DE CHAQUE CARREAU ET LA DIMENSION DE FABRICATION / ZULASSIGE ABWEICHUNG DER DURCHSCHNITTSDICKE JEDER FLIESE VOM HERSTELLMAß IN PROZENTEN / DESVIACION ADMISIBLE, EN TANTO POR CIENTO, DEL GROSOR MEDIO DE CADA BALDOSA A PARTIR DEL TAMAÑO DE FABRICACIÓN.   | Squadrato ISO 13006  | ±5%   | ±0,5 mm   | ±5%  |                              |
|  | DEVIAZIONE MASSIMA DI RETTILINEARITÀ, IN PERCENTO, IN RAPPORTO ALLE DIMENSIONI DI FABBRICAZIONE CORRISPONDENTI / MAXIMUM RIGHT-ANGLE DEVIATION, IN %, IN RELATION TO THE CORRESPONDING PRODUCTION DIMENSIONS / MARGE DE TOLÉRANCE DE RECTITUDE, EN POURCENTAGE, PAR RAPPORT AUX DIMENSIONS DE FABRICATION CORRÉSPONDANTES / ZULASSIGE HÖCHSTABWEICHUNG DER KANTENGERADHEIT IM VERHÄLTNIß ZU DEN ENTSPRECHENDEN HERSTELLMAßEN IN PROZENTEN / DESVIACIÓN MÁXIMA DE RECTITUD, EN TANTO POR CIENTO, EN RELACIÓN CON EL TAMAÑO DE FABRICACIÓN CORRESPONDIENTE.   | Squadrato ISO 13006  | ±0,3%   | ±0,8 mm   | ±0,10%   | ISO 10545-2                  |
|  | DEVIAZIONE MASSIMA DI ORTOGONALITÀ, IN PERCENTO, IN RAPPORTO ALLE DIMENSIONI DI FABBRICAZIONE CORRISPONDENTI / MAXIMUM STRAIGHTNESS DEVIATION, IN %, IN RELATION TO THE CORRESPONDING PRODUCTION DIMENSIONS / MARGE DE TOLÉRANCE D'ANGULARITÉ, EN POURCENTAGE, PAR RAPPORT AUX DIMENSIONS DE FABRICATION CORRÉSPONDANTES / ZULASSIGE HÖCHSTABWEICHUNG DER ENTSPRECHENDEN HERSTELLMAßEN IN PROZENTEN / DESVIACIÓN MÁXIMA DE LA ORTOGONALIDAD, EN TANTO POR CIENTO, EN RELACIÓN CON EL TAMAÑO DE FABRICACIÓN CORRESPONDIENTE.   | Squadrato ISO 13006  | ±0,3%   | ±1,5 mm   | ±0,20%   |                              |
|  | PLANARITÀ (CURVATURA DEL CENTRO, DELLO SPIGOLO E SVERGOLAMENTO) / FLATNESS (CURVING IN THE MIDDLE, CORNER AND WARPING) / PLANEITÉ (COURBURE CENTRALE, DE L'ARETE ET GAUCHISSEMENT) / EBENFLÄCHIGKEIT (KRÜMMUNG DER MITTE, DER KANTE UND VERWINDUNG) / PLANITUD (CURVATURA DEL CENTRO, DE LA ARISTA Y ABRUQUILLAMIENTO).   | Squadrato ISO 13006  | ±0,4%   | ±1,8 mm   | ±0,20%   |                              |
|  | QUALITÀ DELLA SUPERFICIE - SURFACE QUALITY / QUALITÉ DE LA SURFACE<br>QUALITÄT DER OBERFLÄCHE / CALIDAD DE LA SUPERFICIE.   | Il 95% min delle piastrelle deve essere esente da difetti visibili.<br>/ At least 95% of the tiles must be free from visible flaws. 95% min des carreaux ne doivent présenter aucun défaut visible.<br>Mindestens 95% der Fliesen müssen frei von sichtbaren min.<br>/ el 95% de las baldosas tiene que estar exento de defectos visibles. |   | CONFORME/CONFORMING<br>CONFORME/KONFORM/CONFORME                                |  |                              |
|  | MASSA D'ACQUA ASSORBITA IN % / % WATER ABSORPTION - MASSE D'EAU ABSORBÉE EN %<br>WASSERAUFNAHME IN % / MASA DE AGUA ABSORBIDA EN %  |  | E≤0,5%  |   | valore medio 0,08%   | ISO 10545-3                  |
|  | FORZA DI ROTTURA IN N (sp. < 7,5 mm) - BREAKING STRENGTH IN N (thickness < 7,5 mm) / FORCE DE RUPTURE EN N (ép. < 7,5 mm) / BRUCHLAST IN N (Dicke < 7,5 mm) / FUERZA DE ROTURA EN N (gr. < 7,5 mm).   |  | ≥ 700 N   |   | valore medio 1350 N  | ISO 10545-4                  |
|  | RESISTENZA ALLA FLESSIONE IN N/mm² / N/mm² FLEXURAL STRENGTH TEST / RÉSISTANCE A LA FLEXION EN N/mm² / BIEGEFESTIGKEIT IN N/mm² / RESISTENCIA A LA FLEXIÓN EN N/mm²   |  | 35 MIN. N/mm²   |   | valore medio 52 N/mm²  | ISO 10545-6                  |
|  | RESISTENZA ALL'ABRASIONE PROFONDA DELLE PIASTRELLE NON SMALTATE / RESISTANCE TO DEEP ABRASION OF UNGLAZED TILES / RESISTANCE A L'ABRASION PROFONDE DES CARREAUX NON ÉMAILLÉS / TIEFENABRIEBFESTIGKEIT UNGLASIERTER FLIESEN / RESISTENCIA A LA ABRASION PROFUNDA DE LAS BALDOSAS SIN ESMALTAR  |  | <175mm³   |   | valore medio 140mm³  | ISO 10545-6                  |
|  | RESISTENZA AGLI SBALZI TERMICI/THERMAL SHOCKS RESISTANT/RÉSISTANCE AUX VARIATIONS THERMIQUES<br>TEMPÉRATURWECHSELBESTÄNDIGKEIT / RESISTENCIA AL CHOQUE TÉRMICO.   |  | -   |   | RESISTE - RÉSISTANT<br>RÉSISTE - ERFÜLLT - RESISTE                                 | ISO 10545-9                  |
|  | RESISTENZA AL GELO / FROST RESISTANCE - RÉSISTANCE AU GEL / FROSTSICHERHEIT<br>RESISTENCIA A LA HELADA  |  | RICHIESTA - REQUIRED<br>REQUIRE - GEFORDERT - REQUERIDA   |   | RESISTE - RÉSISTANT<br>RÉSISTE - ERFÜLLT - RESISTE                                 | ISO 10545-12                 |
|  | RESISTENZA ALLE MACCHIE / RESISTANCE TO STAINING / RÉSISTANCE AUX TACHES<br>FLECKENABWEISEND / RESISTENCIA A LAS MANCHAS.   |  | RICHIESTA - REQUIRED<br>REQUIRE - GEFORDERT - REQUERIDA   |   | Classe 4-5   | ISO 10545-14                 |
|  | RILASCIO DI SOSTANZE PERICOLOSE / RELEASE OF HAZARDOUS SUBSTANCES / REJET DE SUBSTANCES DANGEREUSES / FREISETZUNG GEFAHRLICHER STOFFE / LIBERACIÓN DE SUSTANCIAS PELIGROSAS / CADMIO (in mg/dm²) - PIOMBO (in mg/dm²)   |  | METODO DI PROVA DISPONIBILE<br>AVAILABLE TESTING METHOD<br>METHODE D'ESSAI DISPONIBLE<br>VERFÜGBARE PRÜFMETHODE<br>MÉTODO DE ENSAYO DISPONIBLE                              |   | CONFORME/CONFORMING<br>CONFORME/KONFORM/CONFORME                                   | DM-1-2-2007-Reg-CE-1935-2004 |
|  | RESISTENZA A BASSE CONCENTRAZIONI DI ACIDI E ALCALI. / RESISTANCE TO LOW CONCENTRATIONS OF ACIDS AND ALKALIS. / RESISTANCE A BASSES CONCENTRATIONS D'ACIDES ET ALCALIS. / WIDERSTAND GEGEN NIEDRIGE KONZENTRATIONEN VON SÄUREN UND LAUGEN. / RESISTENCIA A BAJAS CONCENTRACIONES DE ÁCIDOS Y ALCALIS.   |  | COME DICHIARATO DAL PRODUTTORE<br>SEE MANUFACTURER'S DECLARATION<br>SELON DÉCLARATION DU PRODUCTEUR<br>ENTSPRECHEND DER HERSTELLERANGABEN<br>TAL COMO DECLARA EL FABRICANTE |   | LA   | ISO 10545-13                 |
|  | RESISTENZA AI PRODOTTI CHIMICI DI USO DOMESTICO E AGLI ADDITIVI PER PISCINA / RESISTENCE TO DOMESTIC CHEMICAL PRODUCTS AND ADDITIVES FOR SWIMMING POOLS / RÉSISTANT AUX PRODUITS CHIMIQUES À USAGE DOMESTIQUE ET AUX ADDITIFS POUR PISCINE / WIDERSTAND GEGEN HAUSHALTSCHENMIKALIEN UND SCHWIMMBADZUSATZSTOFFEN / RESISTENCIA A PRODUCTOS PARA LIMPIEZA DOMÉSTICA Y ADITIVOS PARA PISCINAS  |  | B min   |   | A  |                              |
|  | COEFFICIENTE D'ATTRITO (SCIVOLOSITÀ)/FRICTION COEFFICIENT (SLIPPERINESS)/COEFFICIENT DE FRICTION (GLISSEMENT) / REIBUNGSKOEFFIZIENT (SCHLUPFRIGKEIT) - COEFICIENTE DE ANTI DESLIZAMIENTO  |  |   |   | 10° < α ≤ 19°<br>R10   | DIN EN 16165<br>ANNEX B      |
|  |   |  |   |   | 18° ≤ α < 24°<br>classe B  | DIN EN 16165<br>ANNEX A      |
|  |   |  |   |   | PTV > 36 wet<br>slider 96  | BS EN 16165<br>ANNEX C       |
|  |   |  |   |   | > 0,42 wet   | ANSI A 326.3                 |

Per un effetto ottimale della posa, florim suggerisce di mantenere 2 mm di fuga per pose monoformato e 3 mm per combinare formati misti / For optimal installation results, florim recommends maintaining a joint of 2 mm 1/12" for single format installations and 3 mm 1/8" to combine mixed formats / Pour réaliser une pose parfaite, florim suggère de maintenir 2 mm de joint pour la pose des monoformats, et 3 mm pour les combinaisons de formats mixtes / Um einen optimalen effekt beim verlegen zu erzielen empfiehlt florim eine 2 mm fuge bei einformatigen verlegungen und 3 mm fuge bei formatkombinationen / Para lograr los máximos resultados en la posa del producto, florim aconseja 2 mm de junta en aplicaciones monoformato y 3 mm en combinaciones de formatos mixtos.

| CARATTERISTICHE TECNICHE - TECHNICAL CHARACTERISTICS - CARACTERISTIQUES TECHNIQUES - TECHNISCHE EIGENSCHAFTEN - CARACTERÍSTICAS TÉCNICAS |   |   |               |   |   |  |                              |
|--|---|---|---------------|---|---|--|------------------------------|
|  | Lastre in gres fine porcellanato non smaltato. Piastrelle di ceramica pressate a secco. Caratteristiche di qualità secondo i test di controllo previsti dalla norma EN 14411-ISO 13006 Appendice G gruppo Bla UGL. / Unglazed porcelain stoneware slabs. Dry-pressed ceramic tiles. Quality specifications, according to control tests of EN 14411-ISO 13006 Appendix G group Bla UGL. / Dalles en grès cérame fin non émaillé. Carreaux céramiques pressés à sec. Caractéristiques de qualité d'après les essais de contrôle norme EN 14411-ISO 13006 Appendice G groupe B1a UGL. / Nicht glasierte und vollständig gesinterte Feinsteinzeugplatten. Trocken gepresste Keramikfliesen. Qualitätsigenschaften nach Normen EN 14411-ISO 13006 Anhang G Gruppe Bla UGL. / Planchas de gres porcelánico fino no esmaltado. Baldosas de cerámica resandadas en seco. Características de calidad según las Normas EN 14411-ISO 13006 Apéndice G grupo Bla UGL. | PRESCRIZIONE STANDARD REQUIREMENTS PRESCRIPTIONS ANFORDERUNGEN PRESCRIPTION |               | RISULTATI TESTS TEST RESULTS RESULTATS DES ESSAIS PRÜFERGEBNIS RESULTADOS TESTS | RIFERIMENTO NORMA REFERENCE STANDARD STANDARDWERT REFERENCIA NORMA  |  |                              |
|  |   | N ≥ 15 cm   |               |   |   |  |                              |
|  |   | (%)   | (mm)          |   |   | MATTE  |                              |
|  | LUNGHEZZA E LARGHEZZA: DEVIAZIONE AMMISSIBILE, IN %, DELLA DIMENSIONE MEDIA DI OGNI PIASTRELLA DALLA DIM. DI FABBRICAZIONE / LENGTH AND WIDTH: ADMITTED DEVIATION, IN %, OF THE AVERAGE SIZE OF EACH TILE FROM THE PRODUCTION DIMENSIONS / LONGUEUR ET LARGEUR : MARGE DE TOLÉRANCE, EN %, ENTRE LA DIMENSION MOYENNE DE CHAQUE CARREAU ET LA DIM. DE FABRICATION / LANGE UND BREITE: ZULÄSSIGE ABWEICHUNG DES DURCHSCHNITTMÄßES JEDER FLESE VOM HERSTELLMAß IN PROZENTEN / LARGO Y ANCHO: DESVIACION ADMISIBLE, EN %, DEL TAMAÑO MEDIO DE CADA BALDOSA A PARTIR DEL TAMAÑO DE FABRICACIÓN.   | Squadrato ISO 13006   | ±0,3 %        | ±1,0 mm   | ±0,15 %   | ISO 10545-2  |                              |
|  | DEVIAZIONE AMMISSIBILE, IN PERCENTO, DELLO SPESORE MEDIO DI OGNI PIASTRELLA DALLA DIMENSIONE DI FABBRICAZIONE / ADMITTED DEVIATION, IN %, OF THE AVERAGE THICKNESS OF EACH TILE FROM THE PRODUCTION DIMENSIONS / MARGE DE TOLÉRANCE, EN POURCENTAGE, ENTRE L'ÉPAISSEUR MOYENNE DE CHAQUE CARREAU ET LA DIMENSION DE FABRICATION / ZULÄSSIGE ABWEICHUNG DER DURCHSCHNITTSDICKE MITTER FLESE VOM HERSTELLMAß IN PROZENTEN / DESVIACION ADMISIBLE, EN TANTO POR CIENTO, DEL GROSOR MEDIO DE CADA BALDOSA A PARTIR DEL TAMAÑO DE FABRICACIÓN.   | Squadrato ISO 13006   | ±5 %          | ±0,5 mm   | ±5 %  | ISO 10545-2  |                              |
|  | DEVIAZIONE MASSIMA DI RETTILINEARITÀ IN PERCENTO, IN RAPPORTO ALLE DIMENSIONI DI FABBRICAZIONE CORRISPONDENTI / MAXIMUM STRAIGHTNESS DEVIATION, IN %, IN RELATION TO THE CORRESPONDING PRODUCTION DIMENSIONS / MARGE DE TOLÉRANCE DE RECTITUDE, EN POURCENTAGE, PAR RAPPORT AUX DIMENSIONS DE FABRICATION / HOCHSTABWEICHUNG DER KANTENGERÄDHEIT IM VERHÄLTNIß ZU DEN ENTSPRECHENDEN HERSTELLMAßEN IN PROZENTEN / DESVIACIÓN MÁXIMA DE RECTITUD, EN TANTO POR CIENTO, EN RELACIÓN CON EL TAMAÑO DE FABRICACIÓN CORRESPONDIENTE.   | Squadrato ISO 13006   | ±0,3 %        | ±0,8 mm   | ±0,10 %   | ISO 10545-2  |                              |
|  | DEVIAZIONE MASSIMA DI ORTOGONALITÀ IN PERCENTO, IN RAPPORTO ALLE DIMENSIONI DI FABBRICAZIONE CORRISPONDENTI MAXIMUM RIGHT-ANGLE DEVIATION, IN %, IN RELATION TO THE CORRESPONDING PRODUCTION DIMENSIONS / MARGE DE TOLÉRANCE D'ANGULARITÉ, EN POURCENTAGE, PAR RAPPORT AUX DIMENSIONS DE FABRICATION / HOCHSTABWEICHUNG DER RECHTWINKELIGKEIT IM VERHÄLTNIß ZU DEN ENTSPRECHENDEN HERSTELLMAßEN IN PROZENTEN / DESVIACIÓN MÁXIMA DE LA ORTOGONALIDAD, EN TANTO POR CIENTO, EN RELACIÓN CON EL TAMAÑO DE FABRICACIÓN CORRESPONDIENTE.  | Squadrato ISO 13006   | ±0,3 %        | ±1,5 mm   | ±0,20 %   | ISO 10545-2  |                              |
|  | PLANARITÀ (CURVATURA DEL CENTRO, DELLO SPIGOLO E SVERGOLAMENTO) / PLANÉITE (COURBURE CENTRALE, DE L'ARÊTE ET GAUCHISSEMENT) / EBENFLÄCHIGKEIT (KRÜMMUNG DER MITTE, DER KANTE UND WINDUNG) / PLANITUD (CURVATURA DEL CENTRO, DE LA ARISTA Y ABARQUILLAMIENTO).   | Squadrato ISO 13006   | ±0,4 %        | ±1,8 mm   | ±0,20 %   | ISO 10545-2  |                              |
|  | QUALITÀ DELLA SUPERFICIE / SURFACE QUALITY / QUALITÉ DE LA SURFACE / QUALITÄT DER OBERFLÄCHE / CALIDAD DE LA SUPERFICIE   |   |               |   | Il 95% min delle piastrelle deve essere esente da difetti visibili. / At least 95% of the tiles must be free from visible flaws. / 95% min des carreaux ne doivent présenter aucun défaut visible. Mindestens 95% der Fliesen müssen frei von sichtbaren min. / el 95% de las baldosas tiene que estar exento de defectos visibles.   | CONFORME/CONFORMING CONFORME/KONFORM/CONFORME      | ISO 10545-2                  |
|  | MASSA D'ACQUA ASSORBITA IN % / % WATER ABSORPTION - MASSE D'EAU ABSORBÉE EN % / WASSERAUFNAHME IN % / MASA DE AGUA ABSORBIDA EN %   |   | < 0,5 %       |   | valore medio 0,08 %   | ISO 10545-3  |                              |
|  | FORZA DI ROTTURA IN N (sp. < 7,5 mm) - BREAKING STRENGTH IN N (thickness < 7,5 mm) / FORCE DE RUPTURE EN N (ép. < 7,5 mm) / BRUCHLAST IN N (Dicke < 7,5 mm) / FUERZA DE ROTURA EN N (gr. < 7,5 mm).   |   | ≥ 700 N       |   | valore medio 1350 N   | ISO 10545-4  |                              |
|  | RESISTENZA ALLA FLESSIONE IN N/mm² / N/mm² FLEXURAL STRENGTH TEST / RÉSISTANCE A LA FLEXION EN N/mm² / BIEGEFESTIGKEIT IN N/mm² / RESISTENCIA A LA FLEXIÓN EN N/mm²   |   | 35 MIN. N/mm² |   | valore medio 52 N/mm²   | ISO 10545-4  |                              |
|  | RESISTENZA ALL'ABRASIONE PROFONDA DELLE PIASTRELLE NON SMALTATE / RESISTANCE TO DEEP ABRASION OF UNGLAZED TILES / RÉSISTANCE A L'ABRASION PROFONDE DES CARREAUX NON ÉMAILLÉS / TIEFENABRIEBFESTIGKEIT UNGLASIERTER FLESEN / RESISTENCIA A LA ABRASION PROFUNDA DE LAS BALDOSAS SIN ESMALTAR.  |   | < 175 mm³     |   | valore medio 140 mm³  | ISO 10545-6  |                              |
|  | RESISTENZA AGLI SBALZI TERMICI / THERMAL SHOCKS RESISTANT / RÉSISTANCE AUX VARIATIONS THERMIQUES / TEMPERATURWECHSELBESTÄNDIGKEIT / RESISTENCIA AL CHOQUE TÉRMICO.  |   |               |   | Metodo di prova disponibile / Available testing method<br>Méthode d'essai disponible / Verfügbare Prüfmethode<br>Metodo de ensayo disponible  | RESISTE - RÉSISTANT<br>RESISTE - ERFÜLLT - RESISTE | ISO 10545-9                  |
|  | RESISTENZA AL GELO / FROST RESISTANCE / RÉSISTANCE AU GEL / FROSTSICHERHEIT<br>RESISTENCIA A LA HELADA  |   |               |   | RICHIESTA - REQUIRED<br>REQUIRE - GEFORDERT - REQUERIDA   | RESISTE - RÉSISTANT<br>RESISTE - ERFÜLLT - RESISTE | ISO 10545-12                 |
|  | RESISTENZA ALLE MACCHIE / RESISTANCE TO STAINING / RÉSISTANCE AUX TACHES / FLECKENABWEISEND / RESISTENCIA A LAS MANCHAS.  |   |               |   | Metodo di prova disponibile / Available testing method<br>Méthode d'essai disponible / Verfügbare Prüfmethode<br>Metodo de ensayo disponible  | Classe 4-5   | ISO 10545-14                 |
|  | RLASCIO DI SOSTANZE PERICOLOSE / RELEASE OF HAZARDOUS SUBSTANCES / REJET DE SUBSTANCES DANGEREUSES / FREISETZUNG GEFAHRLICHER STOFFE / LIBERACIÓN DE SUSTANCIAS PELIGROSAS / CADMIO (in mg/dm²) - PIOMBO (in mg/dm²)  |   |               |   | VALORE DICHIARATO PER SUPERFICIE GL CON IMPIEGH SU PIANI DI LAVORO / DECLARED VALUE FOR GL SURFACES USED ON WORKTOPS / VALEUR DÉCLARÉE POUR SURFACES GL UTILISÉES SUR PLANS DE TRAVAIL / ANGEGBENER WERT FÜR GL OBERFLÄCHEN ZUM GEBRAUCH ALS ARBEITSPLATTEN / VALOR DECLARADO PARA ACABADOS GL UTILIZADOS PARA SUPERFICIES DE TRABAJO | CONFORME/CONFORMING<br>CONFORME/KONFORM/CONFORME   | DM-1-2-2007-Reg-CE-1935-2004 |
|  | RESISTENZA A BASSE CONCENTRAZIONI DI ACIDI E ALCALI. / RESISTANCE TO LOW CONCENTRATIONS OF ACIDS AND ALKALIS. / RESISTENCIA A BASSAS CONCENTRACIONES D'ACIDES ET ALCALIS. / WIDERSTAND GEGEN NIEDRIGE KONZENTRATIONEN VON SAUREN UND LAUGEN. / RESISTENCIA A BAJAS CONCENTRACIONES DE ACIDOS Y ALCALIS.   |   |               |   | COME DICHIARATO DAL PRODUTTORE<br>SEE MANUFACTURER'S DECLARATION<br>SELON DÉCLARATION DU PRODUCTEUR<br>ENTSPRECHEND DER HERSTELLERANGABEN TAL COMO DECLARA EL FABRICANTE  | LA   | ISO 10545-13                 |
|  | RESISTENZA AI PRODOTTI CHIMICI DI USO DOMESTICO E AGLI ADDITIVI PER PISCINA / RESISTENCE TO DOMESTIC CHEMICAL PRODUCTS AND ADDITIVES FOR SWIMMING POOLS / RÉSISTANT AUX PRODUITS CHIMIQUES À USAGE DOMESTIQUE ET AUX ADDITIFS POUR PISCINE / WIDERSTAND GEGEN HAUSHALTSCHEMİKALIEN UND / SCHWIMMBADZUSATZSTOFFEN / RESISTENCIA A PRODUCTOS PARA LIMPIEZA DOMESTICA Y ADITIVOS PARA PISCINAS   |   | B min         |   | A   |  |                              |
|  |   |   | -             |   | 10° < α < 19°<br>R10  |  | DIN EN 16165 ANNEX B         |
|  | COEFFICIENTE D'ATTRITO (SCIVOLosità) / FRICTION COEFFICIENT (SLIPPERINESS) / COEFFICIENT DE FRICTION (GLISSEMENT) / REIBUNGSKOEFFIZIENT (SCHLUPFRIGKEIT) / COEFFICIENTE DE ANTI DESLIZAMIENTO.  |   | -             |   | 18° ≤ α < 24°<br>classe B   |  | DIN EN 16165 ANNEX A         |
|  |   |   | -             |   | > 0,42 wet  |  | ANSI A 326.3                 |
|  |   |   | -             |   | PTV >36 wet slider 96   |  | BS EN 16165 ANNEX C          |

Per un effetto ottimale della posa, florim suggerisce di mantenere 2 mm di fuga per pose monofornato e 3 mm per combinare formati misti / For optimal installation results, florim recommends maintaining a joint of 2 mm 1/16" for single format installations and 3 mm 1/8" to combine mixed formats / Pour réaliser une pose parfaite, florim suggère de maintenir 2 mm de joint pour la pose des monofornats, et 3 mm pour les combinaisons de formats mixtes / Um einen optimalen effekt beim verlegen zu erzielen empfiehlt florim eine 2 mm fugje bei einformatigen verlegungen und 3 mm fugje bei formatkombinationen / Para lograr los máximos resultados en la posa del producto, florim aconseja 2 mm de junta en aplicaciones monofornato y 3 mm en combinaciones de formatos mixtos.

CARATTERISTICHE TECNICHE - TECHNICAL CHARACTERISTICS - CARACTERÍSTICAS TÉCNICAS - TECHNISCHE EIGENSCHAFTEN - CARACTERÍSTICAS TÉCNICAS











| Lastre in gres fine porcellanato non smaltato. Piastrelle di ceramica pressate a secco. Caratteristiche di qualità secondo i test di controllo previsti dalla norma EN 14411-ISO 13006 Appendice G gruppo Bia UGL. / Unglazed porcelain stoneware slabs. Dry-pressed ceramic tiles. Quality specifications, according to control tests of EN 14411-ISO 13006 Appendix G group Bia UGL. / Dalles en grés cérame fin non émaillé. Carreaux céramiques pressés à sec. Caractéristiques de qualité d'après les essais de contrôle norme EN 14411-ISO 13006 Appendice G groupe B1a UGL. / Nicht glasierte und vollständig gesinterte Feinsteinzeugplatten. Trocken gepresste Keramikfliesen. Qualitätseigenschaften nach Normen EN 14411-ISO 13006 Anhang G Gruppe Bia UGL. / Planchas de gres porcelánico fino no esmaltado. Baldosas de cerámica remasadas en seco. Características de calidad según las Normas EN 14411-ISO 13006 Apéndice G grupo Bia UGL. |   | PRESCRIZIONE STANDARD REQUIREMENTS PRESCRIPTIONS ANFORDERUNGEN PRESCRIPCION   |                                   | RISULTATI TESTS TEST RESULTS RESULTATS DES ESSAIS PRÜFERGEBNIS RESULTADOS TESTS |                              | RIFERIMENTO NORMA REFERENCE STANDARD STANDARDWERT REFERENCIA NORMA |
|---|---|---|-----------------------------------|---|------------------------------|--|
|   |   | N ≥ 15 cm   |                                   | SOFT  | MATTE                        |  |
|   |   | (%)   | (mm)                              |   |                              |  |
|   | LUNGHEZZA E LARGHEZZA: DEVIAZIONE AMMISSIBILE, IN %, DELLA DIMENSIONE MEDIA DI OGNI PIASTRELLA DALLA DIM. DI FABBRICAZIONE / LENGTH AND WIDTH: ADMITTED DEVIATION, IN % OF THE AVERAGE SIZE OF EACH TILE FROM THE PRODUCTION DIMENSIONS / LONGUEUR ET LARGEUR : MARGE DE TOLÉRANCE, EN %, ENTRE LA DIMENSION MOYENNE DE CHAQUE CARREAU ET LA DIM. DE FABRICATION / LANGE UND BREITE: ZULÄSSIGE ABWEICHUNG DES DURCHSCHNITTMÄßES JEDER FLIESE VOM HERSTELLMAß IN PROZENTEN / LARGO Y ANCHO: DESVIACION ADMISIBLE, EN %, DEL TAMAÑO MEDIO DE CADA BALDOSA A PARTIR DEL TAMAÑO DE FABRICACION. | Squadrato ISO 13006   | ±0,3 %                            | ±1,0 mm   | ±0,15 %                      | ISO 10545-2  |
|   | DEVIAZIONE AMMISSIBILE, IN PERCENTO, DELLO SPESSORE MEDIO DI OGNI PIASTRELLA DALLA DIMENSIONE DI FABBRICAZIONE / ADMITTED DEVIATION, IN % OF THE AVERAGE THICKNESS OF EACH TILE FROM THE PRODUCTION DIMENSIONS / MARGE DE TOLÉRANCE, EN POURCENTAGE, ENTRE L'ÉPAISSEUR MOYENNE DE CHAQUE CARREAU ET LA DIMENSION DE FABRICATION / ZULÄSSIGE ABWEICHUNG DER DURCHSCHNITTSDICKE JEDER FLIESE VOM HERSTELLMAß IN PROZENTEN / DESVIACION ADMISIBLE, EN TANTO POR CIENTO, DEL GROSOR MEDIO DE CADA BALDOSA A PARTIR DEL TAMAÑO DE FABRICACION.   | Squadrato ISO 13006   | ±5 %                              | ±0,5 mm   | ±5 %                         | ISO 10545-2  |
|   | DEVIAZIONE MASSIMA DI RETTILINEARITÀ, IN PERCENTO, IN RAPPORTO ALLE DIMENSIONI DI FABBRICAZIONE CORRISPONDENTI / MAXIMUM STRAIGHTNESS DEVIATION, IN %, IN RELATION TO THE CORRESPONDING PRODUCTION DIMENSIONS / MARGE DE TOLÉRANCE DE RECTITUDE, EN POURCENTAGE, PAR RAPPORT AUX DIMENSIONS DE FABRICATION CORRÉPONDANTES / ZULÄSSIGE HÖCHSTABWEICHUNG DER KANTENGERADHEIT IM VERHÄLTNIß ZU DEN ENTSPRECHENDEN HERSTELLMAßEN IN PROZENTEN / DESVIACION MÁXIMA DE RECTITUD, EN TANTO POR CIENTO, EN RELACION CON EL TAMAÑO DE FABRICACION CORRESPONDIENTE.                                   | Squadrato ISO 13006   | ±0,3 %                            | ±0,8 mm   | ±0,10 %                      | ISO 10545-2  |
|   | DEVIAZIONE MASSIMA DI ORTOGONALITÀ, IN PERCENTO, IN RAPPORTO ALLE DIMENSIONI DI FABBRICAZIONE CORRISPONDENTI / MAXIMUM RIGHT-ANGLE DEVIATION, IN %, IN RELATION TO THE CORRESPONDING PRODUCTION DIMENSIONS / MARGE DE TOLÉRANCE D'ANGULARITÉ, EN POURCENTAGE, PAR RAPPORT AUX DIMENSIONS DE FABRICATION / HÖCHSTABWEICHUNG DER RECHTWINKLIGKEIT IM VERHÄLTNIß ZU DEN ENTSPRECHENDEN HERSTELLMAßEN IN PROZENTEN / DESVIACION MÁXIMA DE LA ORTOGONALIDAD, EN TANTO POR CIENTO, EN RELACION CON EL TAMAÑO DE FABRICACION CORRESPONDIENTE.  | Squadrato ISO 13006   | ±0,3 %                            | ±1,5 mm   | ±0,20 %                      | ISO 10545-2  |
|   | PLANARITÀ (CURVATURA DEL CENTRO, DELLO SPIGOLO E SVERGOLAMENTO) / FLATNESS (CURVING IN THE MIDDLE, CORNER AND WARPING) / PLANEITÉ (COURBURE CENTRALE, DE L'ARÊTE ET GAUCHISSEMENT) / EBENFLÄCHIGKEIT (KRÜMMUNG DER MITTE, DER KANTE UND VERWINDUNG) / PLANITUD (CURVATURA DEL CENTRO, DE LA ARISTA Y ABARQUILLAMIENTO).   | Squadrato ISO 13006   | ±0,4 %                            | ±1,8 mm   | ±0,20 %                      | ISO 10545-2  |
|   | QUALITÀ DELLA SUPERFICIE / SURFACE QUALITY / QUALITÉ DE LA SURFACE / QUALITÄT DER OBERFLÄCHE / CALIDAD DE LA SUPERFICIE.  | Il 95% min delle piastrelle deve essere esente da difetti visibili. / At least 95% of the tiles must be free from visible flaws. / 95% min des carreaux ne doivent présenter aucun défaut visible. Mindestens 95% der Fliesen müssen frei von sichtbaren min. / el 95% de las baldosas tiene que estar exento de defectos visibles.     |                                   | CONFORME/CONFORMING CONFORME/KONFORM/CONFORME                                   |                              | ISO 10545-2  |
|   | MASSA D'ACQUA ASSORBITA IN % / % WATER ABSORPTION - MASSE D'EAU ABSORBÉE EN % / WASSERAUFNAHME IN % / MASA DE AGUA ABSORBIDA EN %   | < 0,5%  | valore medio 0,08%                |   | ISO 10545-3                  |  |
|   | FORZA DI ROTTURA IN N (sp. < 7,5 mm) - BREAKING STRENGTH IN N (thickness < 7,5 mm) / FORCE DE RUPTURE EN N (ép. < 7,5 mm) / BRUCHLAST IN N (Dicke < 7,5 mm) / FUERZA DE ROTURA EN N (gr. < 7,5 mm).   | ≥ 700 N   | valore medio 1350 N               |   | ISO 10545-4                  |  |
|   | RESISTENZA ALLA FLESSIONE IN N/mm <sup>2</sup> / N/mm <sup>2</sup> FLEXURAL STRENGTH TEST / RÉSISTANCE A LA FLEXION EN N/mm <sup>2</sup> / BIEGESTÄRKE IN N/mm <sup>2</sup> / RESISTENCIA A LA FLEXIÓN EN N/mm <sup>2</sup>   | 35 MIN. N/mm <sup>2</sup>   | valore medio 52 N/mm <sup>2</sup> |   | ISO 10545-4                  |  |
|   | RESISTENZA ALL'ABRASIONE PROFONDA DELLE PIASTRELLE NON SMALTATE / RESISTANCE TO DEEP ABRASION OF UNGLAZED TILES / RESISTENCIA A LA ABRASION PROFONDA DE LAS BALDOSAS SIN ESMALTAR.  | < 175 mm <sup>3</sup>   | valore medio 140 mm <sup>3</sup>  |   | ISO 10545-6                  |  |
|   | RESISTENZA AGLI SBALZI TERMICI / THERMAL SHOCKS RESISTANT / RÉSISTANCE AUX VARIATIONS THERMIQUES / TEMPERATURWECHSELBESTÄNDIGKEIT / RESISTENCIA AL CHOQUE TÉRMICO.  | Metodo di prova disponibile / Available testing method<br>Méthode d'essai disponible / Verfügbare Prüfmethode<br>Método de ensayo disponible  |                                   | RESISTE - RÉSISTANT<br>RÉSISTE - ERFÜLLT - RESISTE                              | ISO 10545-9                  |  |
|   | RESISTENZA AL GELO / FROST RESISTANCE / RÉSISTANCE AU GEL / FROSTSICHERHEIT / RESISTENCIA A LA HELADA.  | RICHIESTA - REQUIRED<br>REQUIRE - GEFORDERT - REQUERIDA   |                                   | RESISTE - RÉSISTANT<br>RÉSISTE - ERFÜLLT - RESISTE                              | ISO 10545-12                 |  |
|   | RESISTENZA ALLE MACCHIE / RESISTANCE TO STAINING / RÉSISTANCE AUX TACHES / FLECKENABWEISEND / RESISTENCIA A LAS MANCHAS.  | Metodo di prova disponibile / Available testing method<br>Méthode d'essai disponible / Verfügbare Prüfmethode<br>Método de ensayo disponible  |                                   | Classe 5  | ISO 10545-14                 |  |
|   | RILASCIO DI SOSTANZE PERICOLOSE / RELEASE OF HAZARDOUS SUBSTANCES / REJET DE SUBSTANCES DANGEREUSES / FREISETZUNG GEFÄHRLICHER STOFFE / LIBERACIÓN DE SUSTANCIAS PELIGROSAS / CADMIO (in mg/dm <sup>2</sup> ) - PIOMBO (in mg/dm <sup>2</sup> )   | VALORE DICHIARATO PER SUPERFICI GL. CON IMPREGHI SU PIANI DI LAVORO / DECLARED VALUE FOR GL SURFACES USED IN WORKTOPS / VALEUR DÉCLARÉE POUR SURFACES GL UTILISÉES SUR PLANS DE TRAVAIL / ANGEBOBENER WERT FÜR GL OBERFLÄCHEN ZUM GEBRAUCH ALS ARBEITSPLÄTZE / VALOR DECLARADO PARA ACABADOS GL UTILIZADOS PARA SUPERFICIES DE TRABAJO. |                                   | CONFORME/CONFORMING<br>CONFORME/KONFORM/CONFORME                                | DM-1-2-2007-Reg-CE-1935-2004 |  |
|   | RESISTENZA A BASSE CONCENTRAZIONI DI ACIDI E ALCALI / RESISTANCE TO LOW CONCENTRATIONS OF ACIDS AND ALKALIS / RESISTENCIA A BASSAS CONCENTRACIONES D'ACIDES ET ALCALIS / WIDERSTAND GEGEN NIEDRIGE KONZENTRATIONEN VON SAUREN UND LAUGEN. / RESISTENCIA A BAJAS CONCENTRACIONES DE ACIDOS Y ALCALIS.  | COME DICHIARATO DAL PRODUTTORE<br>SEE MANUFACTURER'S DECLARATION<br>SELON DÉCLARATION DU PRODUCTEUR<br>ENTSPRECHEND DER HERSTELLERANGABEN TAL COMO DECLARA EL FABRICANTE  |                                   | LB  | LA                           |  |
|   | RESISTENZA AI PRODOTTI CHIMICI DI USO DOMESTICO E AGLI ADDITIVI PER PISCINA / RESISTENCE TO DOMESTIC CHEMICAL PRODUCTS AND ADDITIVES FOR SWIMMING POOLS / RESISTANT AUX PRODUITS CHIMIQUES À USAGE DOMESTIQUE ET AUX ADDITIFS POUR PISCINE / WIDERSTAND GEGEN HAUSHALTSCHIMIKALIEN UND / SCHWIMMBADZUSATZSTOFFEN / RESISTENCIA A PRODUCTOS PARA LIMPIEZA DOMESTICA Y ADITIVOS PARA PISCINAS   | B min   |                                   | A   | ISO 10545-13                 |  |
|   | COEFFICIENTE D'ATTRITO (SCIVOLosità) / FRICTION COEFFICIENT (SLIPPERINESS) / COEFFICIENT DE FRICTION (GLISSEMENT) / REIBUNGSKOEFFIZIENT (SCHLUPFRIGKEIT) / COEFFICIENTE DE ANTI DESLIZAMIENTO.  | -   |                                   | 6° < α ≤ 10°<br>R9  | 10° < α ≤ 19°<br>R10         | DIN EN 16165<br>ANNEX B  |
|   |   | -   |                                   | 18° ≤ α < 24°<br>classe B   | DIN EN 16165<br>ANNEX A      |  |

Per un effetto ottimale della posa, florim suggerisce di mantenere 2 mm di fuga per pose monofornato e 3 mm per combinare formati misti / For optimal installation results, florim recommends maintaining a joint of 2 mm 1/12" for single format installations and 3 mm 1/8" to combine mixed formats / Pour réaliser une pose parfaite, florim suggère de maintenir 2 mm de joint pour la pose des monofornats, et 3 mm pour les combinaisons de formats mixtes / Um einen optimalen effekt beim verlegen zu erzielen empfiehlt florim eine 2 mm fugje bei einformatigen verlegungen und 3 mm fugje bei formatkombinationen / Para lograr los máximos resultados en la posa del producto, florim aconseja 2 mm de junta en aplicaciones monofornato y 3 mm en combinaciones de formatos mixtos.

# CORETECH

GRES FINE PORCELLANATO/FINE PORCELAIN STONWARE/GRES CERAME FIN/FEINSTEINZEUG-KOLLEKTIONEN/GRES PORCELANICO FINO  
SQUADRATO - SQUARED - EQUARRI - REKTIFIZIERT - ESCUADRADO

6 mm 1/4" 

| CARATTERISTICHE TECNICHE - TECHNICAL CHARACTERISTICS - CARACTERISTIQUES TECHNIQUES - TECHNISCHE EIGENSCHAFTEN - CARACTERÍSTICAS TÉCNICAS |   |   |   |         |  |   |                              |
|--|---|---|---|---------|--|---|------------------------------|
|  |   | PRESCRIZIONE<br>STANDARD REQUIREMENTS<br>PRESCRIPTIONS<br>ANFORDERUNGEN<br>PRESCRIPCION | RISULTATI TESTS<br>TEST RESULTS<br>RESULTATS DES ESSAIS<br>PRÜFERGEBNIS<br>RESULTADOS TESTS |         | RIFERIMENTO NORMA<br>REFERENCE STANDARD<br>REFERENCIA NORME<br>STANDARDWERT<br>REFERENCIA NORMA  |   |                              |
|  |   |   | N ≥ 15 cm   |         |  |   |                              |
|  |   |   | (%)   | (mm)    |  | SOFT  | MATTE                        |
|    | LUNGHEZZA E LARGHEZZA: DEVIAZIONE AMMISSIBILE, IN %, DELLA DIMENSIONE MEDIA DI OGNI PIASTRELLA DALLA DIM. DI FABBRICAZIONE / LENGTH AND WIDTH: ADMITTED DEVIATION, IN %, OF THE AVERAGE SIZE OF EACH TILE FROM THE PRODUCTION DIMENSIONS / LONGUEUR ET LARGEUR: MARGE DE TOLÉRANCE, EN %, ENTRE LA DIMENSION MOYENNE DE CHAQUE CARREAU ET LA DIM. DE FABRICATION / LANGE UND BREITE: ZULÄSSIGE ABWEICHUNG DES DURCHSCHNITTMÄßES JEDER FLIESE VOM HERSTELLMAß IN PROZENTEN / LARGO Y ANCHO: DESVIACION ADMISIBLE, EN %, DEL TAMAÑO MEDIO DE CADA BALDOSA A PARTIR DEL TAMAÑO DE FABRICACIÓN. | Squadrato<br>ISO 13006  | ±0,3 %  | ±1,0 mm | ±0,15 %  | ISO 10545-2   |                              |
|  | DEVIAZIONE AMMISSIBILE, IN PERCENTO, DELLO SPESORE MEDIO DI OGNI PIASTRELLA DALLA DIMENSIONE DI FABBRICAZIONE / ADMITTED DEVIATION, IN %, OF THE AVERAGE THICKNESS OF EACH TILE FROM THE PRODUCTION DIMENSIONS / MARGE DE TOLÉRANCE, EN POURCENTAGE, ENTRE L'ÉPAISSEUR MOYENNE DE CHAQUE CARREAU ET LA DIMENSION DE FABRICATION / ZULÄSSIGE ABWEICHUNG DER DURCHSCHNITTSDICKE JEDER FLIESE VOM HERSTELLMAß IN PROZENTEN / DESVIACION ADMISIBLE, EN TANTO POR CIENTO, DEL GROSOR MEDIO DE CADA BALDOSA A PARTIR DEL TAMAÑO DE FABRICACIÓN.   | Squadrato<br>ISO 13006  | ±5 %  | ±0,5 mm | ±5 %   | ISO 10545-2   |                              |
|  | DEVIAZIONE MASSIMA DI RETTILINEARITÀ IN PERCENTO, IN RAPPORTO ALLE DIMENSIONI DI FABBRICAZIONE CORRISPONDENTI / MAXIMUM STRAIGHTNESS DEVIATION, IN %, IN RELATION TO THE CORRESPONDING PRODUCTION DIMENSIONS / MARGE DE TOLÉRANCE DE RECTITUDE, EN POURCENTAGE, PAR RAPPORT AUX DIMENSIONS DE FABRICATION / HÖCHSTABWEICHUNG DER RECHTWINKELIGKEIT IM VERHÄLTNIß ZU DEN ENTSPRECHENDEN HERSTELLMAßEN IN PROZENTEN / DESVIACION MÁXIMA DE RECTITUD, EN TANTO POR CIENTO, EN RELACION CON EL TAMAÑO DE FABRICACIÓN CORRESPONDIENTE.   | Squadrato<br>ISO 13006  | ±0,3 %  | ±0,8 mm | ±0,10 %  | ISO 10545-2   |                              |
|  | DEVIAZIONE MASSIMA DI ORTOGONALITÀ IN PERCENTO, IN RAPPORTO ALLE DIMENSIONI DI FABBRICAZIONE CORRISPONDENTI MAXIMUM RIGHT-ANGLE DEVIATION, IN %, IN RELATION TO THE CORRESPONDING PRODUCTION DIMENSIONS / MARGE DE TOLÉRANCE D'ANGULARITÉ, EN POURCENTAGE, PAR RAPPORT AUX DIMENSIONS DE FABRICATION / HÖCHSTABWEICHUNG DER RECHTWINKELIGKEIT IM VERHÄLTNIß ZU DEN ENTSPRECHENDEN HERSTELLMAßEN IN PROZENTEN / DESVIACION MÁXIMA DE LA ORTOGONALIDAD, EN TANTO POR CIENTO, EN RELACION CON EL TAMAÑO DE FABRICACIÓN CORRESPONDIENTE.  | Squadrato<br>ISO 13006  | ±0,3 %  | ±1,5 mm | ±0,20 %  | ISO 10545-2   |                              |
|  | PLANARITÀ (CURVATURA DEL CENTRO, DELLO SPIGOLO E SVERGOLAMENTO) / FLATNESS (CURVING IN THE MIDDLE, CORNER AND WARPING) / PLANÉITÉ (COURBURE CENTRALE, DE L'ARÊTE ET GAUCHISSEMENT) / EBENFLÄCHIGKEIT (KRÜMMUNG DER MITTE, DER KANTE UND VERWINDUNG) / PLANITUD (CURVATURA DEL CENTRO, DE LA ARISTA Y ABAQUILLAMIENTO).  | Squadrato<br>ISO 13006  | ±0,4 %  | ±1,8 mm | ±0,20 %  | ISO 10545-2   |                              |
|  | QUALITÀ DELLA SUPERFICIE / SURFACE QUALITY / QUALITÉ DE LA SURFACE / QUALITÄT DER OBERFLÄCHE / CALIDAD DE LA SUPERFICIE   |   |   |         | Il 95% min delle piastrelle deve essere esente da difetti visibili. / At least 95% of the tiles must be free from visible flaws. / 95% min des carreaux ne doivent présenter aucun défaut visible. Mindestens 95% der Fliesen müssen frei von sichtbaren min. / el 95% de las baldosas tiene que estar exento de defectos visibles.      | CONFORME/CONFORMING<br>CONFORME/KONFORM/CONFORME      | ISO 10545-2                  |
|    | MASSA D'ACQUA ASSORBITA IN % / % WATER ABSORPTION - MASSE D'EAU ABSORBÉE EN % / WASSERAUFNAHME IN % / MASSA DE AGUA ABSORBIDA EN %  |   | < 0,5%  |         | valore medio 0,08%   | ISO 10545-3   |                              |
|    | FORZA DI ROTTURA IN N (sp. < 7,5 mm) - BREAKING STRENGTH IN N (thickness < 7,5 mm) / FORCE DE RUPTURE EN N (ép. < 7,5 mm) / BRUCHLAST IN N (Dicke < 7,5 mm) / FUERZA DE RÔTURA EN N (gr. < 7,5 mm).   |   | ≥ 700 N   |         | valore medio<br>1350 N   | ISO 10545-4   |                              |
|  | RESISTENZA ALLA FLESSIONE IN N/mm² / N/mm² FLEXURAL STRENGTH TEST / RÉSISTANCE A LA FLEXIÒN EN N/mm² / BIEGEFESTIGKEIT IN N/mm² / RESISTENCIA A LA FLEXIÒN EN N/mm²   |   | 35 MIN. N/mm²   |         | valore medio<br>52 N/mm²   | ISO 10545-4   |                              |
|    | RESISTENZA ALL'ABRASIONE PROFONDA DELLE PIASTRELLE NON SMALTATE / RESISTANCE TO DEEP ABRASION OF UNGLAZED TILES / RÉSISTANCE À L'ABRASION PROFONDE DES CARREAUX NON ÉMAILLÉS / TIEFENABRIEFESTIGKEIT UNGLASIERTER FLIESEN / RESISTENCIA A LA ABRASIÒN PROFUNDA DE LAS BALDOSAS SIN ESMALTAR.  |   | < 175 mm³   |         | valore medio 140 mm³   | ISO 10545-6   |                              |
|    | RESISTENZA AGLI SBALZI TERMICI / THERMAL SHOCKS RESISTANT / RÉSISTANCE AUX VARIATIONS THERMIQUES / TEMPERATURWECHSELBESTÄNDIGKEIT / RESISTENCIA AL CHOCUE TÉRMICO.  |   |   |         | Metodo di prova disponibile / Available testing method<br>Méthode d'essai disponible / Verfügbare Prüfmethode<br>Metodo de ensayo disponible   | RESISTE - RÉSISTANT<br>RÉSISTE - ERFÜLLT - RESISTE    | ISO 10545-9                  |
|    | RESISTENZA AL GEL / FROST RESISTANCE / RÉSISTANCE AU GEL / FROSTSICHERHEIT<br>RESISTENCIA A LA HELADA   |   |   |         | RICHIESTA - REQUIRED<br>REQUIRE - GEFORDERT - REQUERIDA  | RESISTE - RÉSISTANT<br>RÉSISTE - ERFÜLLT - RESISTE    | ISO 10545-12                 |
|    | RESISTENZA ALLE MACCHIE / RESISTANCE TO STAINING / RÉSISTANCE AUX TACHES / FLECKENABWEISEND / RESISTENCIA A LAS MANCHAS.  |   |   |         | Metodo di prova disponibile / Available testing method<br>Méthode d'essai disponible / Verfügbare Prüfmethode<br>Metodo de ensayo disponible   | Classe 5  | ISO 10545-14                 |
|    | RILASCIO DI SOSTANZE PERICOLOSE / RELEASE OF HAZARDOUS SUBSTANCES / REJET DE SUBSTANCES DANGEREUSES / FREISETZUNG GEFÄHRLICHER STOFFE / LIBERACIÒN DE SUSTANCIAS PELIGROSAS / CADMIO (in mg/dm²) - PIOMBO (in mg/dm²)   |   |   |         | VALORE DICHIARATO PER SUPERFICI GL CON IMPREGHI SU PIANI DI LAVORO / DECLARED VALUE FOR GL SURFACES USED ON WORKTOPS / WERT FÜR DEKLARÉE POUR SURFACES GL UTILISÉES SUR PLANS DE TRAVAIL / ANGEBOBENER WERT FÜR GL OBERFLÄCHEN ZUM GEBRAUCH ALS ARBEITSPLÄTEN / WALKOR DECLARADO PARA ACABADOS GL UTILIZADOS PARA SUPERFICIES DE TRABAJO | CONFORME/CONFORMING<br>CONFORME/KONFORM/CONFORME      | DM-1-2-2007-Reg-CE-1935-2004 |
|    | RESISTENZA A BASSE CONCENTRAZIONI DI ACIDI E ALCALI / RESISTANCE TO LOW CONCENTRATIONS OF ACIDS AND ALKALIS / RESISTANCE A BASSES CONCENTRATIONS D'ACIDES ET ALCALIS / WIDERSTAND GEGEN NIEDRIGE KONZENTRATIONEN VON SAUREN UND LAUGEN. / RESISTENCIA A BAJAS CONCENTRACIONES DE ACIDOS Y ALCALIS.  |   |   |         | COME DICHIARATO DAL PRODUTTORE<br>SEE MANUFACTURER'S DECLARATION<br>SELON DÉCLARATION DU PRODUCTEUR<br>ENTSPRECHEND DER HERSTELLERANGABEN<br>TAL COMO DECLARA EL FABRICANTE  | LA  | ISO 10545-13                 |
|    | RESISTENZA AI PRODOTTI CHIMICI DI USO DOMESTICO E AGLI ADDITIVI PER PISCINA / RESISTENCE TO DOMESTIC CHEMICAL PRODUCTS AND ADDITIVES FOR SWIMMING POOLS / RÉSISTANT AUX PRODUITS CHIMIQUES À USAGE DOMESTIQUE ET AUX ADDITIFS POUR PISCINE / WIDERSTAND GEGEN HAUSHALTSCHIMIKALIEN UND / SCHWIMMBADZUSATZSTOFFEN / RESISTENCIA A PRODUCTOS PARA LIMPIEZA DOMESTICA Y ADITIVOS PARA PISCINAS   |   | MIN B   |         | A  |   |                              |
|  |   |   | -   |         | 6° < α ≤ 10°<br>R9   | 10° < α ≤ 19°<br>R10                                  | DIN EN 16165<br>ANNEX B      |
|    | COEFFICIENTE D'ATTRITO (SCIVOLosità) / FRICTION COEFFICIENT (SLIPPERINESS) / COEFFICIENT DE FRICTION (GLISSEMENT) / REIBUNGSKOEFFIZIENT (SCHLUPFRIGKEIT) / COEFFICIENTE DE ANTI DESLIZAMIENTO.  |   | -   |         | -  | 18° ≤ α < 24°<br>classe B<br>(Flame light/Flame dark) | DIN EN 16165<br>ANNEX A      |
|  |   |   | -   |         | > 0,42 wet   |   | ANSI A 326.3                 |

















Per un effetto ottimale della posa, florim suggerisce di mantenere 2 mm di fuga per pose monoformato e 3 mm per combinare formati misti / For optimal installation results, florim recommends maintaining a joint of 2 mm 1/16" for single format installations and 3 mm 1/8" to combine mixed formats / Pour réaliser une pose parfaite, florim suggère de maintenir 2 mm de joint pour la pose des monoformats, et 3 mm pour les combinaisons de formats mixtes / Um einen optimalen effekt beim verlegen zu erzielen empfehlt florim eine 2 mm fuge bei einformatigen verlegungen und 3 mm fuge bei formatkombinationen / Para lograr los máximos resultados en la posa del producto, florim aconseja 2 mm de junta en aplicaciones monoformato y 3 mm en combinaciones de formatos mixtos.



# CARATTERISTICHE TECNICHE

TECHNICAL FEATURES  
CARACTÉRISTIQUES TECHNIQUES  
TECHNISCHE EIGENSCHAFTEN  
CARACTERISTICAS TÉCNICAS

9mm

| CARATTERISTICHE TECNICHE - TECHNICAL CHARACTERISTICS - CARACTERISTIQUES TECHNIQUES - TECHNISCHE EIGENSCHAFTEN - CARACTERÍSTICAS TÉCNICAS  |  |   |  |   |   |              |
|---|--|---|--|---|---|--------------|
| Lastre in gres fine porcellanato non smaltato. Piastrelle di ceramica pressate a secco. Caratteristiche di qualità secondo i test di controllo previsti dalla norma EN 14411-ISO 13006 Appendice G gruppo Bia UGL/ Unglazed porcelain stoneware slabs. Dry-pressed ceramic tiles. Quality specifications, according to control tests of EN 14411-ISO 13006 Appendix G group Bia UGL. / Dalles en grès cérame fin non émaillé. Carreaux céramiques pressés à sec. Caractéristiques de qualité d'après les essais de contrôle norme EN 14411-ISO 13006 Appendice G groupe Bia UGL/ Nicht glasierte und vollständig gesinterter Feinsteinzeugplatten. Trocken gepresste Keramikfliesen. Qualitätseigenschaften nach Normen EN 14411-ISO 13006 Anhang G Gruppe Bia UGL/ Planchas de gres porcelánico fino no esmaltado. Baldosas de cerámica rensadas en seco. Características de calidad según las Normas EN 14411-ISO 13006 Apéndice G grupo B1a UGL. |  | PRESCRIZIONE STANDARD REQUIREMENTS<br>PRESCRIPTIONS ANFORDERUNGEN<br>PRESCRIPCION |  | RISULTATI TESTS<br>TEST RESULTS<br>RESULTATS DES ESSAIS<br>PRÜFERGEBNIS<br>RESULTADOS TESTS | RIFERIMENTO NORMA<br>REFERENCE STANDARD<br>RÉFÉRENCE NORME<br>STANDARDWERT<br>REFERENCIA NORMA        |              |
|   |  | N > 15 cm   |  |   |   |              |
|   |  | (%)   | (mm)   |   |   |              |
|   | LUNGHEZZA E LARGHEZZA: DEVIAZIONE AMMISSIBILE, IN %, DELLA DIMENSIONE MEDIA DI OGNI PIASTRELLA DALLA DIM. DI FABBRICAZIONE / LENGTH AND WIDTH: ADMITTED DEVIATION, IN %, OF THE AVERAGE SIZE OF EACH TILE FROM THE PRODUCTION DIMENSIONS / LONGUEUR ET LARGEUR : MARGE DE TOLÉRANCE, EN %, ENTRE LA DIMENSION MOYENNE DE CHAQUE CARREAU ET LA DIM. DE FABRICATION / LANGE UND BREITE: ZULÄSSIGE ABWEICHUNG DES DURCHSCHNITTMÄßES JEDER FLIESE VOM HERSTELLMÄß IN PROZENTEN / LARGO Y ANCHO: DESVIACION ADMISIBLE, EN %, DEL TAMAÑO MEDIO DE CADA BALDOSA A PARTIR DEL TAMAÑO DE FABRICACION. | Squadrato<br>ISO 13006  | ±0,3 %   | ±1,0 mm   | ±0,15 %   | ISO 10545-2  |
|   | DEVIAZIONE AMMISSIBILE, IN PERCENTO, DELLO SPESORE MEDIO DI OGNI PIASTRELLA DALLA DIMENSIONE DI FABBRICAZIONE / ADMITTED DEVIATION, IN %, OF THE AVERAGE THICKNESS OF EACH TILE FROM THE PRODUCTION DIMENSIONS / MARGE DE TOLÉRANCE, EN POURCENTAGE, ENTRE L'ÉPAISSEUR MOYENNE DE CHAQUE CARREAU ET LA DIMENSION DE FABRICATION / ZULÄSSIGE ABWEICHUNG DER DURCHSCHNITTSDICKE JEDER FLIESE VOM HERSTELLMÄß IN PROZENTEN / DESVIACION ADMISIBLE, EN TANTO POR CIENTO, DEL GROSOR MEDIO DE CADA BALDOSA A PARTIR DEL TAMAÑO DE FABRICACION.  | Squadrato<br>ISO 13006  | ±5 %   | ±0,5 mm   | ±5 %  |              |
|   | DEVIAZIONE MASSIMA DI RETTILINEARITÀ, IN PERCENTO, IN RAPPORTO ALLE DIMENSIONI DI FABBRICAZIONE CORRISPONDENTI / MAXIMUM STRAIGHTNESS DEVIATION, IN %, IN RELATION TO THE CORRESPONDING PRODUCTION DIMENSIONS / MARGE DE TOLÉRANCE DE RECTITUDE, EN POURCENTAGE, PAR RAPPORT AUX DIMENSIONS DE FABRICATION CORRESPONDANTES / ZULÄSSIGE HOCHSTABWEICHUNG DER KANTENGERADHEIT IM VERHÄLTNIS ZU DEN ENTSPRECHENDEN HERSTELLMÄßEN IN PROZENTEN / DESVIACION MÁXIMA DE RECTITUD, EN TANTO POR CIENTO, EN RELACION CON EL TAMAÑO DE FABRICACION CORRESPONDIENTE.                                   | Squadrato<br>ISO 13006  | ±0,3 %   | ±0,8 mm   | ±0,10 %   |              |
|   | DEVIAZIONE MASSIMA DI ORTOGONALITÀ, IN PERCENTO, IN RAPPORTO ALLE DIMENSIONI DI FABBRICAZIONE CORRISPONDENTI / MAXIMUM RIGHT-ANGLE DEVIATION, IN %, IN RELATION TO THE CORRESPONDING PRODUCTION DIMENSIONS / MARGE DE TOLÉRANCE D'ANGULARITÉ, EN POURCENTAGE, PAR RAPPORT AUX DIMENSIONS DE FABRICATION CORRESPONDANTES / HOCHSTABWEICHUNG DER RECHTWINKLIGKEIT IM VERHÄLTNIS ZU DEN ENTSPRECHENDEN HERSTELLMÄßEN IN PROZENTEN / DESVIACION MÁXIMA DE LA ORTOGONALIDAD, EN TANTO POR CIENTO, EN RELACION CON EL TAMAÑO DE FABRICACION CORRESPONDIENTE.                                       | Squadrato<br>ISO 13006  | ±0,3 %   | ±1,5 mm   | ±0,20 %   |              |
|   | PLANARITÀ (CURVATURA DEL CENTRO, DELLO SPIGOLO E SVERGOLAMENTO) / FLATNESS (CURVING IN THE MIDDLE, CORNER AND WARPING) / PLANÉITE (COURBURE CENTRALE, DE L'ARÊTE ET GAUCHISSEMENT) / EBENFLÄCHIGKEIT (KRÜMMUNG DER MITTE, DER KANTE UND VERWINDUNG) / PLANITUD (CURVATURA DEL CENTRO, DE LA ARISTA Y ABRUQUILLAMIENTO).  | Squadrato<br>ISO 13006  | ±0,4 %   | ±1,8 mm   | ±0,35 %   |              |
|   | QUALITÀ DELLA SUPERFICIE - SURFACE QUALITY / QUALITÉ DE LA SURFACE - QUALITÄT DER OBERFLÄCHE / CALIDAD DE LA SUPERFICIE.   |   |  |   | CONFORME/CONFORMING<br>CONFORME/KONFORM/CONFORME.   |              |
|   | MASSA D'ACQUA ASSORBITA IN % / % WATER ABSORPTION - MASSE D'EAU ABSORBÉE EN % / WASSERAUFNAHME IN % / MASA DE AGUA ABSORBIDA EN %  |   | E≤0,5%   |   | valore medio 0,08 %   | ISO 10545-3  |
|    | FORZA DI ROTTURA IN N (sp. ≥ 7,5 mm) - BREAKING STRENGTH IN N (thickness ≥ 7,5 mm) / FORCE DE RUPTURE EN N (ép. ≥ 7,5 mm) / BRUCHLAST IN N (Dicke ≥ 7,5 mm) / FUERZA DE ROTURA EN N (gr. ≥ 7,5 mm)   |   | 1300 min   |   | valore medio 2200 N ( <b>spes.9mm</b> )<br>valore medio 14000 N ( <b>spes.20mm</b> )                  | ISO 10545-4  |
|   | RESISTENZA ALLA FLESSIONE IN N/mm² / N/mm² FLEXURAL STRENGTH TEST / RÉSISTANCE A LA FLEXION EN N/mm² / BIEGEFESTIGKEIT IN N/mm² / RESISTENCIA A LA FLEXIÓN EN N/mm²  |   | 35 MIN. N/mm²  |   | valore medio 50 N/mm² ( <b>spes.9mm</b> )<br>valore medio 52 N/mm² ( <b>spes.20mm</b> )               | ISO 10545-4  |
|   | RESISTENZA ALL'ABRAZIONE PROFONDA DELLE PIASTRELLE NON SMALTATE / RESISTANCE TO DEEP ABRASION OF UNGLAZED TILES / RESISTANCE A L'ABRASION PROFONDE DES CARREAUX NON ÉMAILLÉS / TIEFENABRIEFESTIGKEIT UNGLASIRTER FLIESEN / RESISTENCIA A LA ABRASION PROFUNDA DE LAS BALDOSAS SIN ESMALTAR   |   | <175mm <sup>3</sup>  |   | valore medio 140mm <sup>3</sup>   | ISO 10545-6  |
|   | RESISTENZA AGLI SBALZI TERMICI / THERMAL SHOCKS RESISTANT / RÉSISTANCE AUX VARIATIONS THERMIQUES TEMPERATURWECHSELBESTÄNDIGKEIT / RESISTENCIA AL CHOQUE TÉRMICO.   |   | -  |   | RESISTE - RÉSISTANT<br>RÉSISTE - ERFÜLLT - RESISTE  | ISO 10545-9  |
|   | RESISTENZA ALLE MACCHIE / RESISTANCE TO STAINING / RÉSISTANCE AUX TACHES / FLECKENABWEISEND<br>RESISTENCIA A LAS MANCHAS   |   | -  |   | ≥ Classe 3  | ISO 10545-14 |
|   | RESISTENZA A BASSE CONCENTRAZIONI DI ACIDI E ALCALI. / RESISTANCE TO LOW CONCENTRATIONS OF ACIDS AND ALKALIS. / RESISTANCE A BASSES CONCENTRATIONS D'ACIDES ET ALCALIS. / WIDERSTAND GEGEN NIEDRIGE KONZENTRATIONEN VON SAUREN UND LAUGEN. / RESISTENCIA A BAJAS CONCENTRACIONES DE ACIDOS Y ALCALIS.  |   | COME DICHIARATO DAL PRODUTTORE<br>SEE MANUFACTURERS DECLARATION<br>SELON DECLARATION DU PRODUCTEUR<br>ENTSPRECHEND DER HERSTELLERANGABEN<br>TAL COMO DECLARA EL FABRICANTE |   | vedere la serie - see the collection<br>voir la collection - siehe der kollektion<br>ver la coleccion | ISO 10545-13 |
|   | RESISTENZA A ALTE CONCENTRAZIONI DI ACIDI ED ALCALI / RESISTANCE TO HIGH CONCENTRATIONS OF ACIDS AND ALKALIS / RESISTANCE A HAUTES CONCENTRATIONS D'ACIDES ET BASES / BESTÄNDIGKEIT GEGEN STARK KONZENTRIERTE SAUREN UND LAUGEN. / RESISTENCIA A ALTAS CONCENTRACIONES DE ACIDOS Y ALCALIS   |   | B min  |   | A   |              |
|   | RESISTENZA AL GELO / FROST RESISTANCE - RÉSISTANCE AU GEL / FROSTSICHERHEIT - RESISTENCIA A LA HELADA  |   | RICHIESTA - REQUIRED<br>REQUIRE - GEFORDERT - REQUERIDA  |   | RESISTE - RÉSISTANT<br>RÉSISTE - ERFÜLLT - RESISTE  | ISO 10545-12 |
|   | COEFFICIENTE D'ATTRITO (SCIVOLosità) / FRICTION COEFFICIENT (SLIPPERINESS) / COEFFICIENT DE FRICTION (GLISSEMENT) / REIBUNGSKOEFFIZIENT (SCHLÜPFRIEGKEIT) - COEFICIENTE DE ANTI DESLIZAMIENTO  |   | -  |   | vedere la serie - see the collection<br>voir la collection - siehe der kollektion<br>ver la coleccion | -            |

Per un effetto ottimale della posa, florim suggerisce di mantenere 2 mm di fuga per pose monoformato e 3 mm per combinare formati misti / For optimal installation results, florim recommends maintaining a joint of 2 mm 1/12" for single format installations and 3 mm 1/8" to combine mixed formats / Pour réaliser une pose parfaite, florim suggère de maintenir 2 mm de joint pour la pose des monoformats, et 3 mm pour les combinaisons de formats mixtes / Um einen optimalen effekt beim verlegen zu erzielen empfiehlt florim eine 2 mm fuge bei einformatigen verlegungen und 3 mm fuge bei formatkombinationen / Para lograr los máximos resultados en la posa del producto, florim aconseja 2 mm de junta en aplicaciones monoformato y 3 mm en combinaciones de formatos mixtos.

Per informazioni relative ai dati tecnici su marcatura CE vedere il sito [www.florim.com](http://www.florim.com) / Please refer to our web site [www.florim.com](http://www.florim.com) for technical information related to CE labeling / Pour tout renseignement sur l'avis technique de la marque CE veuillez consulter le site [www.florim.com](http://www.florim.com) / Informationen bezüglich technischer Daten zur Beschriftung CE entnehmen Sie unserer Website [www.florim.com](http://www.florim.com) / Para obtener más información y descargar las marcas CE: [www.florim.com](http://www.florim.com)



# **CERTIFICAZIONI**

CERTIFICATIONS

CERTIFICATIONS

ZERTIFIZIERUNGEN

CERTIFICACIONES



## Certificazioni di sistema / System certification / Certification de système / Systemzertifizierung / Certificación de sistema

La soddisfazione del Cliente, nel rispetto dell'Ambiente e della Sicurezza dei propri collaboratori, è la condizione essenziale per il successo della nostra azienda. Di conseguenza, Florim si impegna a porre come obiettivo prioritario il costante miglioramento dei propri prodotti e servizi. Florim Ceramiche S.p.A SB è la prima azienda nel settore a ottenere la certificazione del proprio Sistema di Gestione della Qualità, dell'Ambiente e della Salute e Sicurezza dei lavoratori e dell'Energia, in base alle norme **UNI EN ISO 9001, UNI EN ISO 14001, ISO 45001 e UNI EN ISO 50001**, relativamente a progettazione, produzione e vendita di piastrelle ceramiche in tutte le tipologie produttive.

Customer satisfaction, together with respect for the environment and for the safety of those who work with us are essential conditions for our company's success. As a result, Florim is committed to making the constant improvement of its products and services a priority. Florim Ceramiche S.p.A SB is the first company in the sector to obtain certification for its Quality Management System, its Environmental Management System and its Management System for the Health and Safety of workers and energy, according to **UNI EN ISO 9001, UNI EN ISO 14001, ISO 45001 and UNI EN ISO 50001** standards, relating to the design, manufacture and sales of ceramic tiles in all of its production types.

La satisfaction du client, dans le respect de l'environnement et de la sécurité de ses collaborateurs, est la condition essentielle au succès de notre entreprise. Florim s'engage donc à faire de l'amélioration constante de ses produits et services un objectif prioritaire. Florim Ceramiche S.p.A SB est la première entreprise du secteur à obtenir la certification de son système de gestion de la qualité, de l'environnement, de la santé et de la sécurité des employés et de l'énergie, conformément aux normes **UNI EN ISO 9001, UNI EN ISO 14001, ISO 45001 et UNI EN ISO 50001**, en matière de conception, production et vente de tous types de carreaux céramiques.

Die Zufriedenheit des Kunden unter Berücksichtigung von Umwelt und Sicherheit unserer Mitarbeiter ist die grundlegende Bedingung für den Erfolg unseres Unternehmens. Demzufolge setzt sich die Firma Florim dafür ein, die ständige Verbesserung ihrer Produkte und Dienstleistungen zum vorrangigen Ziel zu machen. Die Firma Florim Ceramiche S.p.A SB ist das erste Unternehmen in diesem Fachbereich, das die Zertifizierung seines Managementsystems der Qualität, Umwelt und Gesundheit und Sicherheit, und Energie auf Grund der Bestimmungen **UNI EN ISO 9001, UNI EN ISO 14001, ISO 45001 und UNI EN ISO 50001**, in Bezug auf Entwurf, Produktion und Verkauf von Keramikfliesen in allen Herstellungsarten erhielt.

La satisfacción del Cliente, con un respeto total del ambiente y seguridad de sus colaboradores, representa la condición esencial para el éxito de nuestra empresa. Por ello, Florim se compromete a perseguir, como objetivo prioritario, una mejora constante de sus productos y servicios. Florim Ceramiche S.p.A SB es la primera empresa en el sector que ha obtenido el certificado del Sistema de Gestión de la Calidad, Ambiente, Salud y Seguridad de los trabajadores y energía en base a la normativa **UNI EN ISO 9001, UNI EN ISO 14001, BS OHSAS 18001 y UNI EN ISO 50001**, en relación al proyecto, producción y venta de baldosas de cerámica en todas las tipologías productivas.



Sistema di gestione della Qualità:  
**Certificato n° 50 100 1271**

Sistema di gestione dell'Ambiente:  
**Certificato n° 50 100 100 74**

Sistema di gestione della Salute e Sicurezza dei lavoratori:  
**Certificato n° 50 100 13825**

Sistema di gestione dell'Energia:  
**Certificato n° 50 100 13545**

L'ente certificatore è il Technischerhungs-Verein (TÜV), che è stato scelto per la severità e il riconoscimento a livello internazionale.

The certification institute is Technischerhungs-Verein (TÜV), chosen for its stringent standards and international recognition.

L'organisme de certification est le Technischerhungs-Verein (TÜV), qui a été choisi pour sa rigueur et sa reconnaissance au niveau international.

Prüfbehörde ist der Technische Überwachungsverein (TÜV), welcher aufgrund seiner strengen Prüfkriterien und seiner internationalen Bekanntheit gewählt wurde.

El ente certificador es el Technischerhungs-Verein (TÜV), que ha sido elegido por su severidad y su reconocimiento a nivel internacional.





### BUREAU VERITAS

Bureau Veritas è il marchio che certifica la natura riciclata del materiale di cui è composto un prodotto, sottoponendo a verifica l'intero ciclo produttivo. Viene controllata e documentata la provenienza dei materiali di riciclo, il loro dosaggio, il rispetto di alcune peculiarità tecnologiche e il raggiungimento dei parametri stabiliti della norma ISO14021:2002 dell'International Organization for Standardization e

del regolamento LEED del U.S. Green Building Council (USGBC).

Per maggiori informazioni: [www.bureauveritas.com](http://www.bureauveritas.com)

Bureau Veritas is the mark that certifies the recycling of the material that goes into the making of a product, by running an inspection on the entire production cycle. Checks and documentation are carried out on the provenance of the recycled material, the quantities used, the observance of certain technological particulars and the achievement of the parameters established by the ISO14021:2002 regulations of the International Organization for Standardization and the LEED regulation of the U.S. Green Building Council (USGBC). For more information: [www.bureauveritas.com](http://www.bureauveritas.com)

Bureau Veritas est une marque qui certifie que le matériau dont un produit est composé a été recyclé, en soumettant l'ensemble du cycle de production à une vérification. La provenance des matériaux recyclés est contrôlée et prouvée, de même que leur dosage et le respect de certaines caractéristiques technologiques et des paramètres définis par la norme ISO14021:2002 de l'Organisation internationale de normalisation et le règlement LEED de l'U.S. Green Building Council (USGBC). Pour plus d'informations : [www.bureauveritas.com](http://www.bureauveritas.com)

Bureau Veritas ist ein Markenzeichen, das die rezyklierte Art des Materials zertifiziert, aus dem ein Produkt besteht und dazu den gesamten Produktionszyklus prüft. Kontrolliert und beurkundet wird die Herkunft der rezyklierten Materialien, deren Dosierung, die Einhaltung einiger technologischer Eigenschaften und das Erreichen der Parameter, die von den Vorschriften ISO14021:2002 der International Organization for Standardization und von den LEED-Vorschriften des U.S. Green Building Council (USGBC) vorgeschrieben werden. Für weitere Infos siehe: [www.bureauveritas.com](http://www.bureauveritas.com)

Bureau Veritas es la marca que certifica la naturaleza reciclada del material con el que está hecho un producto, sometiendo a control todo el ciclo productivo. Se controla y documenta la proveniencia de los materiales reciclados, su dosificación, que se respeten algunas peculiaridades tecnológicas y que se alcancen los parámetros establecidos por la norma ISO14021:2002 de la International Organization for Standardization y del reglamento LEED del U.S. Green Building Council (USGBC). Para más información: [www.bureauveritas.com](http://www.bureauveritas.com)



**GREENGUARD** Certification is the very first voluntary North American indoor air quality product certification created specifically for commercial building products, this certification requires that products meet stringent chemical emissions requirements for over 360 VOCs, plus a limit on the total of all chemical emissions combined. Products undergo routine monitoring and annual retesting to ensure continued compliance with the GREENGUARD Certification standard.



**GREENGUARD GOLD** Certification was developed with the specific health sensitivities of children and other vulnerable health populations in mind and based on key criteria from public health agencies, this certification sets some of the world's most stringent emission limits on over 360 chemicals, a limit on total chemical emissions, and a limit on phthalate emissions. Products undergo routine monitoring and annual retesting to ensure continued compliance with the GREENGUARD Gold standard.

### GREENGUARD / GREENGUARD GOLD

Per ulteriori informazioni e approfondimenti / For further details and information / Pour approfondir et obtenir de plus amples informations

Für weitere Informationen / Para obtener más información

[www.florim.com](http://www.florim.com)

**Marcatura CE / CE Mark / Marquage CE / CE-Kennzeichnung / Marca CE**



Per ulteriori informazioni, approfondimenti e download delle marcature CE: [www.florim.com](http://www.florim.com)

For further details and information and to download the CE marks: [www.florim.com](http://www.florim.com)

Pour obtenir de plus amples informations, approfondir et télécharger les marquages CE: [www.florim.com](http://www.florim.com)

Für weitere Informationen und Downloads der CE-Kennzeichnungen: [www.florim.com](http://www.florim.com)

Para obtener más información y descargar las marcas CE: [www.florim.com](http://www.florim.com)

**Certificazioni di prodotto nazionali / National product certifications / Certifications de produit nationaux  
Nationale Produktzertifizierungen Certificaciones de producto nacionales**



放射性水平 A 类

Certificazione obbligatoria per l'esportazione in Cina  
Certification mandatory for export to China  
Certification obligatoire pour l'exportation en Chine  
Für den Export nach China obligatorische Zertifizierung  
Certificación obligatoria para la exportación a China

Per soddisfare le richieste di norme e regolamenti locali, vi sono anche diverse certificazioni di prodotto nazionali.

Per informazioni in merito contattare [www.florim.com](http://www.florim.com)

To cater for the requirements of local norms and regulations, various national product certifications also exist. For more details contact [www.florim.com](http://www.florim.com)

Pour satisfaire les exigences des normes et réglementations locales, il existe également différentes certifications nationales de produit.

Pour de plus amples informations à ce sujet contacter [www.florim.com](http://www.florim.com)

Darüber hinaus sind auch verschiedene nationale Produktzertifizierungen vorhanden, um die lokalen Anforderungen bezüglich Richtlinien und Reglementen zu erfüllen. Für Informationen dazu wenden Sie sich bitte an [www.florim.com](http://www.florim.com)

Para satisfacer los requisitos previstos por las normas y reglamentos locales, hay también varias certificaciones de producto nacionales. Para obtener más información, contacte con [www.florim.com](http://www.florim.com)

---



**UPEC**

QB-UPEC

Per informazioni relative ai dati tecnici sulla classificazione UPEC vedi il sito [www.florim.com](http://www.florim.com)

Pour toute information concernant les données techniques sur la classification UPEC, nous vous prions de bien vouloir consulter la version française du site [www.florim.com](http://www.florim.com)



**WallPEC**

QB-WallPEC

Per informazioni relative ai dati tecnici sulla classificazione WallPEC vedi il sito [www.florim.com](http://www.florim.com)

Pour toute information concernant les données techniques sur la classification WallPEC, nous vous prions de bien vouloir consulter la version française du site [www.florim.com](http://www.florim.com)



## U.S. GREEN BUILDING COUNCIL

Florim ha aderito volontariamente all'U.S. Green Building Council (USGBC), la più importante associazione statunitense di industrie appartenenti al settore edilizio, unite per promuovere edifici costruiti in accordo a precise disposizioni riguardanti la sostenibilità ambientale che sono incluse all'interno della certificazione LEED (Leadership in Energy and Environmental Design), un sistema a punteggio che misura la sostenibilità di un progetto. L'utilizzo di prodotti Florim contribuisce a ottenere punti per l'acquisizione della certificazione LEED.

Florim has voluntarily become a member of the U.S. Green Building Council (USGBC), the most important American association dedicated to environmentally sustainable building design and construction according to precise directives, which must be followed in order to obtain LEED (Leadership in Energy and Environmental Design) certification, a rating system that measures the sustainability of a project. Using Florim products contributes to getting points to achieve LEED certification.

Florim a adhéré volontairement à l'U.S. Green Building Council (USGBC), la plus grande association américaine d'industries appartenant à la filière BTP, unies pour promouvoir la réalisation de constructions conformes aux dispositions précises édictées en matière de durabilité environnementale, incluses dans la certification LEED (Leadership in Energy and Environmental Design), un système d'attribution de notes mesurant la durabilité d'un projet. L'utilisation des produits Florim contribue à l'obtention de points en vue de la certification LEED.

Florim ist freiwillig dem U.S. Green Building Council (USGBC) beigetreten, dem bedeutendsten Verband der Bauindustrien in den Vereinigten Staaten, die sich zur Förderung von Gebäuden vereinigt haben, die gewissen Nachhaltigkeitsvorschriften entsprechend gebaut werden. Diese Bestimmungen sind in der LEED-Zertifizierung (Leadership in Energy and Environmental Design), einem Punktesystem zur Bewertung der Nachhaltigkeit eines Projekts, enthalten. Der Gebrauch von Florim Produkten trägt zur Erlangung von Punkten der LEED-Zertifizierung bei.

Florim ha adherido voluntariamente al U.S. Green Building Council (USGBC), la más importante asociación estadounidense de industrias pertenecientes al sector de la construcción, unidas para promover la construcción de edificios de acuerdo con precisas disposiciones relativas a la sostenibilidad ambiental, que están incluidas en la certificación LEED (Leadership in Energy and Environmental Design), un sistema por puntos que mide la sostenibilidad de un proyecto. El uso de productos Florim contribuye a obtener puntos para adquirir la certificación LEED.

---

**La certificazione LEED** è una certificazione di edificio non di prodotto. Pertanto i criteri LEED fanno sempre riferimento al sistema edificio e non ai singoli materiali utilizzati nel progetto. La soglia indicata nei crediti si riferisce quindi al parametro cui l'edificio dovrà conformarsi per l'attribuzione del relativo punteggio. Sul sito Florim.com all'interno delle certificazioni di ogni singola collezione, è disponibile la Certification Letters for LEED® Projects.

**LEED certification** is a building certification and not for a product. Therefore, the LEED criteria always refer to the building system and not to the individual building materials used in the project. The threshold indicated in the credits, therefore refers to the parameter to which the building must comply with for the allocation of the corresponding point score. Certification Letters for LEED® Projects are available on the Florim.com website, in the certifications for each single collection.

**La certification LEED** (« Leadership in Energy and Environmental Design ») est une certification qui concerne les bâtiments et non pas les produits. Ainsi, les critères LEED font toujours référence au système bâtiment et non pas aux matériaux utilisés dans le projet. Le seuil indiqué dans les crédits se réfère donc au paramètre auquel le bâtiment devra se conformer pour l'attribution des points correspondants. Sur le site Florim.com, parmi les certifications de chaque collection, la Certification Letters for LEED® Projects est disponible.

**Bei der LEED-Zertifizierung** handelt es sich nicht um ein Produkt- sondern ein Gebäudezertifizierungssystem. Daher beziehen sich die LEED-Kriterien immer auf das Gebäude im Ganzen, nicht auf die einzelnen für das Projekt verwendeten Materialien. Der für die Punkte angegebene Grenzwert bezieht sich daher auf den Wert, den das Gebäude einhalten muss, um die entsprechenden Punkte zu erhalten. Auf der Website Florim.com finden sich in den Zertifizierungen der einzelnen Kollektionen die Certification Letters for LEED® Projects.

**La certificación LEED** es una certificación para el edificio y no para el producto. Por lo tanto los criterios LEED siempre se refieren al sistema edificio y no a cada uno de los materiales utilizados en el proyecto. El umbral indicado en los créditos se refiere por lo tanto al parámetro al cual el edificio se deberá ajustar para que le sea atribuida la correspondiente puntuación. En el sitio web Florim.com, en la sección de las certificaciones de cada colección, están disponibles las Certification Letters for LEED® Projects.



**ENVIRONMENT PRIORITY ONE** / Using nature's resources responsibly

Per sottolineare l'attenzione e l'impegno verso la tutela dell'ambiente, in accordo con la norma ISO 14021 (Environmental labels and declarations) Florim afferma il proprio impegno nella continua innovazione tecnologica dei processi industriali.

To underline our care for the environment and our pledge to protect it in accordance with the ISO 14021 standards (Environmental labels and declarations), Florim affirms its commitment to continual technological innovation of the industrial processes.

Pour prouver l'attention qu'elle consacre depuis toujours à la protection de l'environnement, en accord avec la norme ISO 14021 (Environmental labels and declarations), la société Florim déclare son engagement dans l'innovation technologique continue des processus industriels.

Die Firma Florim möchte ihre Aufmerksamkeit und ihr Engagement zum Schutz der Umwelt gemäß der ISO-Norm 14021 (Environmental labels and declarations) hervorheben und bekräftigt deshalb, dass sie ständig auf technologische Innovation der Industrieprozesse.

Para subrayar la atención y el compromiso adquirido con la tutela del medio ambiente, de acuerdo con la norma ISO 14021 (Environmental labels and declarations) Florim reafirma su dedicación por la continua innovación tecnológica de los procesos industriales.





SGBP 2018-1991

Il Green Building Council di Singapore crea partnership pubblico-privato per promuovere soluzioni di settore innovative attraverso l'intera catena del valore degli edifici e della costruzione. Attraverso i suoi prodotti di bioedilizia e i programmi di etichettatura dei servizi di edilizia ecologica, SGBC stabilisce standard elevati e parametri di riferimento per le soluzioni di bioedilizia sia a livello locale che regionale per aiutare a costruire città più sostenibili per una vita migliore. In qualità di rappresentante di Singapore nel World Green Building Council, SGBC contribuisce attivamente al movimento globale di bioedilizia condividendo competenze e conoscenze durante conferenze ed eventi internazionali.

The Singapore Green Building Council forges public-private partnerships to foster innovative industry solutions across the entire building and construction value chain. Through its green building product and green building services labelling programmes, SGBC sets high standards and benchmarks for green building solutions both locally and regionally to help build more sustainable cities for better living. As Singapore's representative on the World Green Building Council, SGBC actively contributes to the global green building movement by sharing expertise and knowledge during international conferences and events.

---



## ENVIRONMENTAL PRODUCT DECLARATION

L'EPD è una Dichiarazione Ambientale di Prodotto certificata e verificata in modo indipendente, che esprime in modo trasparente e oggettivo le prestazioni ambientali di un prodotto lungo il suo ciclo di vita, in accordo con lo Standard internazionale ISO14025.

L'EPD è basata su specifiche regole che ne definiscono le metodologie di calcolo: le Product Category Rules (PCR), e non prevede soglie prestazioni.

The EPD is a certified and independently verified Environmental Product Declaration that expresses in a transparent and objective manner the environmental performance of a product throughout its life cycle, in accordance with the International Standard ISO14025.

The EPD is based on specific rules that define the calculation methodologies: the Product Category Rules (PCR), and does not provide for performance thresholds.

La DEP est une Déclaration Environnementale de Produit certifiée et vérifiée de façon indépendante, décrivant de manière transparente et objective les performances environnementales d'un produit tout au long de son cycle de vie, conformément à la norme internationale ISO 14025.

La DEP s'appuie sur des règles spécifiques qui définissent ses méthodes de calcul : les Product Category Rules (PCR), et ne prévoit pas de seuils de performance.

EPD ist eine zertifizierte und unabhängig kontrollierte Produkt-Umwelterklärung, die, übereinstimmend mit der internationalen Norm ISO14025, auf transparente und objektive Weise die Umweltleistungen eines Produkts während seines Lebenszyklus bekundet.

EPD basiert auf spezifischen Regeln, die die Berechnungsmethode festlegen: die Product Category Rules (PCR), die keine Leistungsschwellen vorsehen.

La DAP es una declaración ambiental de producto, certificada y verificada de manera independiente, que informa acerca del desempeño ambiental de un producto a lo largo de su ciclo de vida de forma transparente y objetiva, de conformidad con la norma internacional ISO 14025.

La DAP se basa en reglas específicas que definen sus métodos de cálculo, denominadas Reglas de categoría de producto (RCP), y no prevé umbrales de desempeño.

• Il ciclo di produzione delle lastre ceramiche Florim è completato da una cottura ad alta temperatura (fino a 1250 °C a seconda del prodotto); a tali temperature si verificano reazioni chimico-fisiche tra il supporto della lastra e lo smalto superficiale (dove presente) che portano alla formazione di una struttura fortemente compatta, dura e resistente.

• Nelle normali condizioni di utilizzo di lastre ceramiche Florim, qualsiasi fenomeno che riguarda la dispersione di metalli nell'ambiente è assolutamente da escludere; inoltre, anche nelle più estreme condizioni di lavoro, la rimozione di materiale dalla superficie delle lastre come risultato di abrasione è di fatto trascurabile. In ogni caso, qualsiasi tipo di materiale asportato dalle piastrelle è inerte dal punto di vista tossicologico, non ha impatto sull'ambiente e la sua dispersione non comporta alcun effetto.

• Il risultato di studi specifici ha evidenziato che il livello di radioattività naturale in questi materiali non è fonte di potenziali problemi per le persone che vivono in ambienti pavimentati o rivestiti con piastrelle.

• Le lastre ceramiche Florim sono completamente inerti al fuoco (ad esclusione del gres porcellanato decorato). Non rischiano quindi di subire danneggiamenti in caso di esposizione a fiamme libere e non contribuiscono all'intensificazione e propagazione del fuoco. Non rilasciano sostanze tossiche, gas o fumi di alcun tipo e, in caso di incendio, apportano una significativa protezione alle strutture sulle quali sono applicate, riducendo fortemente lo stress termico alle quali sono sottoposte.

• Le lastre ceramiche Florim non costituiscono una base per la proliferazione di batteri e il loro utilizzo è indicato per luoghi in cui le condizioni di sterilità devono essere facilmente mantenute.

• I detriti provenienti dalla demolizione delle lastre ceramiche sono materiali inerti (non reattivi, chimicamente e fisicamente stabili, resistenti all'esposizione prolungata a condizioni estreme dal punto di vista termico, igrometrico e chimico); tali detriti possono essere collocati nell'ambiente senza rischi particolari e trovare impiego anche nella preparazione di sottofondi, ecc.

• Istruzioni per l'installazione: "Nelle operazioni di posa si raccomanda il taglio a umido o il metodo ad incisione e spacco. Evitare di utilizzare utensili per il taglio a secco durante l'installazione. Tecniche di posa improprie possono esporre il posatore a polveri dannose".

• The Florim ceramic slab production cycle is completed by firing at high temperature (up to 1250°C depending on the product); at these temperatures chemical-physical reactions occur between the slab body and the surface glaze (if applied) that result in the formation of a highly compact, hard and resistant structure.

• Under normal conditions of use of the Florim ceramic slabs, any phenomenon of metal dispersion into the environment is absolutely excluded; what is more, even in the most extreme operating conditions, material coming off the slab surface as a result of abrasion is negligible. In any event, any type of material removed from the tiles is inert from a toxicological point of view, has no impact on the environment and its dispersion has no effect at all.

• The results of specific studies have pointed out that the level of natural radioactivity in these materials is not a source of potential risk for persons that live in houses where floor and wall tiles are laid.

• The Florim ceramic slabs (not applicable to decorated gres porcelain) are 100% fire-inert and there is hence no risk of damage in the event of exposure to naked flames and they do not contribute to fire intensification and propagation. They do not release toxic substances, gases or fumes of any kind and, in case of fire, provide considerable protection to the structures on which they are applied, strongly reducing the thermal stress to which they are subjected.

• The Florim ceramic slabs do not constitute a base for proliferation of bacteria and they are suitable for use in places where it must be easy to maintain sterile conditions.

• The debris resulting from ceramic slab demolition is inert (unreactive, chemically and physically stable, resistant to prolonged exposure to extreme conditions from the thermal, hygrometric and chemical point of view) and can be disposed of in the environment without any particular risk, as well as finding use in the preparation of foundations, etc.

• Installation Instructions: "We recommend wet cutting or the score and snap method during the installation process. Do not dry cut using power tools during the installation process. Improper installation techniques could expose installer to harmful dust".

• Le cycle de fabrication des dalles en céramique Florim est complété par une cuisson à température élevée (jusqu'à 1250°C selon le produit). C'est à cette température qu'ont lieu les réactions physico-chimiques entre le tesson de la dalle et l'émail de surface (s'il est appliqué), aboutissant à la formation d'une structure particulièrement compacte, dure et résistante.

• Dans des conditions normales d'utilisation des dalles en céramique Florim, tout phénomène de dispersion des métaux dans l'environnement est absolument exclu. De plus, même dans des conditions extrêmes de travail, le retrait de matière dû à l'abrasion qui se produit à la surface des dalles est parfaitement négligeable. Le type de matière enlevée est inerte du point de vue toxicologique, il n'a pas d'impact sur l'environnement et sa dispersion n'entraîne aucun effet.

• Des études spécifiques ont montré que le niveau de radio-activité naturelle dans ces matériaux ne représentait pas une source de problèmes potentiels pour les personnes vivant dans des pièces dont les sols ou les murs sont recouverts de carreaux céramiques.

• Les dalles céramiques Florim sont totalement inertes au feu (en excluant le grés cérame décoré). Elles ne risquent donc pas de subir de détérioration en cas d'exposition à des flammes nues et ne contribuent ni à l'intensification ni à la propagation de l'incendie. Elles ne dégagent pas de substances toxiques, gaz ou fumées, de quelque type que ce soit, et, en cas d'incendie, elles constituent une protection significative des structures sur lesquelles elles sont appliquées et réduisent considérablement le choc thermique auquel elles sont soumises.

• Les dalles céramiques Florim ne sont pas une base de prolifération des bactéries et leur utilisation est indiquée dans les locaux où le maintien de conditions de stérilité doit être obtenu simplement.

• Les débris provenant de la démolition des dalles céramiques sont des matériaux inertes (non réactifs, chimiquement et physiquement stables, résistant à l'exposition prolongée à des conditions extrêmes du point de vue thermique, hygrométrique et chimique). Ces débris peuvent être déposés dans l'environnement sans risques particuliers et ils peuvent aussi être utilisés pour la préparation de sous-couches etc.

• Instructions d'installation: "Pendant les opérations de pose nous recommandons pour couper le carreau la découpe à l'eau ou la méthode de l'incision sur le carreau. Pendant les opérations de pose ne pas découper à l'aide d'outils électriques. Les techniques d'installation inadéquates pourraient exposer le carreleur à des poussières nuisibles pour la santé".

- Der Produktionsablauf der Florim Keramikplatten wird durch das Brennen bei hoher Temperatur (bis zu 1250 °C je nach Produkt) vervollständigt; bei diesen Temperaturen treten physikochemische Reaktionen zwischen der Unterlegplatte und der (eventuell vorhandenen) oberflächlichen Glasur ein, die zur Bildung einer sehr kompakten, harten und widerstandsfähigen Struktur führen.
- Bei normalen Gebrauchsbedingungen der Florim Keramikplatten ist jegliche Erscheinung hinsichtlich der Feinverteilung von Metallen absolut ausgeschlossen. Auch bei äußerst extremen Arbeitsbedingungen ist der Abrieb der Plattenoberflächen ganz unbedeutend. Jede Art Material, das von den Fliesen abgetragen wird, ist ungiftig und umweltneutral und seine Zerstreuung hat keine Auswirkungen.
- Spezielle Studien haben ergeben, dass der Pegel der natürlichen Radioaktivität dieser Materialien keine Quelle potentieller Gesundheitsstörungen für die Menschen, die in Räumen mit Boden- und Wandbelägen aus Fliesen leben, darstellt.
- Die Florim Keramikplatten sind vollkommen feuerbeständig (ausgenommen das mit Kaltglasur dekorierte Feinsteinzeug). Es besteht also keine Gefahr, dass sie sich, falls sie freien Flammen ausgesetzt werden, beschädigen und sie tragen nicht zur Verstärkung und Ausbreitung des Feuers bei. Sie geben keine giftigen Substanzen, irgendwelche Gase oder Dünste ab und im Falle eines Brandes bieten sie einen erheblichen Schutz der Strukturen, an denen sie angebracht sind, und verringern stark deren Hitzeschock.
- Die Florim Keramikplatten stellen keinen Boden für die Vermehrung von Bakterien dar und ihr Gebrauch ist an allen Stellen angezeigt, wo es erforderlich ist, leicht die Bedingungen der Sterilität aufrechtzuerhalten.
- Der durch den Abbruch der Keramikplatten verursachte Schutt besteht aus trägen (nicht reaktionsfähigen) Materialien, die chemisch und physikalisch stabil sowie widerstandsfähig gegenüber der langen Exposition unter extremen Bedingungen in thermischer, hygrometrischer und chemischer Hinsicht sind. Dieser Schutt kann ohne besondere Risiken im Freien platziert oder auch zur Vorbereitung von Untergründen usw. verwendet werden.
- Installationsanleitung: "Wir empfehlen das Nassschneiden oder schneiden mit Fliesenschneider während des Installationsvorgangs. Während der Installation nicht mit Flex arbeiten. Unsachgemäße Installationstechniken können dem Installateur schädlichen Staub zufügen."

- El ciclo de producción de las losas cerámicas Florim se completa con una cocción a alta temperatura (hasta 1250 °C en función del producto); a dichas temperaturas se verifican reacciones químico-físicas entre el soporte de la losa y el esmalte superficial (si estuviera presente) que llevan a la formación de una estructura fuertemente compacta, dura y resistente.
- En condiciones de uso normales de las losas cerámicas Florim, debe excluirse cualquier fenómeno concerniente a la dispersión de metales en el ambiente; además, incluso en las condiciones de trabajo más extremas, la pérdida de material de la superficie de las losas debido a la abrasión es, de hecho, del todo insignificante. Como quiera que sea, cualquier tipo de material procedente de las losas es inerte desde el punto de vista toxicológico, no tiene ningún impacto en el ambiente y su dispersión no comporta ningún efecto.
- Estudios específicos han demostrado que el nivel de radiactividad natural en estos materiales no es una fuente de potencial peligro para las personas que viven en ambientes pavimentados o revestidos con azulejos.
- Las losas cerámicas Florim son completamente inertes al fuego (excluido el gres porcelánico decorado). Por lo tanto, en caso de exposición a llamas libres no sufren daños y no contribuyen a la intensificación y a la propagación del fuego. Además, no emiten sustancias tóxicas, gases o humos de ningún tipo y, en caso de incendio, aportan una significativa protección a las estructuras en las que están aplicadas y reducen fuertemente el estrés térmico al cual están sometidas.
- Las losas cerámicas Florim no constituyen una base para la proliferación de bacterias, siendo indicadas para aquellos lugares que requieren unas condiciones de esterilidad fáciles de mantener.
- Los residuos procedentes de la demolición de las losas cerámicas son materiales inertes (no reactivos, químicamente y físicamente estables, resistentes a la exposición prolongada a condiciones extremas desde el punto de vista térmico, higrométrico y químico); dichos residuos pueden colocarse en el ambiente sin riesgos especiales y también pueden utilizarse en la preparación de subcapas, etc.
- Instrucciones de instalación: "Se recomienda el corte húmedo o el método de incisión y división durante las operaciones de colocación. Evite usar herramientas de corte en seco durante la instalación. Las técnicas de colocación inadecuadas pueden exponer al instalador a polvo nocivo".

Su richiesta possono essere forniti logotipi personalizzati, grafiche particolari e motivi decorativi ottenuti con taglio ad acqua. Ad ogni richiesta farà seguito il preventivo e saranno comunicati i termini di consegna.

Upon request we can supply personalized logos, patterns and decorated accents obtained by water jet cuttings. For each request, we shall supply an estimate and confirm the delivery time.

Nous pouvons fournir sur demande des logos, et des motifs obtenus par jets d'eau. Pour chaque demande nous faisons suivre une devis délais de livraison.

Auf Wunsch erhalten Sie Dekormotive; personalisierte Firmenlogos, und Sondergrafik mit Wasserstrahlen. Jede Anfrage bekommt einen Kostenvoranschlag sowie, falls eine Bestellung erteilt wird, die vorhandenen Lieferzeiten.

A solicitud, se pueden facilitar logotipos personalizados, dibujos gráficos particulares y motivos decorativos cortados con chorro de agua. Al recibir el pedido, comunicaremos a nuestros clientes el presupuesto junto a los plazos de entrega.





# **CONDIZIONI GENERALI DI VENDITA**

GENERAL CONDITIONS OF SALE  
CONDITIONS GÉNÉRALES DE VENTE  
ALLGEMEINE GESCHÄFTSBEDINGUNGEN  
CONDICIONES GENERALES DE VENTA



## CONDIZIONI GENERALI DI VENDITA

### 1 NORMATIVA CONTRATTUALE

Le presenti condizioni generali, salvo modificazioni o deroghe concordate per iscritto, disciplinano tutti i contratti di vendita fra Florim Ceramiche S.p.A. SB e l'Acquirente senza che sia necessario un espresso richiamo a esse. Le variazioni delle condizioni generali di vendita, le offerte, gli accordi o gli abbuoni accordati dai nostri agenti o altri intermediari, non sono validi se non accettate per iscritto dalla nostra sede.

### 2 OGGETTO DELLA FORNITURA

La fornitura comprende solamente i materiali, le prestazioni ed i quantitativi specificati nella nostra conferma d'ordine. Il testo della conferma d'ordine Florim Ceramiche S.p.A. SB prevarrà in ogni caso sul testo difforme della eventuale offerta o della ordinazione.

### 3 CONFERMA D'ORDINE

Qualora nella conferma d'ordine Florim Ceramiche S.p.A. SB esistano differenze nei singoli elementi che la compongono rispetto alle intese od alle ordinazioni, l'Acquirente che non abbia contestato per iscritto entro 7gg dalla ricezione della nostra conferma s'intende che l'abbia accettata così come è stata redatta. Il cliente si impegna a comunicare a Florim Ceramiche S.p.A. SB l'eventuale variazione del luogo di destinazione della merce, se diverso da quello citato nella conferma d'ordine, entro e non oltre il giorno previsto per il ritiro presso Florim Ceramiche S.p.A. SB, mediante invio, tramite posta e-mail, dei dati identificativi del destinatario delle merci e del luogo presso il quale dovrà essere effettuata la consegna. In mancanza di tale comunicazione la destinazione originariamente indicata si intende tacitamente confermata.

### 4 PREZZI

I prezzi indicati sui listini Florim Ceramiche S.p.A. SB non sono impegnativi; di conseguenza ci riserviamo il diritto di modificarli prima dell'accettazione dell'ordine. I prezzi pattuiti per ogni singola vendita si intendono al netto, per contanti per consegna franco stabilimento, salvo diversa pattuizione scritta. Se fra la data di ordinazione (anche dopo la conferma d'ordine) e quella di consegna si verificassero aumenti nei costi delle materie prime, della manodopera, dei combustibili, nelle spese di produzione, di trasporto ecc., e in caso di variazione rilevante dei tassi di cambio tra divisa di fatturazione e divisa interna, Florim Ceramiche S.p.A. SB potrà aumentare il prezzo convenuto dandone comunicazione scritta all'Acquirente anche a mezzo posta elettronica. Tuttavia, qualora detto prezzo superi del 20% quello convenuto al momento dell'ordinazione, l'Acquirente potrà recedere dal contratto notificandoci per raccomandata tale sua volontà entro il termine perentorio di 10 gg dal ricevimento dell'avviso dell'aumento di prezzo. In difetto, il nuovo prezzo s'intenderà accettato.

### 5 CONSEGNE

La vendita, salvo diversa pattuizione scritta, è sempre franco stabilimento di Florim Ceramiche S.p.A. SB. La merce viaggia a rischio e pericolo dell'Acquirente ed ogni nostra responsabilità cessa con la consegna al vettore, nei confronti del quale l'Acquirente, effettuate le opportune verifiche, dovrà sporgere eventuali reclami. Le spedizioni, via mare o via terra, concernenti forniture sull'estero, vengono effettuate in base alle condizioni scelte di volta in volta, riportate negli "Incoterms" approvati dalla Camera di Commercio Internazionale.

### 6 TERMINI DI CONSEGNA

I termini di consegna hanno carattere indicativo: eventuali ritardi nelle consegne, interruzioni, sospensioni totali o parziali delle forniture non daranno diritto ad indennizzi o risarcimento danni se non diversamente concordato per iscritto.

### 7 CAMPIONI

I dati figuranti nei documenti illustrativi di Florim Ceramiche S.p.A. SB, così come le caratteristiche dei campioni e i modelli da quest'ultimo inviati all'Acquirente, hanno carattere di indicazioni approssimative. Questi dati non hanno valore impegnativo se non nella misura in cui siano stati espressamente menzionati come tali nell'offerta o nell'accettazione scritta di Florim Ceramiche S.p.A. SB.

### 8 PAGAMENTI

Le fatture di Florim Ceramiche S.p.A. SB possono essere emesse il giorno della fornitura, a cadenza quindicinale o mensile e devono essere pagate al netto alla scadenza pattuita. Ogni e qualsiasi obbligazione di pagamento tra le parti contraenti deve essere adempiuta presso la sede della Florim Ceramiche S.p.A. SB. Eventuali pagamenti fatti ad agenti, rappresentanti o ausiliari di commercio di Florim Ceramiche S.p.A. SB non si intendono effettuati finché le relative somme non pervengano a Florim Ceramiche S.p.A. SB. Il pagamento dovrà essere effettuato, salvo diverso accordo scritto, contestualmente alla consegna, presso l'istituto bancario indicato di Florim Ceramiche S.p.A. SB. Qualsiasi ritardo o irregolarità nel pagamento dà a Florim Ceramiche S.p.A. SB il diritto di sospendere le forniture o di risolvere i contratti in corso, anche se non relativi ai pagamenti in questione, nonché il diritto al risarcimento degli eventuali danni. Florim Ceramiche S.p.A. SB ha comunque diritto – a decorrere dalla scadenza del pagamento, senza necessità di messa in mora – agli interessi moratori sulla misura prevista dal d.lgs. 09/10/2002 n. 231. In caso d'inadempimento, anche solo parziale, gli interessi moratori sull'importo non pagato decorrono dal giorno della consegna anche se il termine di pagamento era stato convenuto a data successiva. Nessuna contestazione o controversia inerente alla qualità della merce, a vizi o difetti, o a qualsiasi altro aspetto del contratto, sarà efficace e potrà essere presa in considerazione, e così pure nessuna azione potrà essere iniziata se non dopo l'avvenuto integrale pagamento del prezzo (clausola solve et repete). Non è ammessa compensazione con eventuali crediti, comunque insorti, nei confronti di Florim Ceramiche S.p.A. SB.

### 9 GARANZIE E RECLAMI

La qualità del materiale ceramico è definita sulla base delle vigenti normative internazionali applicabili alla corrispondente classe di prodotto. Florim Ceramiche S.p.A. SB garantisce la sola merce fornita in prima scelta. Reclami relativi a merce in scelta differente dalla prima (scelta B, commerciale, seconda, terza, secondaria, stock, etc.) non saranno presi in considerazione, né viene data implicitamente od esplicitamente alcun tipo di garanzia su tali materiali. È fatto obbligo all'Acquirente di verificare la merce in termini di qualità e quantità entro a breve tempo dal ricevimento in caso di reclami, dandone comunicazione per iscritto entro e non oltre 8 (otto) giorni dal ricevimento stesso pena la decadenza da ogni diritto. Il materiale considerato difettoso dovrà essere tenuto a disposizione di Florim Ceramiche S.p.A. SB per le verifiche che riterrà opportuno effettuare; ogni ulteriore azione (restituzione, riparazione o altro) dovrà essere da noi preventivamente autorizzata per iscritto. Reclami e richieste di intervento in garanzia dopo la posa in opera non saranno presi in esame nel caso in cui il difetto contestato dovesse risultare palese (es. sbaccate, difetti dimensionali, differenze di tono, ecc.). Si precisa che la prima scelta può contenere piastrelle difettose nel limite del 5% e che la tonalità del materiale fornito può differire dal campione esposto, essendo la ceramica intrinsecamente variabile come aspetto. I reclami imputati a difetti o vizi occulti dovranno essere formalizzati per iscritto entro 8 (otto) giorni dalla scoperta e, in ogni caso, entro un anno dalla consegna, pena la decadenza da ogni diritto alla garanzia e di risarcimento. La comunicazione dovrà contenere, oltre i dati di fatturazione, una precisa descrizione del vizio, un preventivo dei costi di riparazione o modificazione del prodotto; in mancanza di questi dati il reclamo si considera nullo. Qualora il reclamo dovesse risultare infondato l'Acquirente dovrà risarcire Florim Ceramiche S.p.A. SB di tutte le spese sostenute per accertamento (viaggi, perizie, ecc.). L'obbligo di Florim Ceramiche S.p.A. SB è, in ogni caso, limitato alla sostituzione dei soli pezzi difettosi o alla riparazione, con espressa esclusione di ulteriori diversi indennizzi quali, a titolo indicativo ma non limitativo, per costi di rimozione e sistemazione di mobili, attrezzature, macchinari ecc., mancati guadagni per interruzione o sospensione di attività, disagi, danni indiretti ecc.. La presenza di piastrelle difettose non inficia la qualità dell'intera fornitura né comporta l'obbligo della integrale sostituzione. I limiti temporali della durata della garanzia sono quelli stabiliti dal codice civile italiano.

### 10 RISERVO DOMINIO

La vendita della merce viene effettuata con la clausola del riservato dominio; pertanto, nel caso in cui il pagamento, per accordi contrattuali, non debba essere effettuato in tutto o in parte dopo la consegna, i prodotti consegnati restano di proprietà Florim Ceramiche S.p.A. SB fino all'integrale pagamento del prezzo.

### 11 CESSIONE DEL CONTRATTO

L'Acquirente non può cedere la sua posizione nel contratto od in singoli rapporti obbligatori da questo derivanti senza l'accettazione scritta di Florim Ceramiche S.p.A. SB; anche in tal caso l'Acquirente rimane comunque solidalmente responsabile col cessionario per le obbligazioni cedute.

### 12 PROPRIETA' INDUSTRIALE E DISTRIBUZIONE SELETTIVA - LIMITI ALLA RIVENDITA

Florim Ceramiche S.p.A. SB è titolare e legittimo detentore di esclusive relative ai marchi, a disegni e brevetti di invenzione. Al fine di garantire al meglio il rispetto dei diritti esclusivi di Florim Ceramiche S.p.A. SB, nonché le aspettative dei consumatori finali in ordine alle caratteristiche qualitative attese, Florim Ceramiche S.p.A. SB gestisce le forniture dei propri prodotti mediante un sistema di distribuzione selettiva. Le forniture ricevute da Florim Ceramiche S.p.A. SB e dai propri punti vendita selettivi autorizzati sono destinate all'installazione presso l'utente finale e non è consentita altra forma di rivendita a ulteriori intermediari commerciali diversi dagli utenti finali, salvo previa autorizzazione scritta da parte di Florim Ceramiche S.p.A. SB. La rivendita della merce in violazione di tale divieto deve considerarsi pertanto non consentita ed equiparata ad uso illecito dei diritti di proprietà industriale e intellettuale di Florim Ceramiche S.p.A. SB, con diritto di Florim Ceramiche S.p.A. SB di chiederne il sequestro presso qualunque detentore. Florim Ceramiche S.p.A. SB si riserva il diritto di procedere giudizialmente nei confronti di chiunque sia coinvolto in rivendite non autorizzate.

### 13 LEGGE DEL CONTRATTO - FORO COMPETENTE

Il contratto è disciplinato dalla legge italiana, competendo gli usi di settore della Provincia di Modena. Per qualsiasi controversia comunque derivante dal contratto di fornitura, tanto da parte di Florim Ceramiche S.p.A. SB come da parte dell'Acquirente, è esclusivamente competente il Tribunale di Modena. E comunque in facoltà di Florim Ceramiche S.p.A. SB adire forti concorrenti o alternativi.

### 14 SICUREZZA DELLA CATENA LOGISTICA

Florim Ceramiche S.p.A. SB al fine di garantire la sicurezza della catena logistica internazionale richiede ai propri CLIENTI il rispetto di requisiti standard per garantire la sicurezza delle merci nei rapporti contrattuali e per garantire la loro conformità alla normativa AEO - Operatore Economico Autorizzato - Dogane, in tutta la Comunità Europea. I CLIENTI di Florim Ceramiche S.p.A. SB si impegnano a garantire che le merci prese in consegna o consegnate siano spedite o trasportate, immagazzinate, preparate e caricate in locali sicuri e in zone di carico e di spedizione sicure, protette contro manomissioni non autorizzate, utilizzando solo personale interno autorizzato ed opportunamente istruito.

Tutti gli articoli di questo listino sono venduti esclusivamente a scatole complete.

IL PRESENTE LISTINO ANNULLA E SOSTITUISCE I PRECEDENTI

## GENERAL CONDITIONS OF SALE

### 1 CONTRACTUAL REGULATIONS

These general conditions, subject to modifications or waivers agreed in writing, govern all sales contracts between Florim Ceramiche S.p.A. SB and the Purchaser without the need for an express reference to them. Variations in the general conditions of sale, offers, credits or allowances agreed by our agents or other intermediaries, are not valid unless accepted in writing by our head office.

### 2 SUBJECT OF THE SUPPLY

The supply includes only the materials, services and quantities specified in our order confirmation. The text of the Florim Ceramiche S.p.A. SB order confirmation shall prevail in any case over any differing text of the offer or order.

### 3 ORDER CONFIRMATION

If, in the Florim Ceramiche S.p.A. SB order confirmation, there are differences in the individual elements comprising it, compared with the agreements or the orders, the Purchaser is understood to have accepted our confirmation as it was drawn up, unless an objection to it is made in writing within 7 days of receipt of it. The customer undertakes to notify Florim Ceramiche S.p.A. SB of the place of destination of the goods, if different from the address quoted on the order confirmation. In the case of any variation in the place of destination, the identification data of the destination address for the goods and the place where delivery is to be made must be sent by post or email, before the day laid down for collection at Florim Ceramiche S.p.A. SB's premises. If no notification is received, the destination originally shown shall be understood as tacitly confirmed.

### 4 PRICES

The prices shown in the Florim Ceramiche S.p.A. SB price-lists are not binding; we therefore reserve the right to modify them before acceptance of the order. The prices agreed upon for each individual sale are understood as net, for cash and for delivery ex-works, subject to any different written stipulation. If there should be increases in costs of raw materials, labour, fuel, production or transport costs, etc. and in the event of a significant change in the exchange rates between the billing currency and the local currency, between the order date (even after the order confirmation) and the delivery date, Florim Ceramiche S.p.A. SB may increase the agreed price, giving written notification to the Purchaser also by email. However, if this price should exceed the price agreed at the time of order by 20%, the Purchaser may withdraw from the contract by notifying us by registered letter of his desire to do so within the deadline of 10 days from receipt of the notice of price increase. If he fails to do so, the price shall be understood as accepted.

### 5 SHIPMENTS

The sale is always ex-works at the Florim Ceramiche S.p.A. SB premises, unless otherwise agreed in writing. The goods travel at the Purchaser's risk and our liability ends with delivery to the carrier, to whom the Purchaser after performing suitable checks must make any claims that may arise. Shipments by sea or land concerning supplies carried out abroad are performed according to conditions chosen on a time-by-time basis, shown in the "Incoterms" approved by the International Chamber of Commerce.

### 6 DELIVERY TIMES

Delivery times are by way of indication only; any delays in delivery and interruptions and total or partial suspensions of supplies shall not give rise to an entitlement to refunds or claims for compensation unless otherwise agreed in writing.

### 7 SAMPLES

The data shown in the Florim Ceramiche S.p.A. SB illustrative documents, as well as the characteristics of samples and models sent by Florim Ceramiche S.p.A. SB to the Purchaser, is of an approximately indicative nature. This data has no binding value except to the extent to which they were expressly mentioned as such in Florim Ceramiche S.p.A. SB's offer or written acceptance.

### 8 PAYMENTS

Florim Ceramiche S.p.A. SB's invoices can be issued on the day of supply, fortnightly or monthly and must be paid net on the agreed expiry date. Each and every obligation for payment between the contracting parties must be performed at Florim Ceramiche S.p.A. SB's head office. Any payments made to agents, sales representatives or assistants of Florim Ceramiche S.p.A. SB are not considered to have been carried out until the relative sums have reached Florim Ceramiche S.p.A. SB. Payment must be carried out, subject to any other written agreement, at the same time as the delivery; to the bank indicated by Florim Ceramiche S.p.A. SB. Any delay or irregularity in payment gives Florim Ceramiche S.p.A. SB the right to suspend supplies or to terminate current contracts, even if they do not relate to the payments in question, as well as the right to claim any damages. Florim Ceramiche S.p.A. SB is in any case entitled – starting from the payment expiry date, and without the need for notice of default – to the interest on arrears to the extent provided for by Italian Legislative Decree No. 231 of 09/10/2002. In the case of non-fulfilment, even only partial, the interest on arrears for the unpaid amount shall start from the day of delivery even if the payment term was agreed on as a later date. No objection or dispute referring to the quality of the goods or to flaws or defects or to any other aspect of the contract shall be valid and can be taken into consideration; in addition, no action may be started up until after payment has been made of the entire amount of the price (solve et repete clause). Compensation to Florim Ceramiche S.p.A. SB, with any credits, however they may have arisen, is not permitted.

### 9 GUARANTEES AND COMPLAINTS

The quality of the ceramic material is defined on the basis of the prevailing international regulations applicable to the corresponding product class. Florim Ceramiche S.p.A. SB guarantees only goods supplied as prime quality. Complaints relating to goods other than of prime quality ("B" quality, commercial, second, third, secondary, stock, etc.) shall not be taken into consideration, nor will any kind of guarantee be given, either implicitly or explicitly, on these materials. The Purchaser is obliged to check the goods in terms of quality and quantity within a short time after receipt and, in the case of a complaint, to give notification of this in writing no later than 8 (eight) days from receipt of the goods; failure to do so will incur the forfeiture of all rights. Material deemed to be defective must be held at Florim Ceramiche S.p.A. SB's disposal for the checks that it will consider suitable to carry out; any further action (return, repair or other) must be authorized in advance by us in writing. Complaints and requests for intervention under guarantee after the material has been laid shall not be taken into account if the defect reported is evident (e.g. chips, defects of size, differences in colour shade, etc.). It is made clear that the prime quality may contain defective tiles up to a limit of 5% and that the colour shades of the material supplied may differ from the sample displayed, since ceramic is intrinsically variable in appearance. Complaints attributed to latent flaws or defects must be formalized in writing within 8 (eight) days from their discovery and, in any case, within one year from delivery; failure to do so will incur the forfeiture of all rights under the guarantee and to compensation. As well as the invoice details, the notification must contain a precise description of the defect and an estimate of costs for repair or modification of the product; failure to notify this data will cause the complaint to be deemed invalid. If the complaint should prove to be unfounded the Purchaser must reimburse Florim Ceramiche S.p.A. SB for all the expenses incurred for assessment (travelling expenses, surveys, etc.). Florim Ceramiche S.p.A. SB's obligation is, in any case, limited to replacing the defective pieces only or to repairing them, with the express exclusion of other, further indemnities such as, by way of a non-limiting example, for costs of removing and re-installing furniture, equipment, machinery, etc., or loss of earnings for interruption or suspension of business, incidental or consequential damages, etc. The presence of defective tiles does not invalidate the quality of the entire supply, nor does it incur the obligation for its entire replacement. The time limits for the duration of the guarantee are as established by the Italian Civil Code.

### 10 RETENTION OF TITLE

Sale of the goods is carried out with the retention of title clause; therefore if payment, by contractual agreements, must be carried out wholly or in part after delivery, the products delivered remain the property of Florim Ceramiche S.p.A. SB until the entire price has been paid.

### 11 TRANSFER OF CONTRACT

The Purchaser may not transfer his position in the contract or in individual binding agreements deriving from this without Florim Ceramiche S.p.A. SB's written acceptance; also in this case the Purchaser anyway remains jointly liable with the transferee for the obligations transferred.

### 12 INDUSTRIAL PROPERTY AND SELECTIVE DISTRIBUTION - LIMITS ON RESALE

Florim Ceramiche S.p.A. SB is the owner and legal holder of the exclusive rights to brand names, designs and patents. In order to guarantee full respect for Florim Ceramiche S.p.A. SB's exclusive rights, as well as the end consumers' expectations with regard to expected quality characteristics, Florim Ceramiche S.p.A. SB manages the supplies of its products by means of a selective distribution system. Supplies received from Florim Ceramiche S.p.A. SB and from its authorized selective sales outlets are designed for installation at the end user's premises and no other form of resale to further sales agents other than the end users is permitted, unless with Florim Ceramiche S.p.A. SB's prior written authorization. Goods that are re-sold in breach of this provision must therefore be considered as not permitted and treated as an unlawful use of Florim Ceramiche S.p.A. SB's industrial and intellectual property rights, with Florim Ceramiche S.p.A. SB's right to ask for them to be seized at the premises of any holder. Florim Ceramiche S.p.A. SB reserves the right to take legal proceedings against anyone who is involved in unauthorized re-selling.

### 13 LAW GOVERNING THE CONTRACT - PLACE OF JURISDICTION

The contract is governed by Italian law, including the customs of the sector in Modena Province. For any dispute that may in any case derive from the supply contract, either on the part of Florim Ceramiche S.p.A. SB or on the part of the Purchaser, the Modena Court has exclusive competence. Florim Ceramiche S.p.A. SB nevertheless has the right to resort to different or competing judicial authorities.

### 14. SUPPLY CHAIN SECURITY

Florim Ceramiche S.p.A. SB, in order to grant the security of the international supply chain, kindly asks its CUSTOMERS to comply with the security requirements laid down by AEO - Authorised Economic Operator - CUSTOMS - to safeguard the goods in the European Community during the activities of the forward and reverse flows. Florim Ceramiche S.p.A. SB CUSTOMERS undertake to meet the security and safety conditions during the operations of receiving, delivery, distribution, transport and storage, ensuring that the goods are taken into delivery, stocked, transported, prepared and loaded in safe places and in safe loading and shipping areas, well protected against intrusion and manipulation, with the only employ of reliable, authorized and fully trained own personnel

All items on this price list are exclusively sold in complete boxes.

THIS PRICE LIST CANCELS AND REPLACES ANY PREVIOUS ONES



## CONDITIONS GÉNÉRALES DE VENTE

### 1 NORME CONTRACTUELLE

Sauf modifications ou dérogations convenues par écrit, les présentes conditions générales s'appliquent à tous les contrats de vente entre Florim et l'Acquéreur sans qu'il soit nécessaire d'y faire une référence expresse. Les variations des conditions générales de vente, les offres, crédits ou réductions accordés par nos agents ou d'autres intermédiaires ne sont valables que s'ils ont été acceptés par écrit par notre siège.

### 2 OBJET DE LA FOURNITURE

La fourniture correspond uniquement aux matériaux, prestations et quantités spécifiés dans notre confirmation de commande. Le texte de la confirmation de commande de Florim prévaut dans tous les cas par rapport au texte non conforme de la commande ou de l'offre éventuelle.

### 3 CONFIRMATION DE COMMANDE

En cas de divergences des éléments de la confirmation de commande de Florim par rapport aux accords ou aux commandes, l'Acquéreur pourra formuler une réclamation écrite dans les 7 jours suivant la réception de notre confirmation. Passé ce délai, la commande sera considérée comme ayant été acceptée telle qu'elle a été rédigée. Le client s'engage à communiquer à Florim Ceramiche S.p.A. SB, l'éventuelle variation du lieu de destination de la marchandise, si différente de celle prévue dans la confirmation de la commande, au plus tard le jour prévu du retrait chez Florim Ceramiche S.p.A. SB, par l'envoi, par poste, ou e-mail, des données d'identification du destinataire des marchandises et du lieu où la livraison devra être effectuée. En cas de manquement de communication la destination indiquée à l'origine sera tacitement confirmée.

### 4 PRIX

Les prix indiqués sur les catalogues Florim Ceramiche S.p.A. SB ne sont pas contraignants; nous nous réservons par conséquent le droit de les modifier préalablement à l'acceptation de la commande. Les prix conenus pour chaque vente s'entendent hors taxes, payés au comptant pour une livraison franco usine, sauf accord contraire stipulé par écrit. Si des hausses du coût des matières premières, de la main-d'œuvre, des combustibles, des frais de production et de transport, etc. et en cas d'une importante variation des taux de change entre la devise de facturation et la devise intermédiaire apparaissent entre la date de commande (même après la confirmation de commande) et la date de livraison, Florim Ceramiche S.p.A. SB pourra augmenter le prix convenu en informant l'Acquéreur par écrit, y compris par courrier électronique. Cependant, si ledit prix dépasse de 20% celui convenu lors de la commande, l'Acquéreur pourra résilier le contrat en nous faisant part de sa volonté par lettre recommandée dans un délai préemptoire de 10 jours à compter de la réception de l'avis d'augmentation du prix. Dans le cas contraire, le nouveau prix sera considéré comme ayant été accepté.

### 5 LIVRAISONS

La vente, sauf accord différent indiqué par écrit, s'entend toujours franco usine Florim Ceramiche S.p.A. SB. La marchandise voyage aux risques et périls de l'Acquéreur. Toutes nos responsabilités prennent fin avec la remise au transporteur, auquel l'Acquéreur, après les contrôles de rigueur, devra s'adresser pour d'éventuelles réclamations. Les expéditions de fournitures à l'étranger par voie terrestre ou maritime sont effectuées selon les conditions choisies d'une fois sur l'autre, conformément aux Incoterms approuvés par la Chambre de commerce internationale.

### 6 DÉLAIS DE LIVRAISON

Les délais de livraison sont donnés à titre indicatif: les éventuels retards de livraison, les interruptions, les suspensions totales ou partielles de fourniture n'ouvriront pas droit à une indemnisation ou à des dommages-intérêts, sauf accord contraire stipulé par écrit.

### 7 ÉCHANTILLONS

Les informations reportées sur les documents d'illustration de Florim Ceramiche S.p.A. SB, de même que les caractéristiques des échantillons et modèles envoyés par Florim Ceramiche S.p.A. SB à l'Acquéreur, sont données à titre purement indicatif. Ces données n'ont aucune valeur contraignante, à moins que cela ait été indiqué expressément dans l'offre ou dans l'acceptation écrite de Florim Ceramiche S.p.A. SB.

### 8 PAIEMENTS

Les factures de Florim Ceramiche S.p.A. SB, peuvent être émises le jour de la fourniture, à cadence bimensuelle ou mensuelle doivent être payées conformément à l'échéance prévue. Toute obligation de paiement entre les parties contractantes doit être exécutée auprès du siège de Florim Ceramiche S.p.A. SB. Les paiements éventuels faits à des agents, représentants ou auxiliaires de commerce de Florim Ceramiche S.p.A. SB ne seront considérés comme effectifs qu'à compter de la réception par Florim Ceramiche S.p.A. SB des sommes dues. Sauf accord contraire stipulé par écrit, le paiement devra être effectué au moment de la livraison auprès de l'institut bancaire indiqué par Florim Ceramiche S.p.A. SB. Tout retard ou toute irrégularité de paiement donnera à Florim Ceramiche S.p.A. SB le droit de suspendre les fournitures ou de résilier les contrats en cours, y compris ceux qui ne sont pas en lien avec les paiements en question, et de demander le remboursement des dommages éventuellement subis. Florim Ceramiche S.p.A. SB peut quoi qu'il en soit prétendre – à compter de l'arrivée à échéance du paiement, et sans nécessité de mise en demeure – à des intérêts moratoires conformément à la loi n° 231 du 09/10/2002. En cas de manquement même partiel, les intérêts moratoires sur le montant restant dû courent à compter du jour de la livraison, même si le délai de paiement convenu est fixé à une date ultérieure. Toute réclamation ni aucun litige portant sur la qualité de la marchandise, des vices ou des défauts ou tout autre aspect du contrat, n'aura de valeur et ne pourra être pris en considération, de même qu'aucune action ne pourra être initiée avant le paiement intégral du prix (clause solve et repete). Les compensations par d'éventuels crédits, même existants, vis-à-vis de Florim Ceramiche S.p.A. SB, ne sont pas admises.

### 9 GARANTIES ET RÉCLAMATIONS

La qualité des matériaux céramiques est définie sur la base des normes internationales en vigueur qui s'appliquent à la classe de produit correspondant. Les garanties de Florim Ceramiche S.p.A. SB ne portent que sur la marchandise de premier choix fournie. Les réclamations relatives à des marchandises autres que celles de premier choix (choix B, commercial, 2e et 3e choix, secondaire, stock, etc.) ne seront pas prises en considération. Il ne sera donné aucun type de garantie sur ces matériaux, ni implicitement ni explicitement. Obligation est faite à l'Acquéreur de contrôler la qualité et la quantité de la marchandise rapidement après la livraison et, en cas de réclamation, d'en donner communication par écrit dans les 8 (huit) jours suivant la réception sous peine de déchéance de ses droits. Les matériaux considérés comme défectueux devront être laissés à la disposition de Florim Ceramiche S.p.A. SB pour les contrôles jugés opportuns; toute action ultérieure (restitution, réparation ou autre) devra avoir été préalablement autorisée par écrit par nos soins. Les réclamations et demandes d'intervention en garantie postérieures à la pose ne seront pas prises en considération si le défaut constaté est manifeste (ex. pièces ébréchées, défauts dimensionnels, différences de teinte, etc.). Il est précisé que le premier choix peut présenter des carreaux défectueux dans une limite de 5% et que la teinte du matériau fourni peut différer de l'échantillon exposé, l'aspect de la céramique étant intrinsèquement variable. Les réclamations pour des défauts ou des vices cachés devront être adressées par écrit dans les 8 (huit) jours suivant leur découverte, et dans tous les cas dans l'année suivant la livraison, sous peine d'une déchéance de tout droit à la garantie et au remboursement. La réclamation devra mentionner, outre les références de facturation, une description précise du vice et un devis des coûts de réparation ou de modification du produit; en l'absence de ces informations, la réclamation sera considérée comme nulle et non avenue. Si la réclamation se révèle infondée, l'Acquéreur devra rembourser à Florim Ceramiche S.p.A. SB tous les dépens engagés dans le cadre des contrôles (déplacements, expertises, etc.) effectués. Les obligations de Florim Ceramiche S.p.A. SB se limitent qu'il en soit au remplacement des pièces défectueuses ou à leur réparation, à l'exclusion expresse de toute indemnisation ultérieure comme, à titre indicatif mais sans limitation aucune, pour des coûts de déplacement et de remise en place de mobilier, de matériel, de machines, etc., de manques à gagner du fait d'une interruption ou d'une suspension d'activité, de perturbations, de dommages indirects, etc. La présence de carreaux défectueux n'invalide pas la qualité de l'ensemble de la fourniture et n'entraîne aucune obligation de remplacement intégral. Les limites temporelles de la durée de garantie sont celles définies par le code civil italien.

### 10 RÉSERVE DE PROPRIÉTÉ

La vente de la marchandise s'effectue avec la clause de réserve de propriété. Par conséquent, si le paiement, du fait d'accords contractuels, est effectué en tout ou partie après la livraison, les produits livrés resteront la propriété de Florim Ceramiche S.p.A. SB jusqu'au paiement intégral du prix.

### 11 CESSIION DU CONTRAT

L'Acquéreur ne peut pas céder ses droits et obligations ni chacune des relations obligatoires nés du présent contrat sans l'accord écrit de Florim Ceramiche S.p.A. SB; même dans ce cas, l'Acquéreur restera solidaire du cessionnaire vis-à-vis des obligations cédées.

### 12 PROPRIÉTÉ INDUSTRIELLE ET DISTRIBUTION SÉLECTIVE - LIMITES À LA REVENTE

Florim Ceramiche S.p.A. SB est le titulaire et propriétaire légitime des exclusivités relatives aux marques, dessins et brevets d'invention. Pour garantir au mieux le respect des droits exclusifs de Florim Ceramiche S.p.A. SB et les attentions du consommateur final en matière de caractéristiques qualitatives, Florim Ceramiche S.p.A. SB gère la fourniture des produits par l'intermédiaire d'un système de distribution sélective. Les fournitures acquises auprès de Florim Ceramiche S.p.A. SB et de ses points de vente sélectifs agréés sont destinées à une installation auprès de l'utilisateur final; aucune autre forme de revente à des intermédiaires commerciaux autres que les utilisateurs finals n'est autorisée, sauf autorisation préalable de Florim Ceramiche S.p.A. SB stipulée par écrit. Toute revente de marchandise en violation de ce principe doit donc être considérée comme interdite et assimilée à un usage illicite des droits de propriété industrielle et intellectuelle de Florim Ceramiche S.p.A. SB, donnant droit à Florim Ceramiche S.p.A. SB de demander la saisie de ladite marchandise auprès de son détenteur. Florim Ceramiche S.p.A. SB se réserve le droit de poursuivre en justice quiconque serait impliqué dans des reventes non autorisées.

### 13 LOI APPLICABLE ET JURIDICTION COMPÉTENTE

Le contrat est régi par la loi italienne, y compris les Usages de branche de la Province de Modène. Le tribunal de Modène est exclusivement compétent pour tout litige relatif au contrat de fourniture entre Florim Ceramiche S.p.A. SB et l'Acquéreur. Florim Ceramiche S.p.A. SB garde néanmoins la faculté de saisir des juridictions concurrentes ou alternatifs.

### 14 SÛRETÉ DANS LA CHAÎNE LOGISTIQUE

FLORIM CERAMICHE S.P.A. SB, afin d'assurer la sûreté de la logistique internationale, demande à ses CLIENTS le respect des standards des rapports contractuels pour assurer la sûreté des biens et leur conformité aux normes de la OEA (Operateur Economique Agréé – Douanes) dans tous les pays de l'Union Européenne. Les CLIENTS de Florim Ceramiche S.p.A. SB s'engagent à veiller à ce que la marchandise prise en charge ou livrée soit expédiée ou transportée, stockée, préparée et chargée dans des dépôts sûres et sur des endroits de chargement et d'expédition sûres, bien protégée contre possibles manipulations pas autorisées, et n'utilisant que du personnel autorisée et possiblement bien qualifié.

L'ensemble des articles de ce catalogue sont vendus exclusivement par paquets entiers.

LE PRÉSENT CATALOGUE ANNULE ET REMPLACE LES PRÉCÉDENTS

## ALLGEMEINE GESCHÄFTSBEDINGUNGEN

### 1 VERTRAGSVORSCHRIFTEN

Diese Allgemeinen Geschäftsbedingungen gelten, vorbehaltlich schriftlich vereinbarter Änderungen oder Abweichungen, für alle Verkaufverträge zwischen Florim Ceramiche S.p.A. SB und dem Käufer ohne ausdrückliche Bezugnahme auf sie. Die Änderungen der allgemeinen Geschäftsbedingungen, die Angebote, die von unseren Handelsagenten oder anderen Vermittlern gewährten Gutschriften oder Nachlässe haben nur Gültigkeit, sofern sie von unserem Sitz schriftlich angenommen wurden.

### 2 GEGENSTAND DER LIEFERUNG

Die Lieferung umfasst nur die Materialien, Leistungen und Mengen, die in unserer Auftragsbestätigung angegeben sind. Der Text der Auftragsbestätigung von Florim Ceramiche S.p.A. SB hat auf jeden Fall Vorrang gegenüber dem Text, der von dem eventuellen Angebot oder der Bestellung abweichen sollte.

### 3 AUFTRAGSBESTÄTIGUNG

Falls in der Auftragsbestätigung von Florim Ceramiche S.p.A. SB Unterschiede der darin aufgelisteten einzelnen Elemente gegenüber den Vereinbarungen oder Bestellungen bestehen, gilt die Bestätigung in ihrer abgefassten Form als angenommen, sofern der Käufer sie nicht binnen 7 Tagen nach Erhalt unserer Bestätigung schriftlich beanstandet hat.

### 4 PREISE

Die auf den Florim Ceramiche S.p.A. SB -Preislisten angeführten Preise sind unverbindlich; Demzufolge behalten wir uns das Recht vor, sie vor der Auftragsannahme abzuändern. Sofern keine anderen schriftlichen Vereinbarungen vorliegen, verstehen sich die für jeden Einzelverkauf vereinbarten Preise netto, gegen bar, Lieferung ab Werk. Sollten zwischen dem Bestelldatum (auch nach der Auftragsbestätigung) und dem Lieferdatum ein Kostenanstieg der Rohstoffe, Löhne, Brennstoffe, Herstellung, des Transports usw. auftreten, oder im Falle einer wesentlichen Änderung der Wechselkurse zwischen der Rechnungswährung und der lokalen Währung, kann Florim Ceramiche S.p.A. SB den vereinbarten Preis erhöhen, indem er dies dem Käufer schriftlich, auch mittels E-Mail, mitteilt. Sollte besagter Preis jedoch den bei der Bestellung vereinbarten Preis um 20% übersteigen, hat der Käufer die Möglichkeit, vom Vertrag zurückzutreten, indem er uns binnen der bindenden Frist von 10 Tagen nach Erhalt der Mitteilung bez. des Preisanstiegs seinen Willen per Einschreiben meldet. In Ermangelung dessen gilt der neue Preis als angenommen.

### 5 LIEFERUNGEN

Der Verkauf, sofern nicht schriftlich anders vereinbart, ist immer ab Florim Ceramiche S.p.A. SB-Werk. Der Warentransport erfolgt auf Risiko und Gefahr des Käufers. Unsere Haftung endet mit der Übergabe an den Frachtführer, an den der Käufer nach angemessener Überprüfung eventuelle Beanstandungen zu richten hat. Auslandslieferungen auf dem See- oder Landweg werden auf der Grundlage von Fall zu Fall gewählten Bedingungen vorgenommen, die in den von der Internationalen Handelskammer gebilligten "Incoterms" aufgeführt sind.

### 6 LIEFERBEDINGUNGEN

Die Lieferbedingungen sind hinweisend: Eventuelle Lieferverzögerungen, Unterbrechungen, komplette oder partielle Einstellungen der Lieferungen berechtigen weder zu einer Entschädigung noch zu einem Schadensersatz, sofern keine anderen schriftlichen Vereinbarungen vorliegen.

### 7 MUSTER

Die auf den veranschaulichenden Dokumenten von Florim Ceramiche S.p.A. SB abgebildeten Angaben sowie die Eigenschaften der vom Letztgenannten dem Käufer zugesandten Muster und Modelle sind als ungefähre Angaben zu verstehen und behält sich nicht um verbindliche Angaben, sofern sie nicht ausdrücklich als derartig im Angebot oder in der schriftlichen Annahme von Florim Ceramiche S.p.A. SB erwähnt wurden.

### 8 ZAHLUNGEN

Die Rechnungen von Florim Ceramiche S.p.A. SB können am Tag der Lieferung ausgestellt werden, 14-tägig oder monatlich und sind netto innerhalb der vereinbarten Frist zu bezahlen. Jegliche Zahlungsverpflichtung zwischen den Parteien besteht am Florim Ceramiche S.p.A. SB -Sitz zu erfüllen, eventuell an Handelsagenten, Vertreter oder Geschäftshelfer von Florim Ceramiche S.p.A. SB geleistete Zahlungen verstehen sich so lange als nicht vorgenommen, bis die bezüglichen Summen bei Florim Ceramiche S.p.A. SB eingehen. Die Bezahlung hat, vorbehaltlich anderer schriftlicher Vereinbarungen, unmittelbar nach der Lieferung beim Bankinstitut zu erfolgen, das von Florim Ceramiche S.p.A. SB angegeben wurde. Jegliche Zahlungsverzögerungen und -unregelmäßigkeiten geben Florim Ceramiche S.p.A. SB das Recht, die Lieferungen einzustellen oder die laufenden Verträge aufzulösen, auch wenn sie sich nicht auf die zutreffenden Zahlungen beziehen, sowie das Recht auf den Ersatz etwaiger Schäden. Florim Ceramiche S.p.A. SB hat auf jeden Fall Anspruch auf die Verzugszinsen – ab der Verzugsfrist und ohne die Notwendigkeit einer Inverzugsetzung – in der laut Gesetzesverordnung Nr. 231 vom 09.10.2002 vorgesehenen Höhe. Im Falle einer auch nur teilweisen Nichterfüllung laufen die Verzugszinsen für den nicht bezahlten Betrag ab dem Tag der Lieferung, auch wenn als Zahlungsfrist ein späteres Datum vereinbart wurde. Keine Beanstandung oder Streitigkeit bezüglich der Warenqualität, Mängel oder Defekte, oder jedes anderen Vertragsaspekts ist wirksam und kann in Betracht gezogen werden, und gleichermaßen kann keine Klage eingeleitet werden, sofern keine vollständige Bezahlung des Preises erfolgte (Klausel solve et repete). Die Verrechnung mit eventuell entstandenen Forderungen gegen Florim Ceramiche S.p.A. SB ist unzulässig.

### 9 GARANTIE UND BEANSTANDUNGEN

Die Qualität des Keramikmaterials wird auf der Grundlage der geltenden internationalen Rechtsvorschriften festgelegt, die auf die jeweilige Produktklasse Anwendung finden. Florim Ceramiche S.p.A. SB garantiert nur die als erste Wahl gelieferte Ware. Beanstandung über die nicht zur ersten Klasse gehörenden Waren (B-Wahl, kommerzielle, zweite, dritte, zweitrangige Wahl, Lagerbestand, usw.) bleiben unberücksichtigt, wobei auf diese Materialien keine Art von Garantie, weder implizit noch explizit, erteilt wird. Der Käufer ist verpflichtet, die Ware binnen kurzer Zeit ab Erhalt der Ware auf Qualität zu prüfen und bei einer Beanstandung dies schriftlich binnen spätestens 8 (acht) Tagen ab Warenerhalt mitzuteilen, da andernfalls jeglicher Anspruch verwirkt. Die als fehlerhaft betrachtete Ware ist Florim Ceramiche S.p.A. SB für seine als angemessen betrachteten Überprüfungen verfügbar zu halten; jeder weitere Vorgang (Rückerstattung, Reparatur oder sonstiges) bedarf unserer vorherigen schriftlichen Genehmigung. Beanstandungen und Beantragungen von Garantieeingriffen nach erfolgter Verlegung werden nicht in Betracht gezogen, sofern sich der beanstandete Defekt als offensichtlich erweisen sollte (zum Beispiel Schlagstellen, Maßunterschiede, Tonabweichungen, usw.). Es wird präzisiert, dass die erste Wahl bis zu 5% fehlerhafte Fliesen enthalten und die Färbung und die Farbgebung des gelieferten Materials vom ausgestellten Muster abweichen darf, da Keramik von Natur aus unterschiedlich aussehen kann. Auf verborgene Fehler oder Mängel bezogene Beanstandungen sind schriftlich binnen 8 (acht) Tagen ab ihrer Feststellung und auf jeden Fall binnen einem Jahr ab Lieferung zu formalisieren, da andernfalls die Verwirkung jeglichen Anspruchs auf Garantie und Entschädigung droht. Die Mitteilung muss neben den Rechnungsdaten eine genaue Beschreibung des Mangels und einen Kostenvoranschlag der Reparatur oder Änderung des Produkts enthalten; in Ermangelung dieser Angaben wird die Beanstandung als nichtig betrachtet. Sollte sich die Beanstandung als unbegründet erweisen, muss der Käufer Florim Ceramiche S.p.A. SB alle für die Überprüfung aufgetragenen Kosten (Reisen, Sachverständigen-Gutachten, usw.) vergüten. Die Pflicht von Florim Ceramiche S.p.A. SB beschränkt sich auf jeden Fall allein auf den Ersatz nur der fehlerhaften Teile oder auf die Reparatur, mit ausdrücklichem Ausschluss anderweitiger Entschädigungen wie beispielsweise - aber nicht ausschließlich - für Kosten zur Beseitigung und Wiederherrichtung von Möbeln, Ausrüstungen, Maschinen, usw., eingangene Gewinne wegen Tätigkeitsunterbrechung oder -einstellung, Unannehmlichkeiten, Folgeschäden, usw. Das Vorhandensein fehlerhafter Fliesen setzt weder die Güte der Gesamtlieferung herab noch ist damit die Pflicht des Gesamtsatzers verbunden. Die zeitlichen Beschränkungen der Garantiedauer sind laut dem italienischen Bürgerlichen Gesetzbuch festgelegt.

### 10 EIGENTUMSVORBEHALT

Der Warenverkauf erfolgt mit der Klausel des Eigentumsvorbehalts; deshalb bleiben die gelieferten Produkte, sofern deren Bezahlung laut Vertragsvereinbarungen gänzlich oder teilweise nach der Lieferung zu erfolgen hat, bis zur vollkommenen Bezahlung des Preises Eigentum von Florim Ceramiche S.p.A. SB.

### 11 VERTRAGSABTRETUNG

Der Käufer darf seine Stellung im Vertrag oder in einzelnen, aus diesem herrührenden obligatorischen Verhältnissen ohne schriftliche Einwilligung von Florim Ceramiche S.p.A. SB nicht abtreten; Auch in diesem Fall haftet der Käufer weiterhin mit dem Übernehmer solidarisch für die abgetretenen Verpflichtungen.

### 12 GERWERBLICHES EIGENTUM UND SELEKTIVER VERTRIEB BESCHRÄNKUNGEN BEIM WEITERVERKAUF

Florim Ceramiche S.p.A. SB ist Inhaber und rechtmäßiger Besitzer von Alleinrechten bezüglich Marken, Zeichnungen und Erfinderpapenten. Um die Beachtung der Alleinrechte von Florim Ceramiche S.p.A. SB und die Ansprüche der Endkunden im Hinblick auf die erwarteten Güteeigenschaften auf ein Höchstmaß gewährleisten zu können, liefert Florim Ceramiche S.p.A. SB seine Produkte im Rahmen eines selektiven Vertriebsystems. Die von Florim Ceramiche S.p.A. SB und seinen dazu befugten selektiven Verkaufsstellen gelieferten Produkte sind für die Verlegung beim Endbenutzer bestimmt. Eine andere Form des Weiterverkaufs an weitere Handelsvermittler, die nicht den Endbenutzern entsprechen, ist ohne vorherige schriftliche Einwilligung von Florim Ceramiche S.p.A. SB unzulässig. Die Ware, dessen Weiterverkauf trotz dieses Verbots erfolgte, ist somit als unzulässig zu betrachten und einem unerlaubten Gebrauch der gewerblichen und geistigen Eigentumsrechte von Florim Ceramiche S.p.A. SB gleichzusetzen, wobei Florim Ceramiche S.p.A. SB berechtigt ist, die Beschlagnahme bei jedem Besitzer zu beantragen. Florim Ceramiche S.p.A. SB behält sich das Recht vor, gegen all diejenigen gerichtlich vorzugehen, die an einem unbefugten Weiterverkauf beteiligt sind.

### 13 VERTRAGSGESETZ - ZUSTÄNDIGES GERICHT

Der Vertrag ist durch das italienische Gesetz, einschließlich der Branchengewohnheiten der Provinz Modena, geregelt. Für jegliche aus dem Liefervertrag herrührende Streitigkeit sowohl seitens Florim Ceramiche S.p.A. SB als auch des Käufers ist allein das Gericht Modena zuständig. Es ist jedoch in der Fakultät von Florim Ceramiche S.p.A. SB, konkurrierende oder alternative Foren anzurufen.

### 14 SICHERHEIT DES LOGISTISCHEN ABLAUF

Um die Sicherheit des internationalen Logistikablaufs zu gewährleisten, verlangt Florim Ceramiche S.p.A. SB von seinen KUNDEN, dass sie sich an die Standardanforderungen halten, um die Sicherheit von Waren in vertraglichen Beziehungen zu gewährleisten und um die Einhaltung mit dem AEO - Authorized Economic Operator - Zollwesen, in der gesamten Europäischen Gemeinschaft sicherzustellen. Die Florim Ceramiche S.p.A. SB-KUNDEN verpflichten sich, zu gewährleisten, dass die übernommenen oder gelieferten Waren in sicherem Gelände und in sicheren Lade- und Versandbereichen versandt, transportiert, gelagert oder verladen, und vor unbefugter Manipulation geschützt werden, wobei nur autorisiertes und entsprechend ausgebildetes Personal eingesetzt werden darf.

Alle Artikel dieser Preisliste werden nur in ganzen Kartons verkauft.

DIE VORLIEGENDE PREISLISTE ANNULLIERT UND ERSETZT DIE VORHERIGEN PREISLISTEN.

## CONDICIONES GENERALES DE VENTA

### 1 NORMATIVA CONTRACTUAL

Salvo modificaciones o derogaciones acordadas por escrito, las presentes condiciones generales disciplinan todos los contratos de venta entre Florim Ceramiche S.p.A. SB y el Comprador sin necesidad de una referencia expresa a ellos. Las variaciones de las condiciones generales de venta, ofertas, bonificaciones o descuentos, acordados por nuestros agentes o por otros intermediarios, solo son válidas previa aceptación escrita de nuestra empresa.

### 2 OBJETO DEL SUMINISTRO

El suministro comprende solamente los materiales, prestaciones y cantidades especificados en nuestra confirmación de pedido. El texto de la confirmación de pedido de Florim Ceramiche S.p.A. SB prevalecerá siempre sobre el texto de cualquier oferta o pedido.

### 3 CONFIRMACIÓN DE PEDIDO

Si la confirmación de pedido de Florim Ceramiche S.p.A. SB difiere de los acuerdos o pedidos en cuanto a los elementos que la componen, el Comprador podrá enviar la correspondiente reclamación por escrito en el plazo de 7 días a partir de la recepción de nuestra confirmación; en caso contrario, esta se considerará aceptada tal como ha sido redactada. Si el lugar de entrega de la mercancía es diferente del indicado en la confirmación de pedido, el cliente se compromete a comunicarlo a Florim Ceramiche S.p.A. SB antes del día previsto para el retiro en la sede de esta última. Dicha comunicación se debe realizar por correo, telefax o correo electrónico, y debe incluir los datos identificativos del destinatario de los bienes y del lugar en el que se debe realizar la entrega. En defecto de esta comunicación, el destino indicado originalmente se considera tácitamente confirmado.

### 4 PRECIOS

Los precios indicados en las listas Florim Ceramiche S.p.A. SB no son vinculantes: en consecuencia, nos reservamos el derecho a modificarlos antes de la aceptación del pedido. Los precios acordados para cada venta son netos, con pago en efectivo y entrega franco fábrica, salvo acuerdo escrito en contrario. Si entre la fecha del pedido (incluso después de la confirmación de la entrega) y la fecha de entrega se verificaran aumentos en los costes de las materias primas, mano de obra, combustibles, gastos de producción, transporte, etc. y en caso de variaciones importantes en los tipos de cambio entre la divisa de facturación y la divisa interna, Florim Ceramiche S.p.A. SB podrá aumentar el precio acordado, comunicándolo por escrito al Comprador (también por telefax o correo electrónico). Si dicho precio supera en un 20 % el acordado en el momento del pedido, el Comprador podrá rescindir el contrato, comunicando su decisión por correo certificado en el plazo perentorio de 10 días a partir de la recepción de la notificación de aumento de precio. En su defecto, el nuevo precio se considerará aceptado.

### 5 ENTREGAS

La venta, salvo acuerdo escrito en sentido contrario, siempre es franco fábrica Florim Ceramiche S.p.A. SB. La mercancía viaja a cargo y riesgo del Comprador. Toda responsabilidad nuestra cesa en el momento de la entrega al transportista, ante el cual, una vez realizados los controles necesarios, el Comprador deberá plantear sus eventuales reclamaciones. Los envíos al exterior, por vía marítima o terrestre, se realizan según las condiciones establecidas en cada caso, indicadas en los "Incoterms" aprobados por la Cámara de Comercio Internacional.

### 6 PLAZOS DE ENTREGA

Los plazos de entrega tienen carácter indicativo; eventuales retrasos de las entregas, interrupciones y suspensiones totales o parciales de los suministros no darán derecho a indemnizaciones o resarcimientos de daños, salvo acuerdo escrito en contrario.

### 7 MUESTRAS

Los datos indicados en los documentos ilustrativos de Florim Ceramiche S.p.A. SB, así como las características de las muestras y modelos enviados por este último al Comprador, tienen carácter indicativo. Estos datos no tienen valor vinculante, excepto en la medida en que hayan sido expresamente mencionados como tales en la oferta o en la aceptación escrita de Florim Ceramiche S.p.A. SB.

### 8 PAGOS

Las facturas de Florim Ceramiche S.p.A. SB pueden ser emitidas el día de suministro, con cadencia quincenal o mensual y su importe neto debe ser pagado en el plazo acordado. Todas las obligaciones de pago entre las partes contrayentes se deben cumplir en la sede de Florim Ceramiche S.p.A. SB. Eventuales pagos efectuados a agentes, representantes o auxiliares de comercio de Florim Ceramiche S.p.A. SB no se considerarán realizados hasta el momento en que las sumas correspondientes sean acreditadas a Florim Ceramiche S.p.A. SB. Salvo acuerdo escrito en contrario, el pago se deberá realizar en el momento de la entrega, en el banco indicado por Florim Ceramiche S.p.A. SB. Cualquier retraso o irregularidad en el pago da a Florim Ceramiche S.p.A. SB derecho a suspender los suministros o a resolver los contratos en curso, incluso si no corresponden a los pagos incumplidos, así como al resarcimiento de los eventuales daños. En todo caso, a partir del vencimiento del pago y sin necesidad de declaración de mora, Florim Ceramiche S.p.A. SB tiene derecho a percibir los intereses de mora en la medida prevista por el decreto legislativo N.º 231 del 09/10/2002. En caso de incumplimiento, incluso parcial, los intereses de mora sobre el importe no pagado se calcularán a partir del día de la entrega, incluso si el plazo de pago había sido acordado en una fecha posterior. Ninguna reclamación o controversia inherente a la calidad de la mercancía, imperfecciones, defectos o cualquier otro aspecto del contrato será eficaz ni podrá ser tomada en consideración, y ninguna acción podrá ser iniciada, hasta el pago integral del precio (cláusula solve et repete). No se admiten compensaciones con eventuales créditos de cualquier naturaleza ante Florim Ceramiche S.p.A. SB.

### 9 GARANTÍAS Y RECLAMACIONES

La calidad del material cerámico se define sobre la base de las normas internacionales aplicables a la clase de producto correspondiente. Florim Ceramiche S.p.A. SB garantiza solo la mercancía de primera calidad. Reclamaciones relativas a mercancía de otras calidades (calidad B, comercial, segunda, tercera, secundaria, existencias, etc.) no serán tomadas en consideración, ni se dará ningún tipo de garantía —implícita o explícita— sobre dicho material. El Comprador tiene la obligación de verificar la calidad y cantidad de la mercancía en breve plazo después de su recepción y, en caso de reclamarlo, comunicarlo por escrito en el plazo de 8 (ocho) días a partir de la recepción, bajo pena de caducidad de cualquier derecho. El material considerado defectuoso deberá ser puesto a disposición de Florim Ceramiche S.p.A. SB para los controles que considere necesarios; cualquier otra acción (restitución, reparación, etc.) deberá ser autorizada previamente por Florim Ceramiche S.p.A. SB en forma escrita. Las reclamaciones y solicitudes de intervención en garantía después de la colocación no serán consideradas en el caso de que el defecto reclamado resulte manifiesto (por ejemplo: desportilladuras, defectos dimensionales, diferencias de tono, etc.). Se señala que la primera calidad puede contener hasta un 5 % de baldosas defectuosas y que el tono del material suministrado puede diferir de la muestra expuesta, dado que la cerámica es intrínsecamente variable en su aspecto. Las reclamaciones por defectos o imperfecciones ocultos deberán ser formalizadas por escrito en el plazo de 8 (ocho) días a partir de su descubrimiento y, en todo caso, en el plazo de un año a partir de la entrega, bajo pena de caducidad de cualquier derecho a garantía y resarcimiento. Además de los datos de facturación, la comunicación deberá contener una precisa descripción del defecto y un presupuesto de los costes de reparación o modificación del producto; en ausencia de estos datos, la reclamación se considerará nula. Si la reclamación resulta infundada, el Comprador deberá resarcir a Florim Ceramiche S.p.A. SB todos los gastos realizados para la verificación (viajes, peritajes, etc.). En todo caso, la obligación de Florim Ceramiche S.p.A. SB se limita a la sustitución de las piezas defectuosas o a la reparación, quedando expresamente excluidas otras indemnizaciones, como - a título indicativo, no limitativo - costes de desplazamiento y relocalización de mobiliario, equipo, maquinaria, etc., lucro cesante debido a la interrupción o suspensión de actividades, molestias, daños indirectos, etc. La presencia de baldosas defectuosas no afecta la calidad del suministro en su conjunto, ni comporta la obligación de su sustitución integral. La duración de la garantía es la establecida por el código civil italiano.

### 10 RESERVA DE DOMINIO

La venta de la mercancía se realiza con cláusula de reserva de dominio; por lo tanto, si los acuerdos contractuales prevén que el pago debe ser realizado - total o parcialmente - después de la entrega, los productos entregados seguirán siendo propiedad de Florim Ceramiche S.p.A. SB hasta el pago integral del precio.

### 11 CESIÓN DEL CONTRATO

El Comprador no puede ceder su posición en el contrato ni en relaciones obligatorias eventualmente derivadas del mismo, sin la aceptación escrita de Florim Ceramiche S.p.A. SB. En tal caso, el Comprador seguirá siendo responsable solidariamente con el cesionario de las obligaciones cedidas.

### 12 PROPIEDAD INDUSTRIAL Y DISTRIBUCIÓN SELECTIVA - LÍMITES DE REVENTA

Florim Ceramiche S.p.A. SB es titular y legítimo poseedor de la exclusividad de las marcas, dibujos y patentes de invención. Con el objetivo de garantizar adecuadamente el respeto de los derechos exclusivos de Florim Ceramiche S.p.A. SB, así como las expectativas de los consumidores finales en cuanto a las características cualitativas previstas, Florim Ceramiche S.p.A. SB controla la distribución de sus productos mediante un sistema de distribución selectiva. Los suministros enviados por Florim Ceramiche S.p.A. SB y por los puntos de venta autorizados están destinados a la instalación por parte del usuario final, no está permitida ninguna forma de reventa a otros intermediarios comerciales diferentes de los usuarios finales, salvo previa autorización escrita de Florim Ceramiche S.p.A. SB. Por lo tanto, la reventa de mercancía que viole esta prohibición se debe considerar no permitida y equiparada a un uso ilícito de los derechos de propiedad industrial e intelectual de Florim Ceramiche S.p.A. SB, con derecho de esta última a solicitar la incautación de la mercancía a cualquier poseedor. Florim Ceramiche S.p.A. SB se reserva el derecho a proceder judicialmente contra todo aquel que esté involucrado en reventas no autorizadas.

### 13 LEY DEL CONTRATO - TRIBUNAL COMPETENTE

El contrato está disciplinado por la ley italiana, incluidos los Usos del Sector de la Provincia de Módena. Para cualquier controversia derivada del contrato de suministro, tanto por parte de Florim Ceramiche S.p.A. SB como por parte del Comprador, tiene competencia exclusiva el Tribunal de Módena. No obstante, es facultad de Florim Ceramiche S.p.A. SB recurrir a foro competidores o diferentes.

### 14 SEGURIDAD DE LA CADENA LOGÍSTICA

Florim Ceramiche S.p.A. SB, con la finalidad de garantizar la seguridad de la cadena logística internacional, les ruega a sus propios CLIENTES el respeto de unos requisitos estándar para garantizar la seguridad de las mercancías objeto de relaciones contractuales y para garantizar su conformidad con la normativa AEO - Operador Económico Autorizado - Aduanas, en toda la Comunidad Europea. Los CLIENTES de Florim Ceramiche S.p.A. SB se comprometen a garantizar que las mercancías recogidas en consigna o consignadas sean expedidas o transportadas, almacenadas, preparadas o cargadas en locales seguros y en zonas de carga y expedición seguras, protegidas contra manumisiones no autorizadas, utilizando solo personal interno autorizado y oportunamente instruido.

**Todos los artículos del presente listín se venden exclusivamente en cajas completas.**

**EL PRESENTE LISTÍN ANULA Y SUSTITUYE LOS LISTINES ANTERIORES.**



**Quanto contenuto nel catalogo è indicativo e non esaustivo riguardo alle grafiche, decori e ai colori riportati.**

Contents of this catalog is indicative and not exhaustive with regard to graphics, decors and colors shown.

Le contenu du catalogue est indicative et non exhaustive en ce qui concerne graphiques, décors et couleurs indiquées.

Die Beschreibungen im Katalog sind indikativ und nicht allumfassend in Bezug auf Grafiken, Dekore und Farben.

El contenido de este catálogo es indicativo y no exhaustivo con respecto a gráficas, decoros y colores ilustrados.







**Florim Ceramiche S.p.A. SB**

Via Canaletto, 24 / 41042 Fiorano Modenese (MO) / T. +39 0536 840111 / [florim.com](http://florim.com)